

SIZE TABLE
TIANA'S CLOSET SEWING PATTERNS

Size code	XXS	XS	S	M	L	XL	XXL	3XL	4XL	5XL	
Bust	centimeter	80	84	88	92	96	100	104	110	116	122
	inch	31.5	33.1	34.6	36.2	37.8	39.4	40.9	43.3	45.7	47.2
Waist	centimeter	60	64	68	72	76	80	84	90	96	102
	inch	23.6	25.2	26.8	28.3	29.9	31.5	33.1	35.4	37.8	40.2
Hip	centimeter	88	92	96	100	104	108	112	118	124	130
	inch	34.6	36.2	37.8	39.4	40.9	42.5	44.1	46.5	49.6	52.0

PRINTING INSTRUCTIONS

- Tiana's Closet sewing patterns are made in Layered PDF format, which means all sizes are saved in one file and can be shown or hidden. It is recommended to use Adobe Acrobat Reader (paid version on Mac OS, free on Windows) or Foxit PDF Reader (free, works on Windows only) to read the file correctly. In order to choose the desired size(s), go to Layers tab of your PDF reader, uncheck all boxes except for the desired size(s) and the box Print for all sizes.
- When printing the pattern, go to Print settings, in the tab Scale choose Custom scale: 100% (or Scaling: None or Actual Size) to print true to size. Note: some computers print smaller than true size even when you choose 100% scale, so you will have to adjust the scale to a little larger than 100% and measure the test square until you get the true size.
- The test square is 10 centimeters (horizontally) and 4 inches (vertically).
- Always print the first page of the file and measure to avoid waste of paper.
- After printing the pattern, cut the pages along the lines with scissors icon, align and tape the pages according to their sequences. For example, page 1A is taped to page 1B in a row, and page 1A is taped to page 2A in a column. Please see the image below to see how the pages line up.
- You can find photo instruction for printing sewing patterns on Tiana's Closet website: <https://tianas-closet.com/index.php/how-to-print-tianas-closet-patterns/>

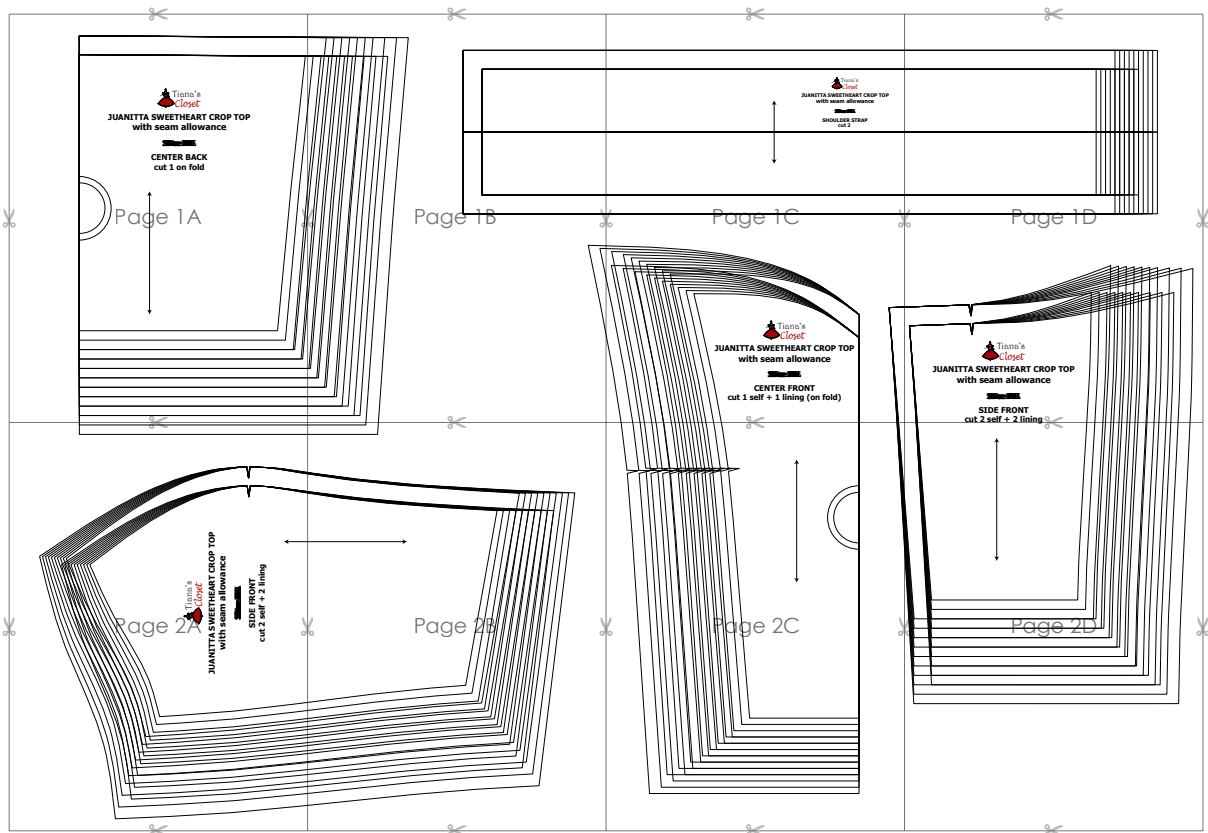



**JUANITTA SWEETHEART CROP TOP
with seam allowance**

~~Size 10~~

**CENTER BACK
cut 1 on fold**

Page 1A

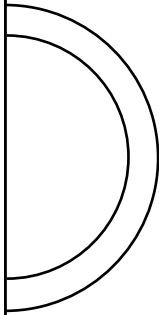

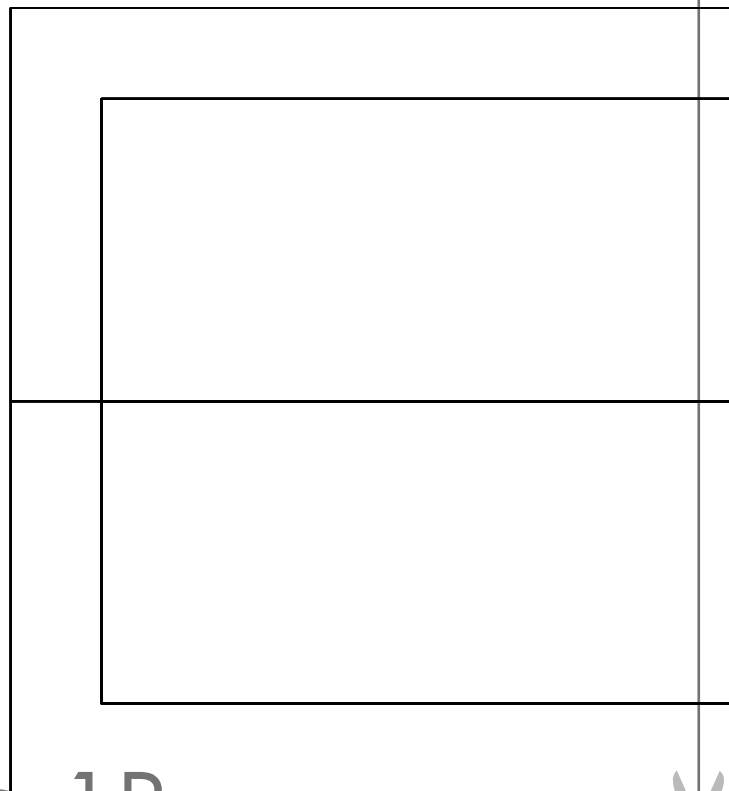
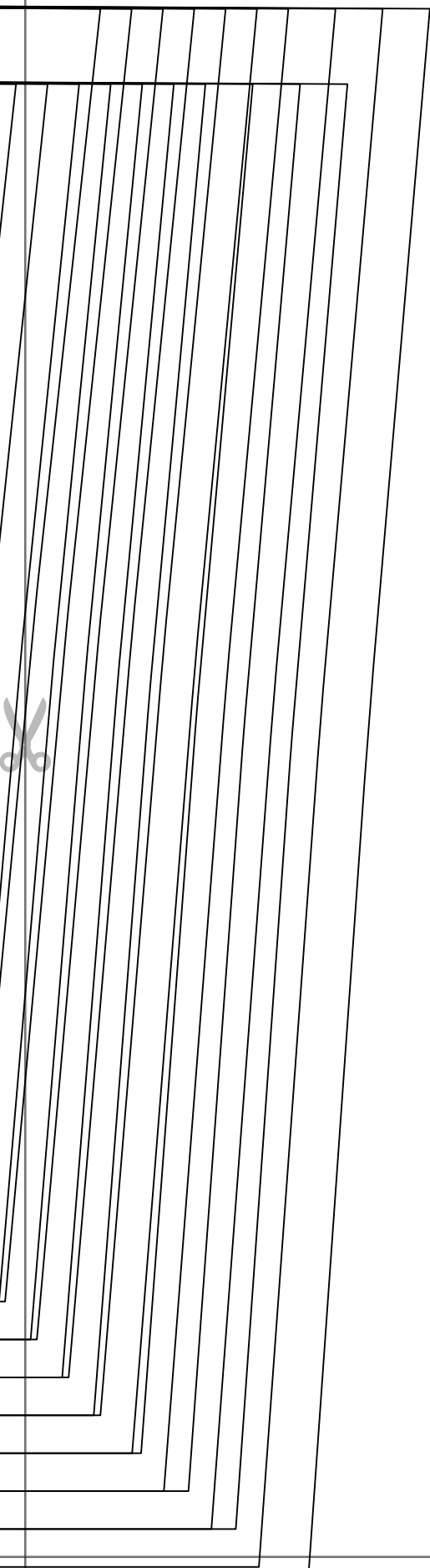

Page 1B





**JUANITA SWEETHEART CROP TOP
with seam allowance**

~~Size M~~

**SHOULDER STRAP
cut 2**



Page 1C



**JUANITA SWEETHEART CROP TOP
with seam allowance**

~~Size M~~

**CENTER FRONT
cut 1 self + 1 lining (on fold)**



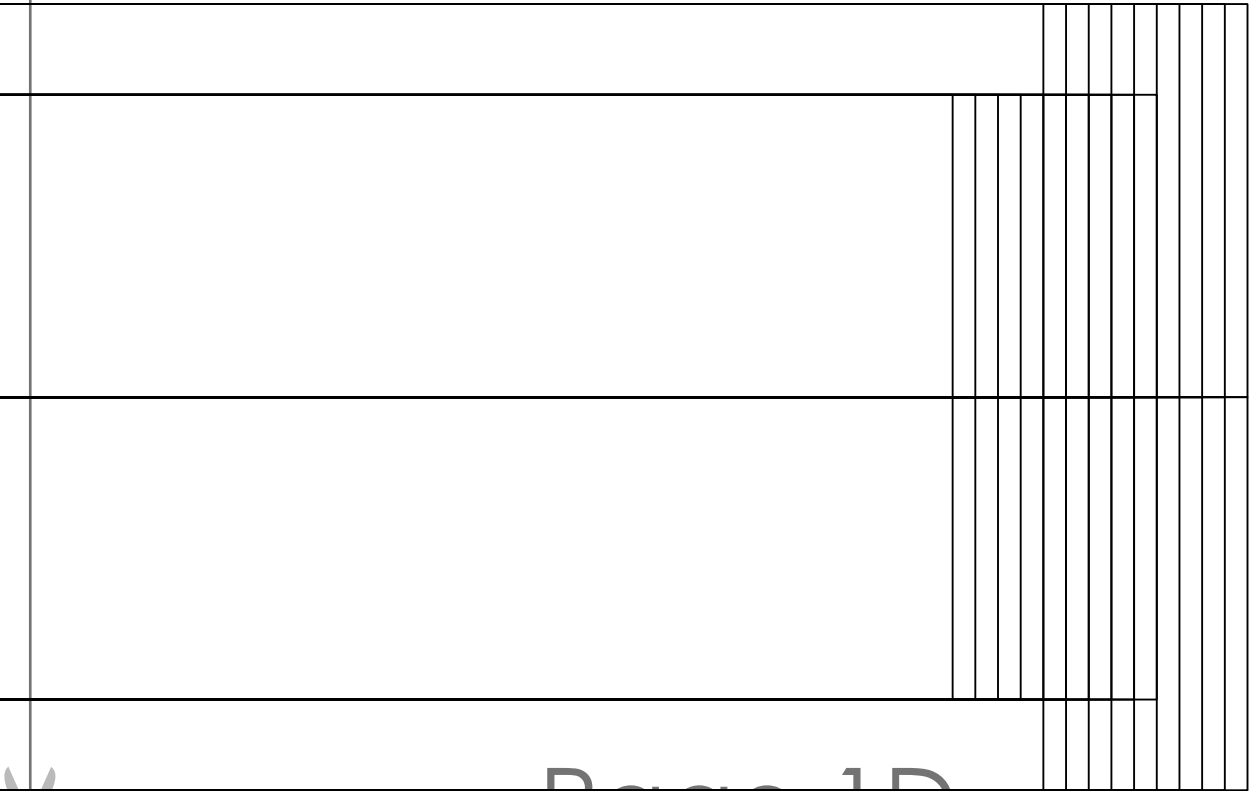

Page 1D



**JUANITTA SWEETHEART CROP TOP
with seam allowance**

Size: M

**SIDE FRONT
cut 2 self + 2 lining**

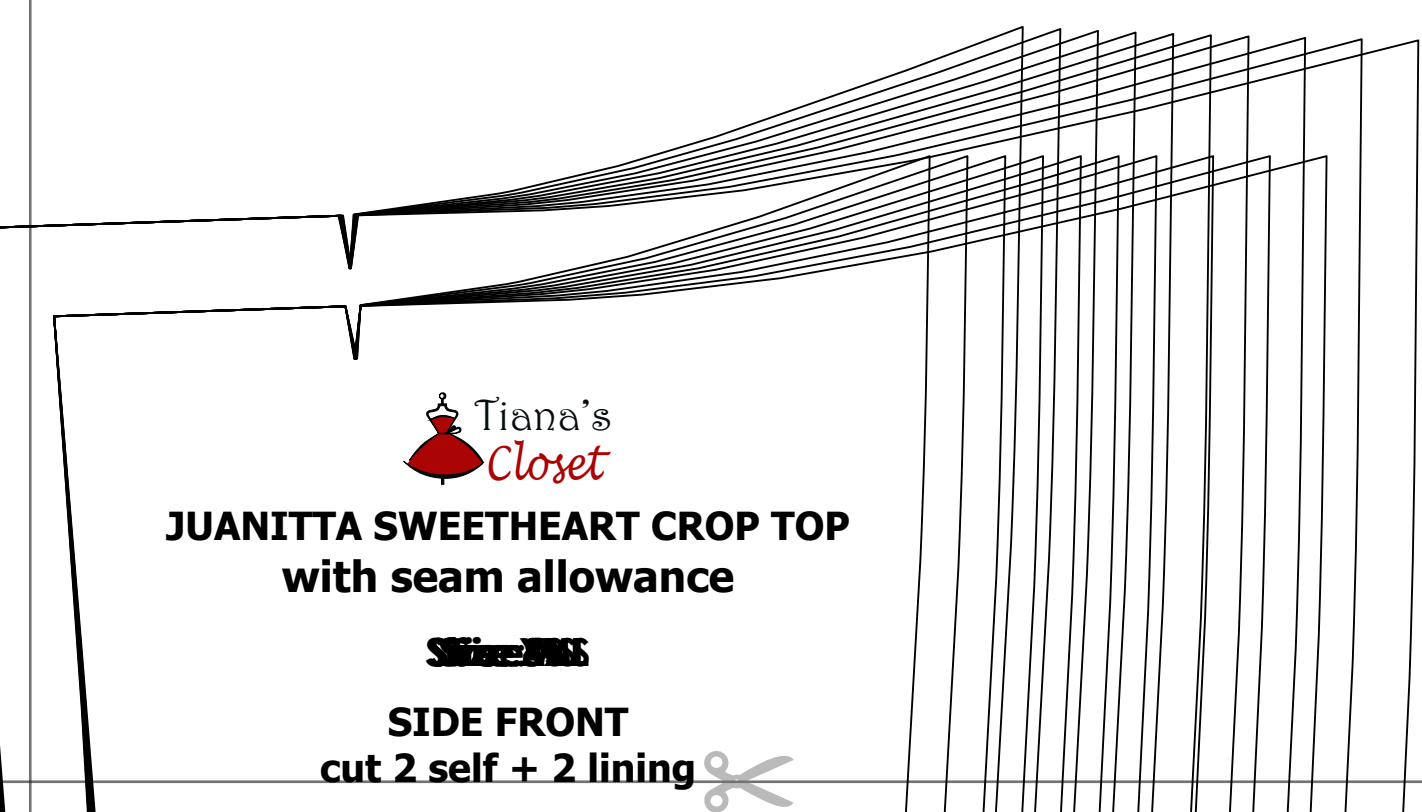



JUANITTA SWEETHEART CROP TOP
with seam allowance

~~SIZE 20-22~~

SIDE FRONT
cut 2 self + 2 lining

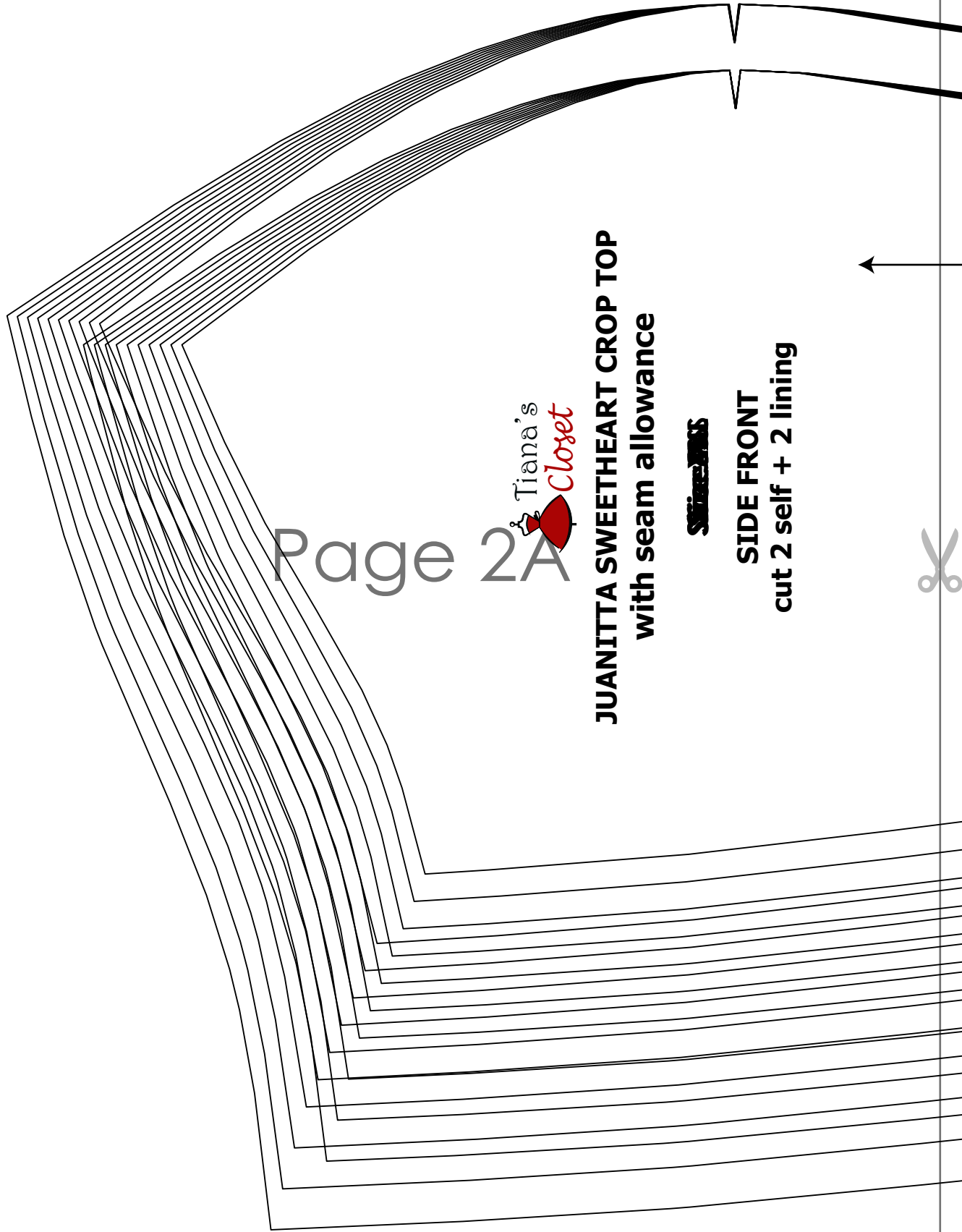

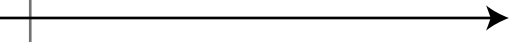

Page 2B

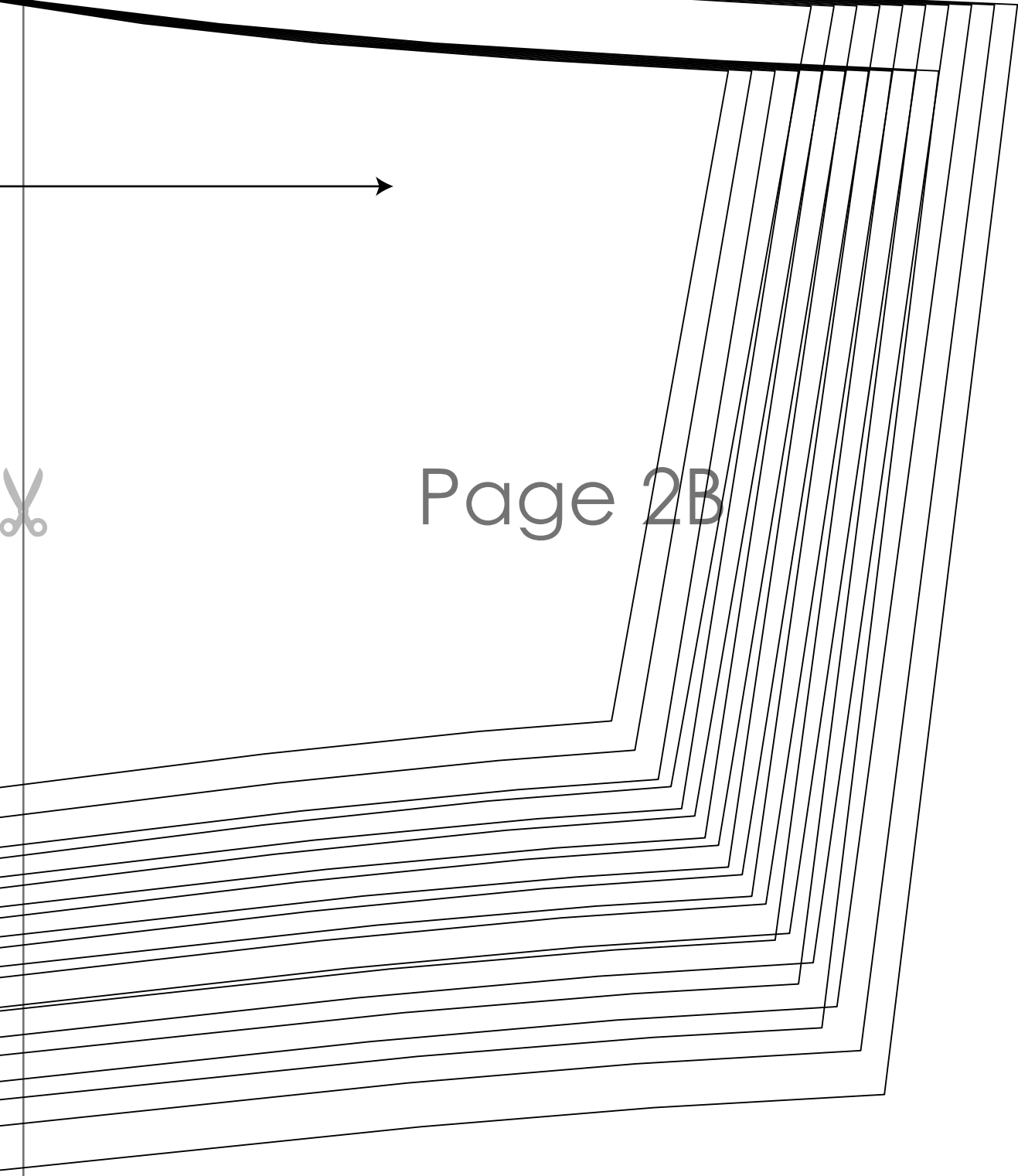

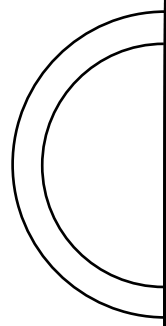

Page 2C

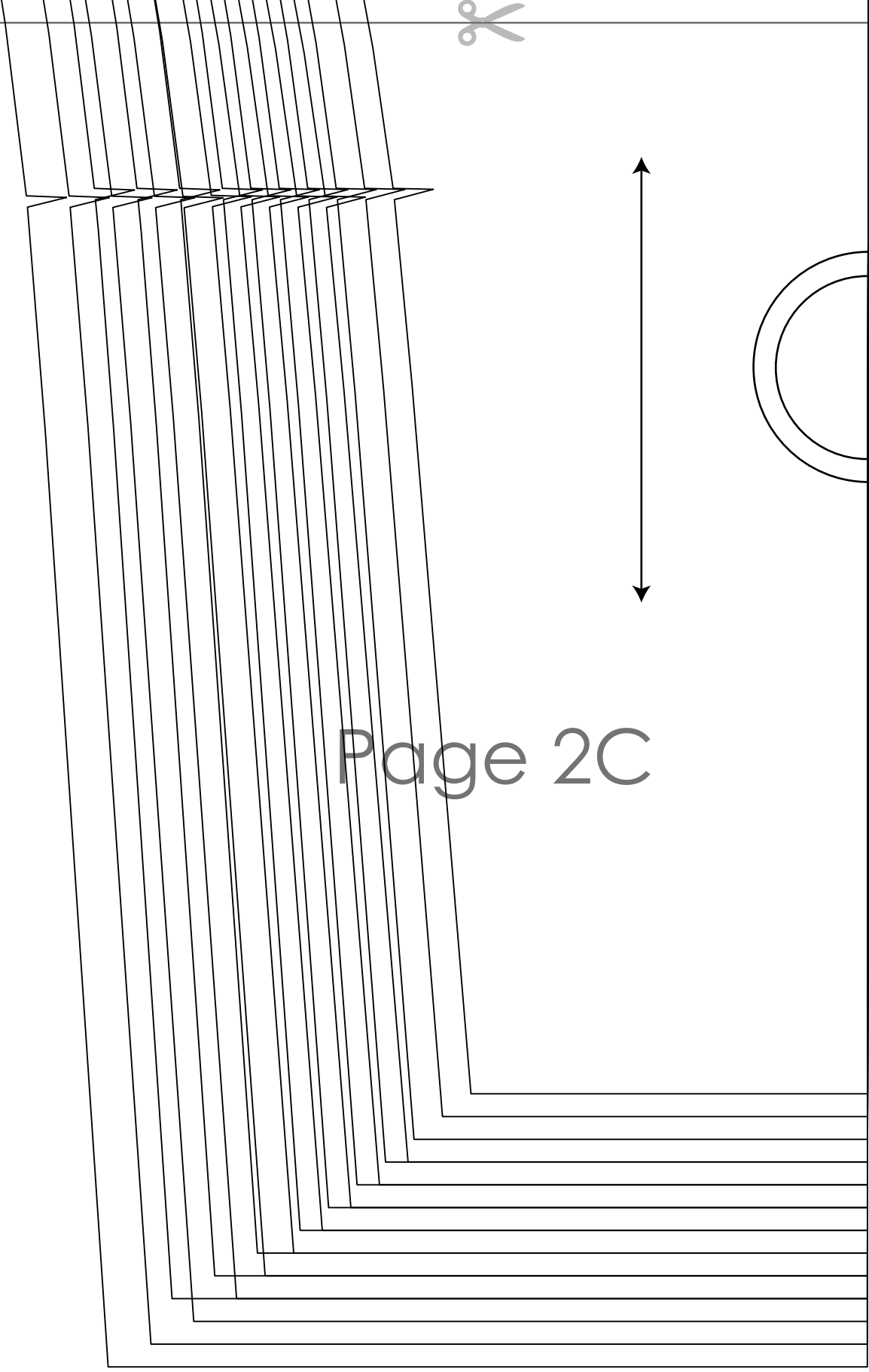

cut 2 self + 2 lining



Page 2D

