

Page 1A

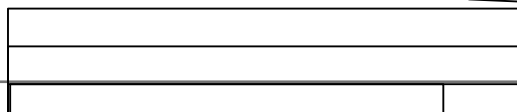



# Page 1B



Tiana's  
*Closet*

## **KID'S JOGGER PANTS with seam allowance**

**SIZE 10**

**FRONT  
cut 2**

For more ideas and free sewing patterns, visit <http://tianscloset.com>



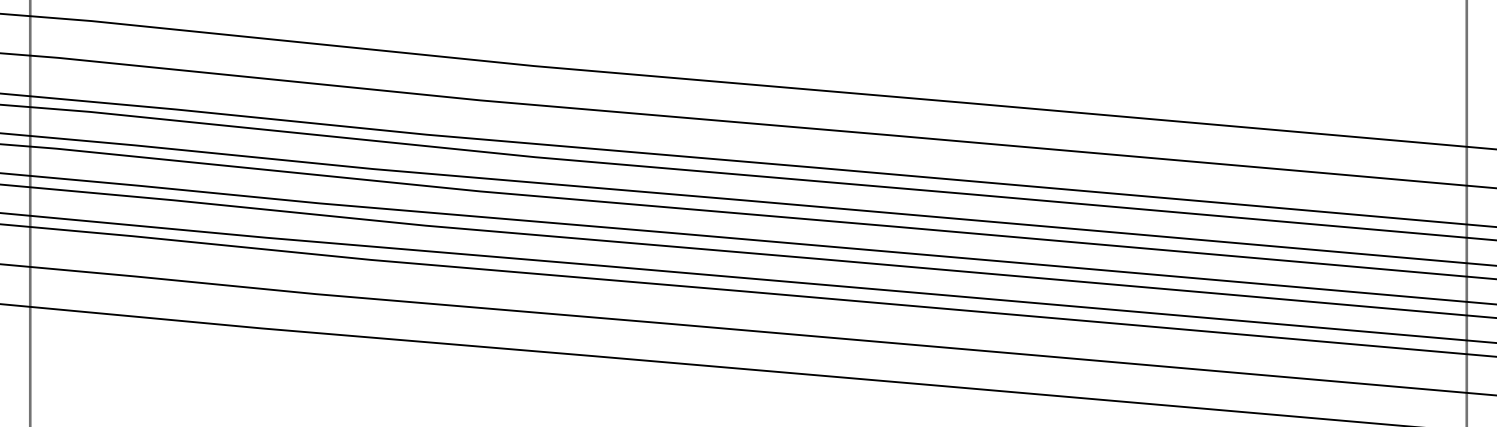

Page 1C

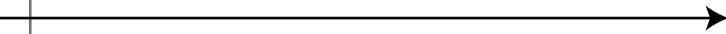

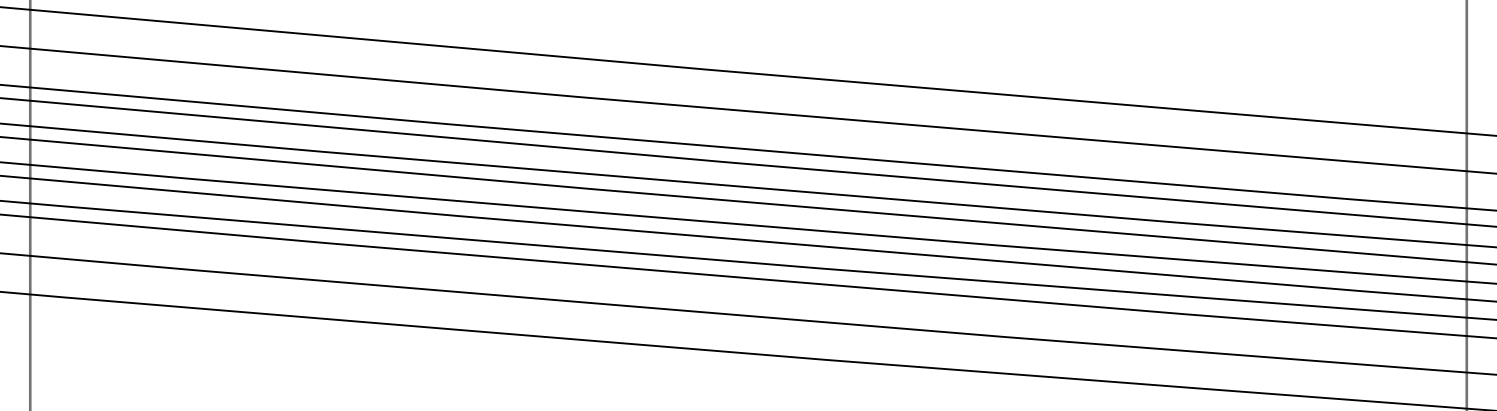

Page 1D

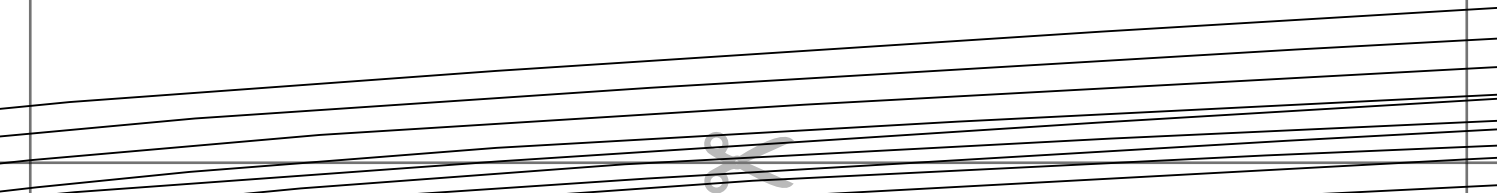

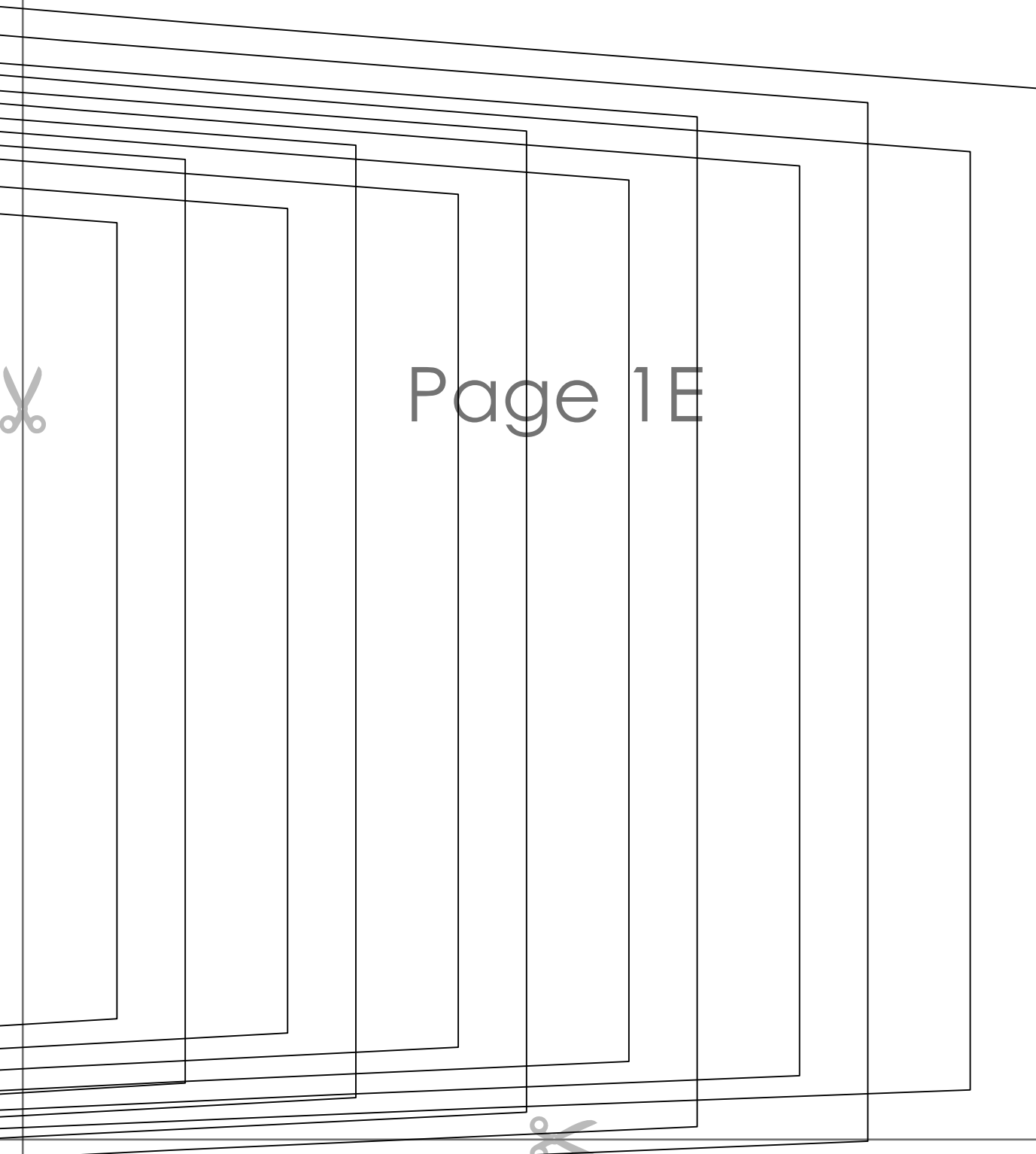

Page 1E





**KID'S JOGGER PANTS  
with seam allowance**

SIZE 120

**PANT CUFF**  
cut 2 on fold

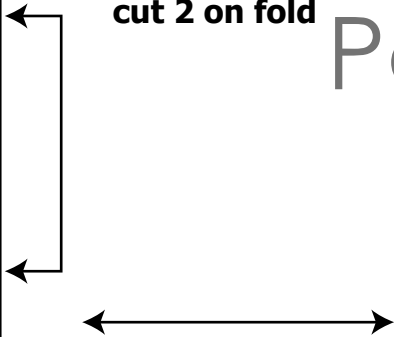

Page 2A



**KID'S JOGGER PANTS  
with seam allowance**

SIZE 120

**POCKET PIECE**  
cut 2

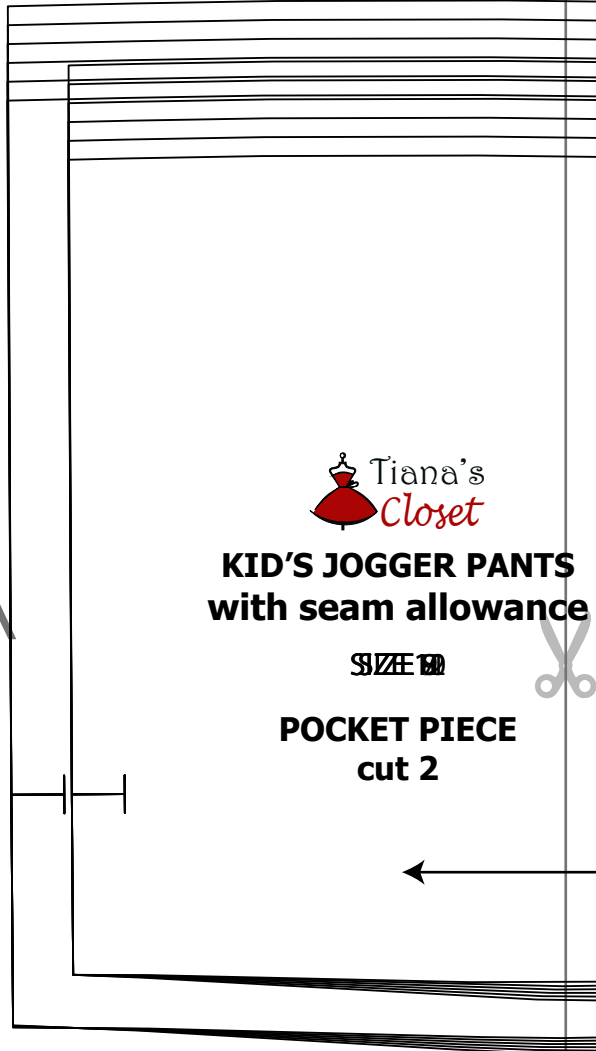

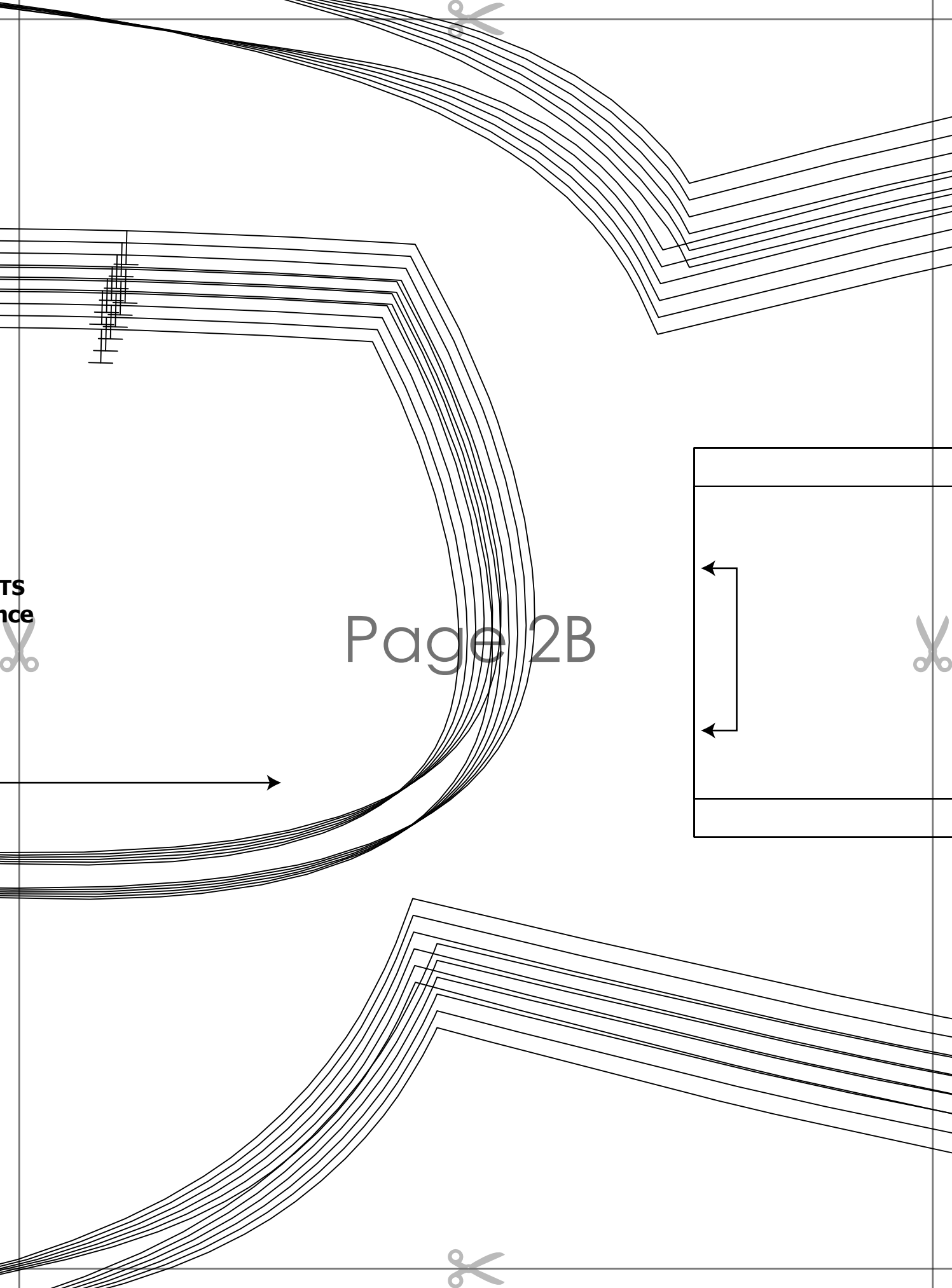

Page 2B

TS  
nce



# Page 2C



**KID'S JOGGER PANTS  
with seam allowance**

**SIZE 10**

**WAISTBAND  
cut 1 on fold**







Page 2E



**KID'S JOGGER PANTS  
with seam allowance**

**SIZE 10**

**POCKET LINING  
cut 2**

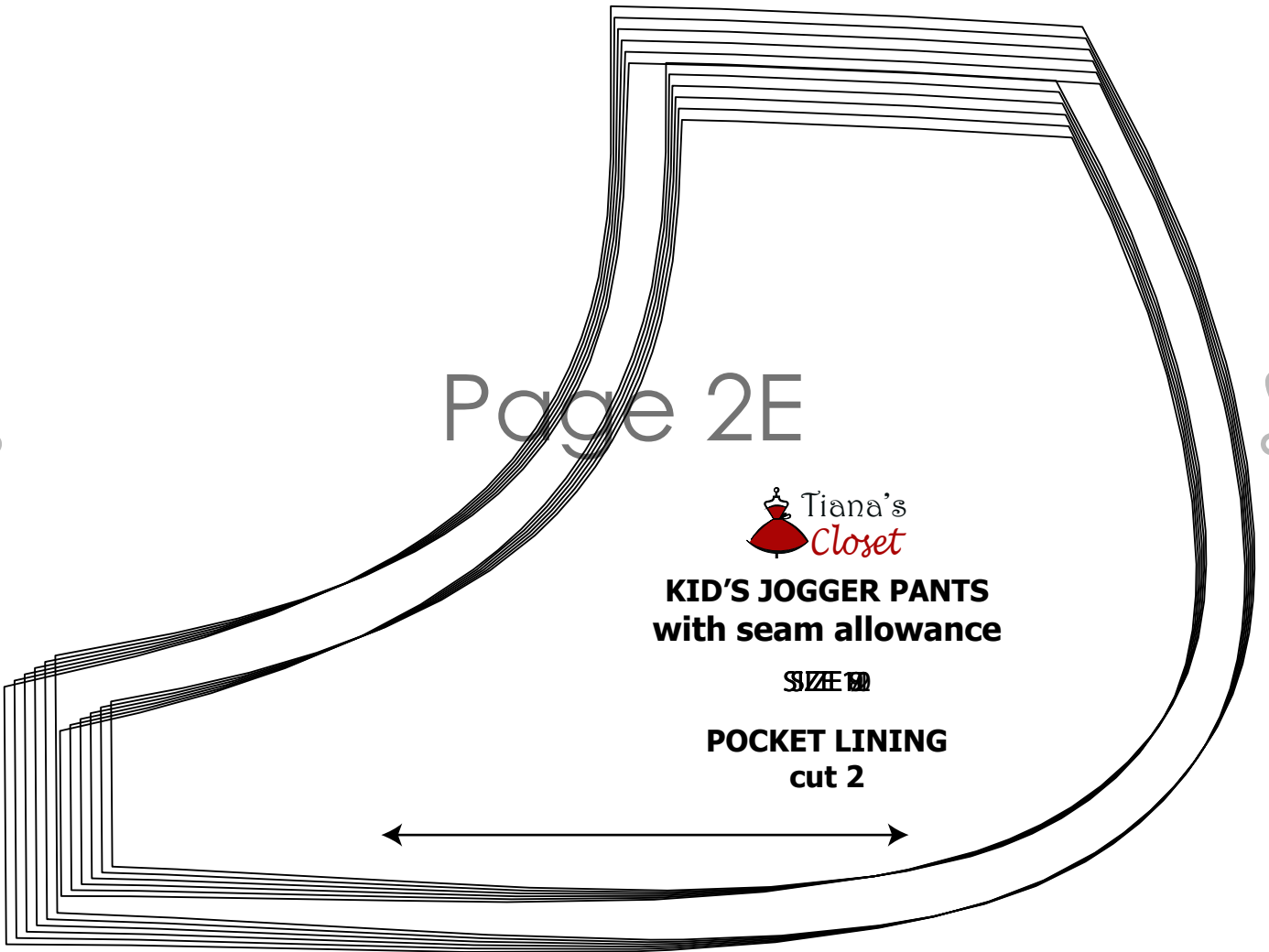
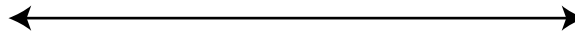

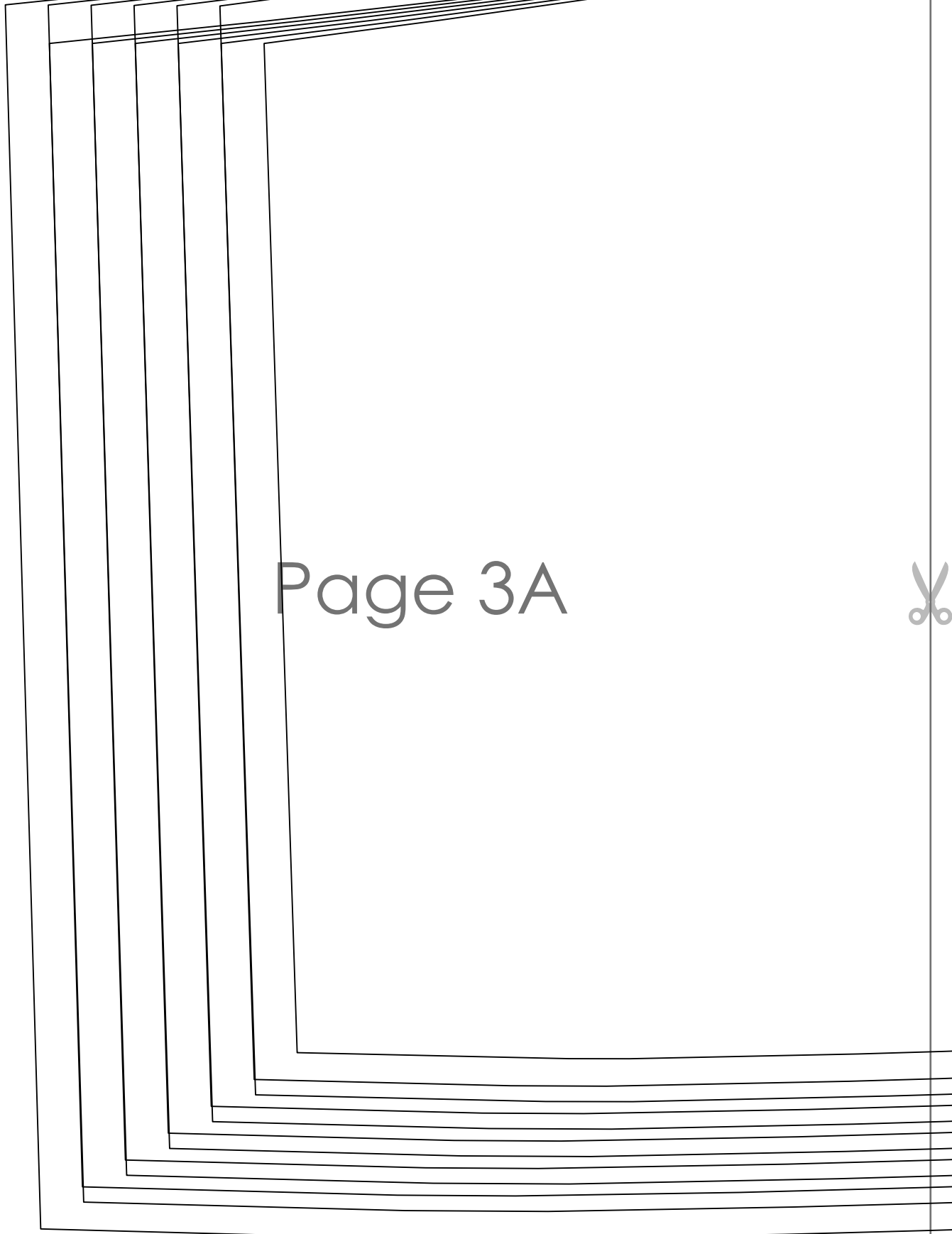
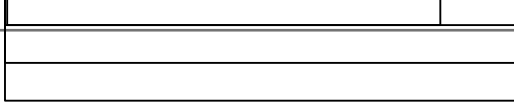

Page 3A





**KID'S JOGGER PANTS  
with seam allowance**

**SIZE 10**

**BACK  
cut 2**

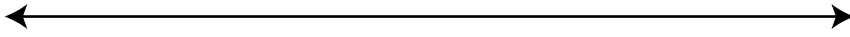

Page 3B



Page 3C

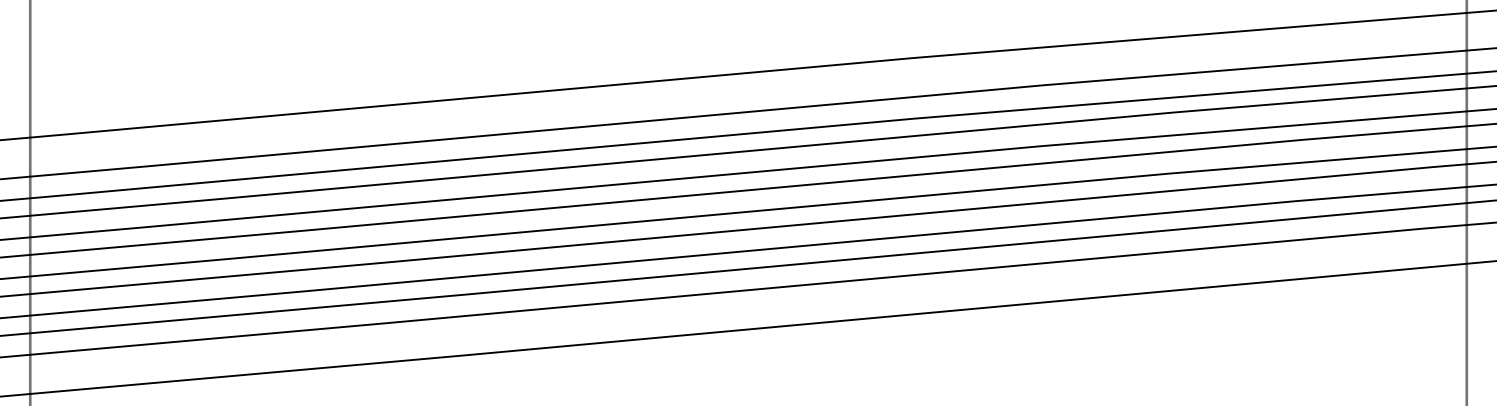



Page 3D





Page 3E

