

Page 1A

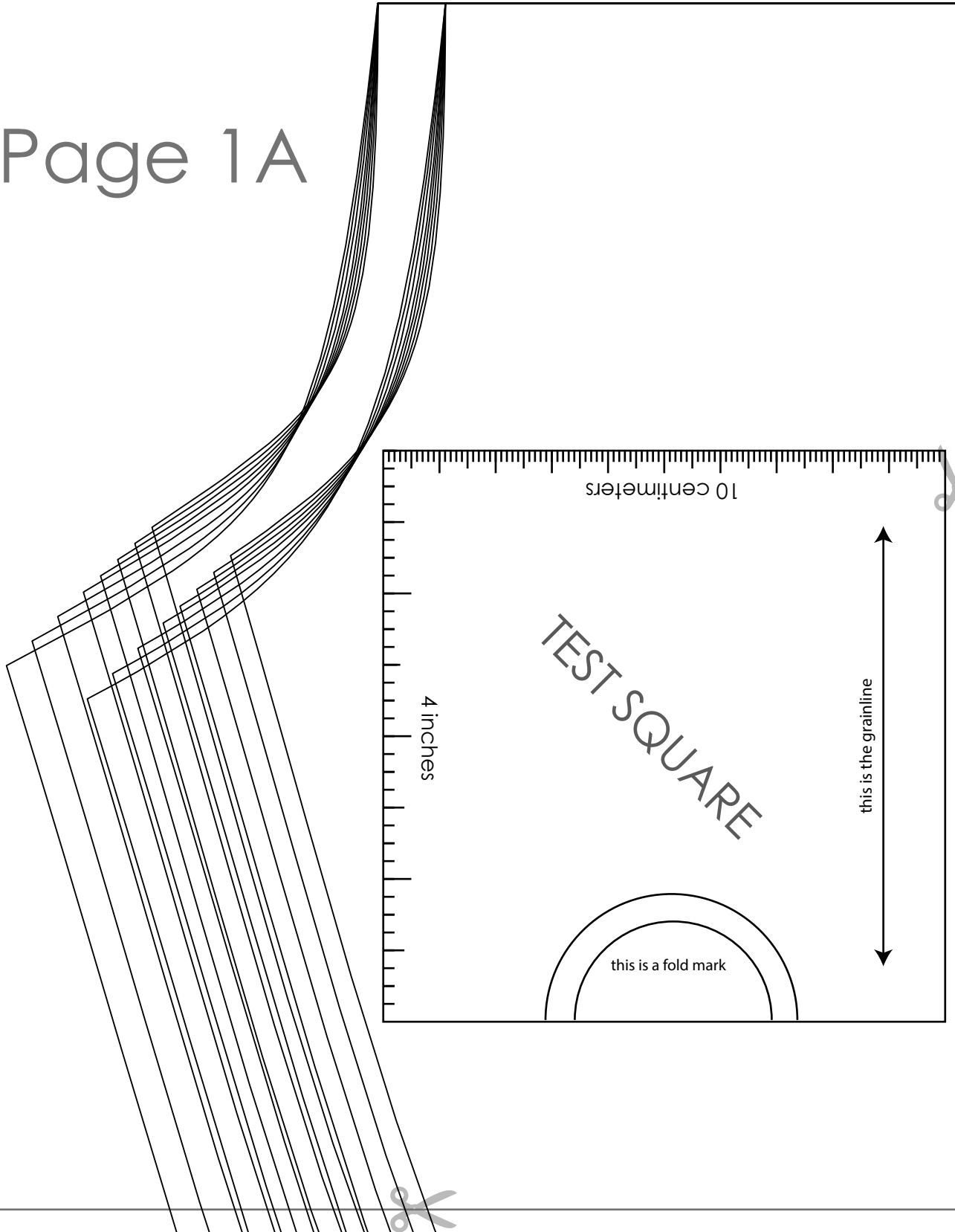



Page 1B



Tiana's
Closet

**MEN'S V NECK T SHIRT
with seam allowance**

~~Size: M~~

**BACK
cut 1 on fold**

For more ideas and free sewing patterns, visit <http://tianscloset.com>



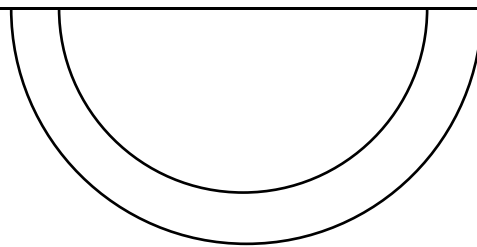

Page 1C

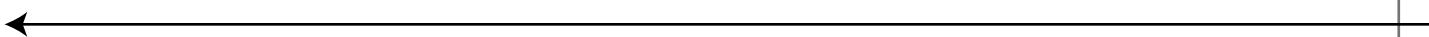



Page 1D

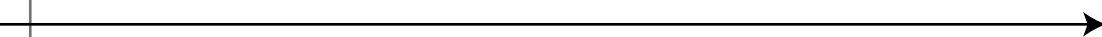



Page 1E

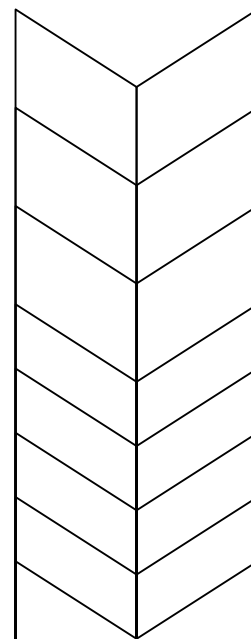

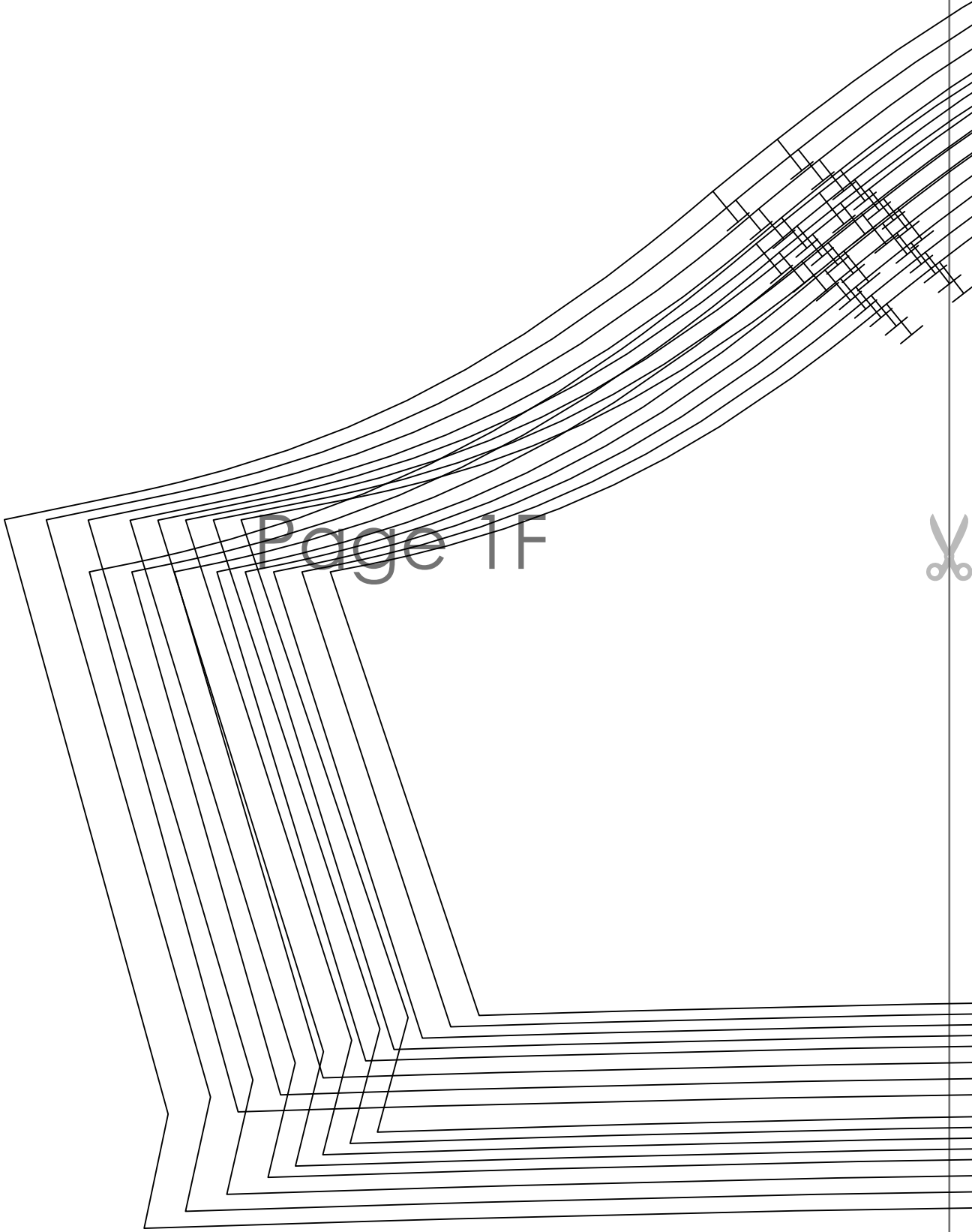

Page 1F



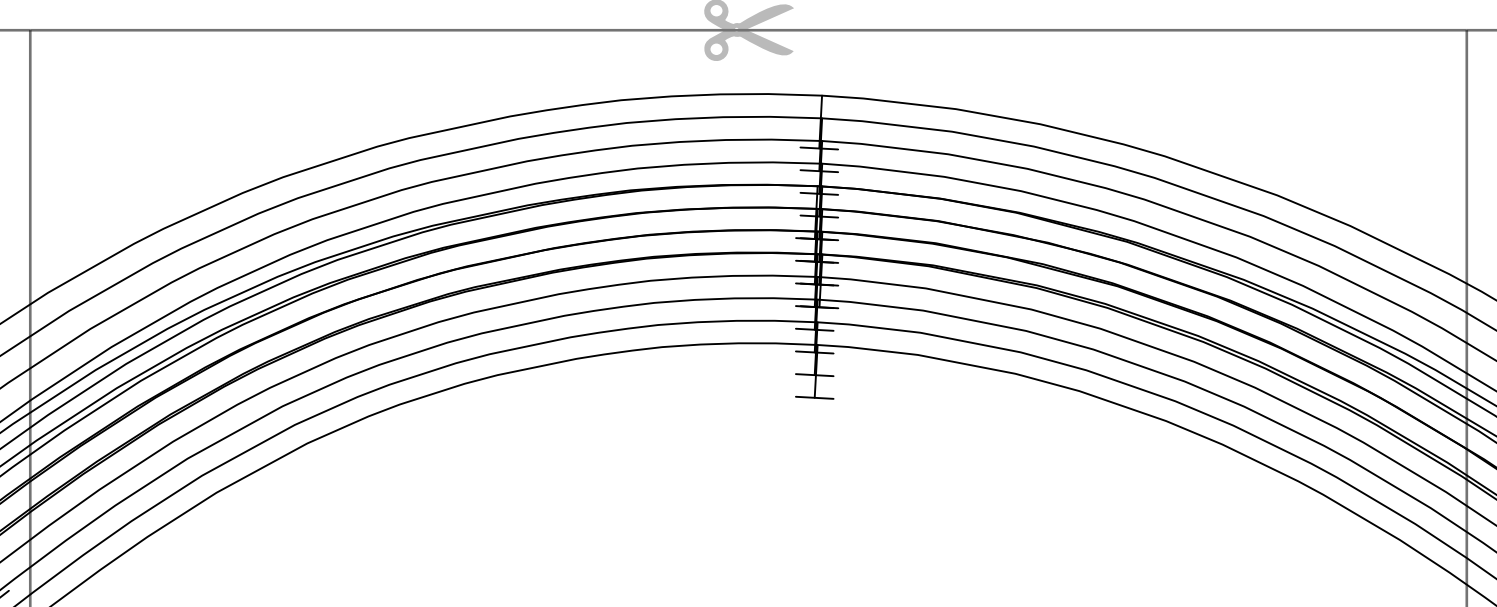

Page 1G



**MEN'S V NECK T SHIRT
with seam allowance**

~~Size M~~

**SLEEVE
cut 2**

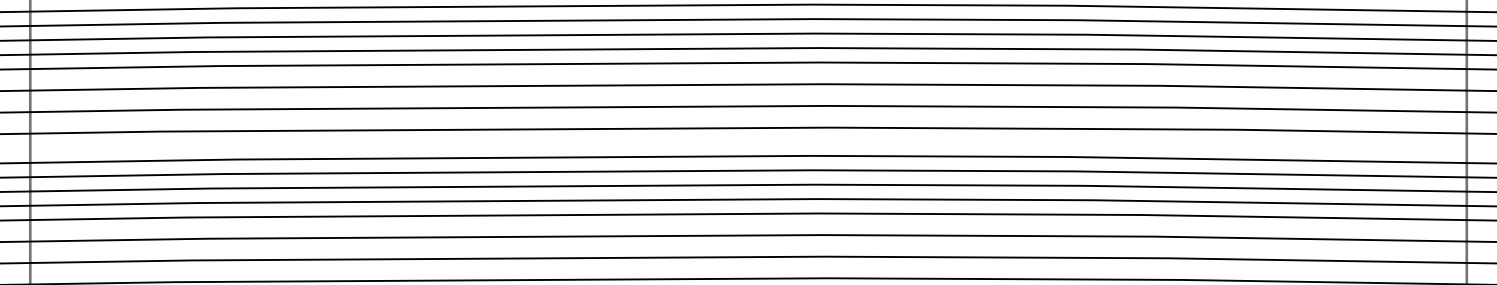

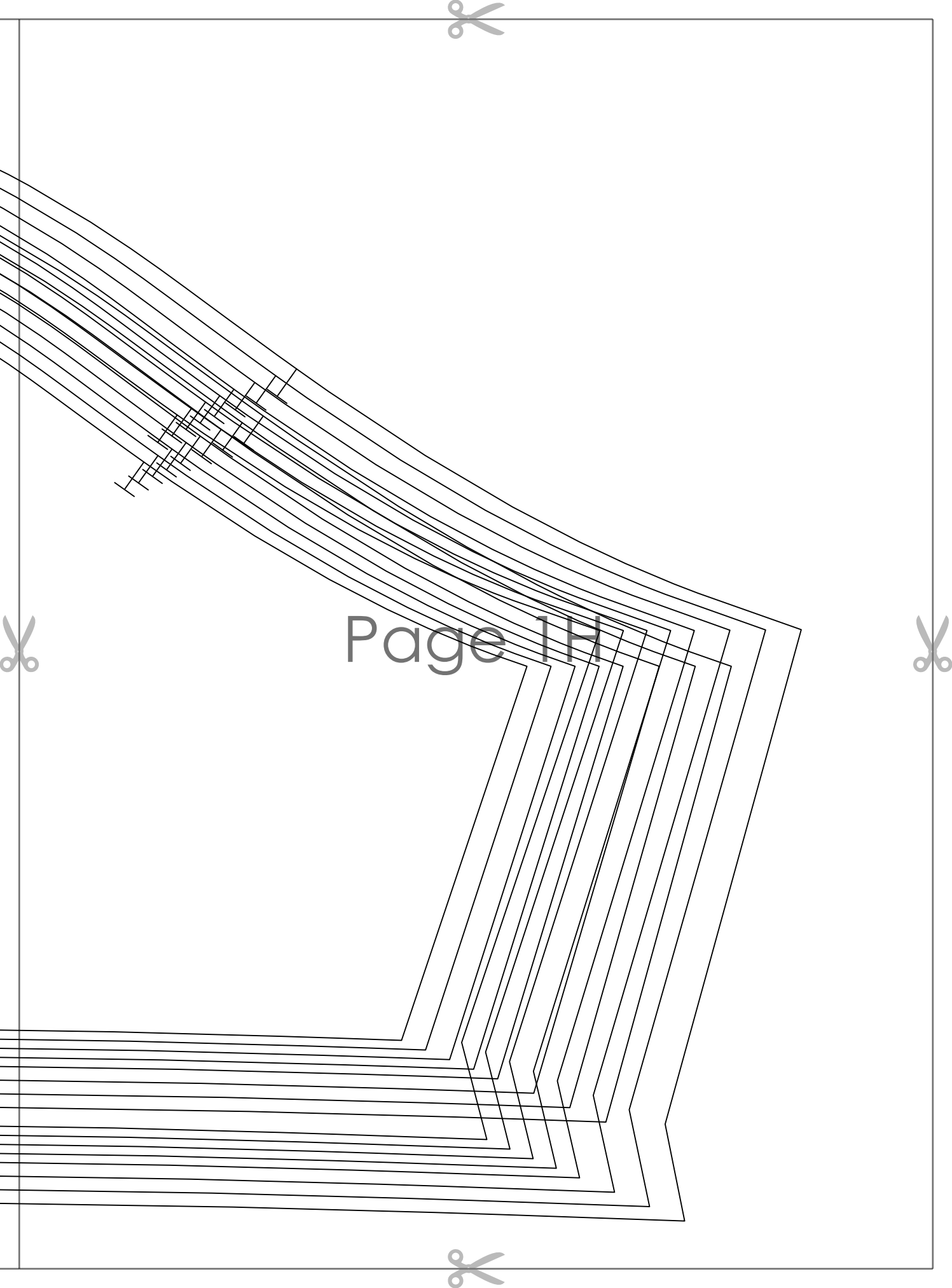

Page 1H

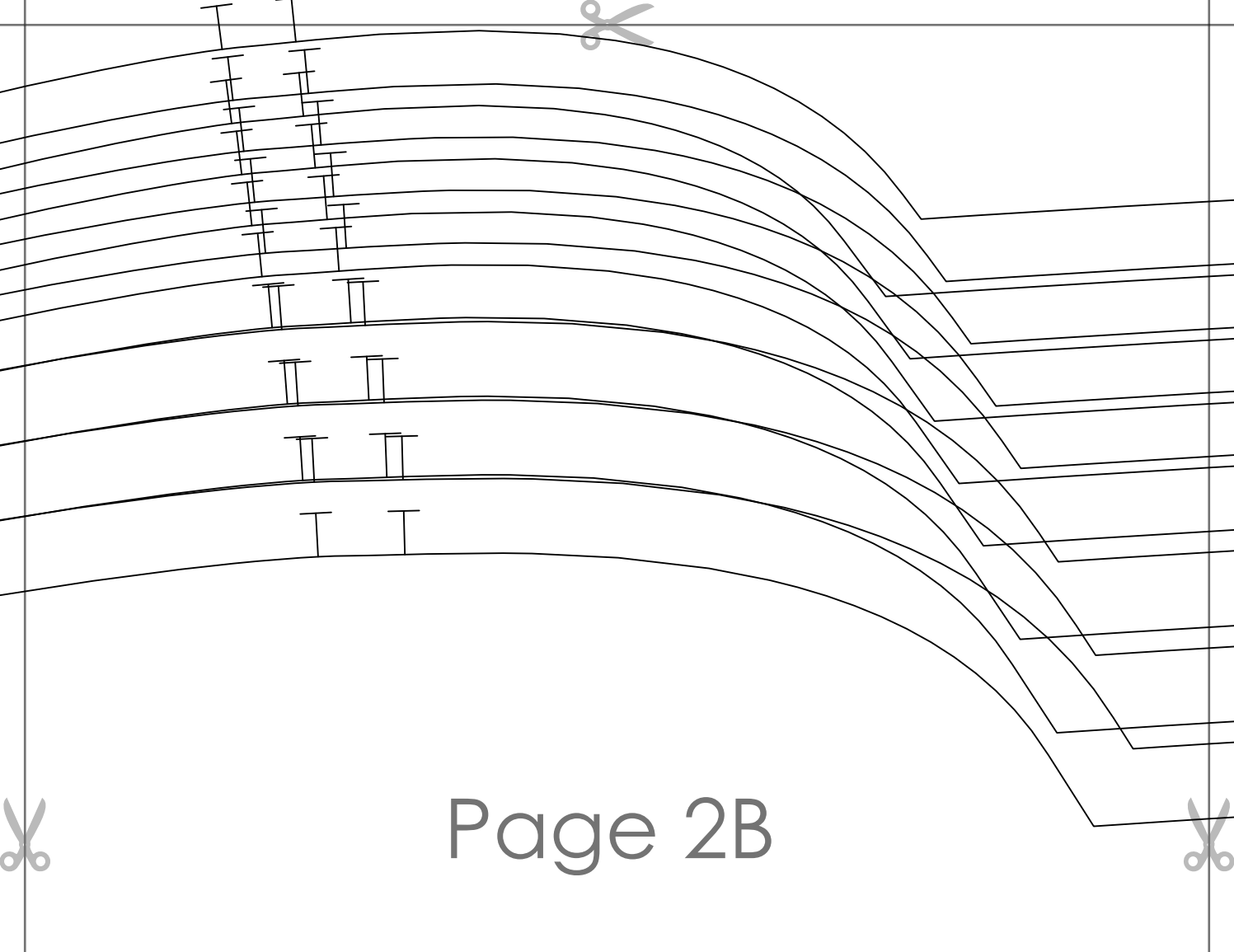

Page 2B





Page 2C

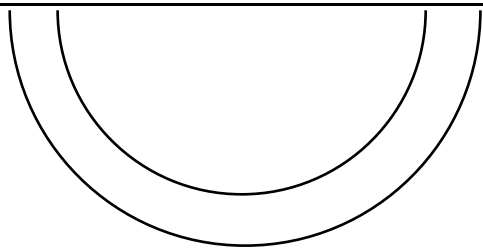



Page 2D

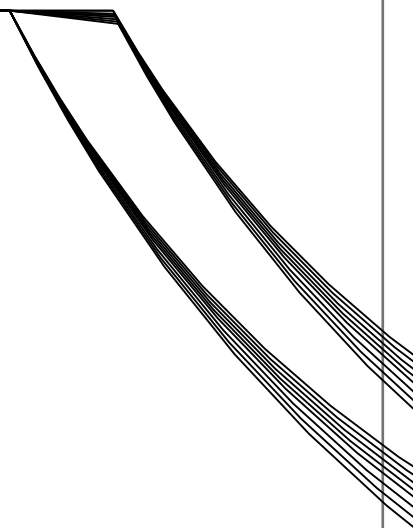
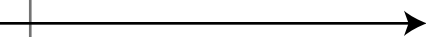

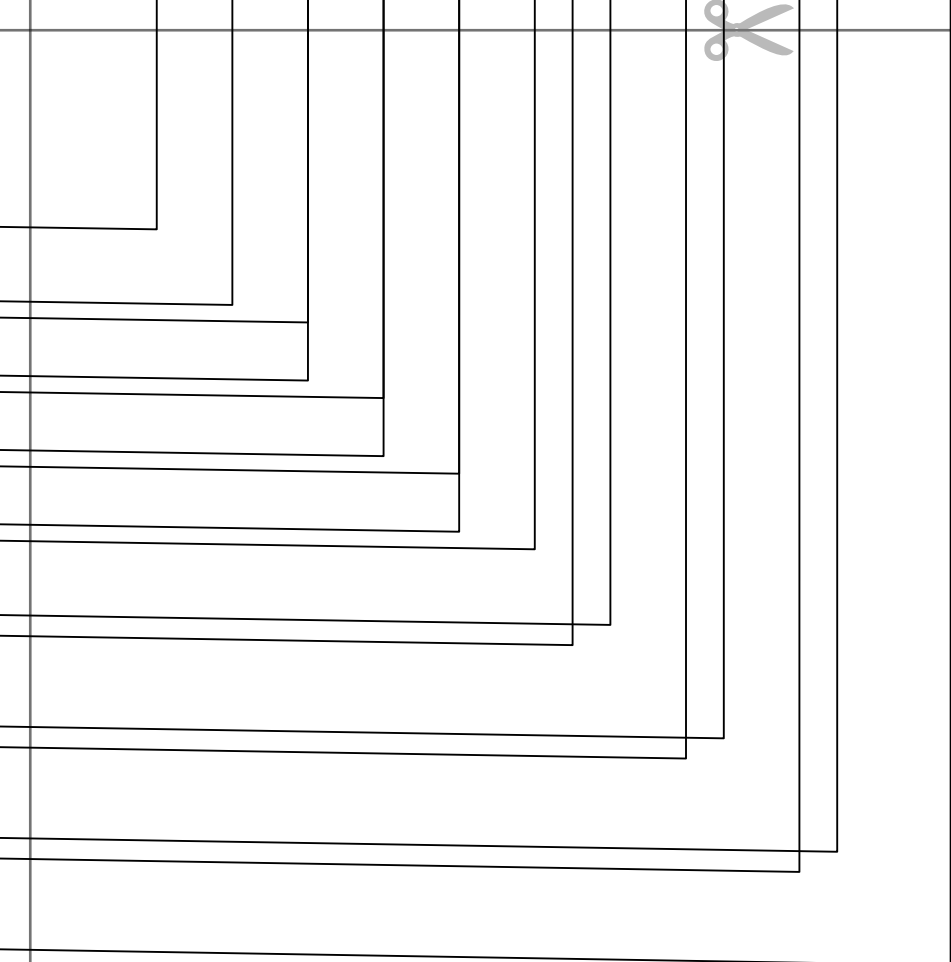

Page 2E



MEN'S V NECK T SHIRT
with seam allowance

Small

NECKLINE BINDING
cut 1

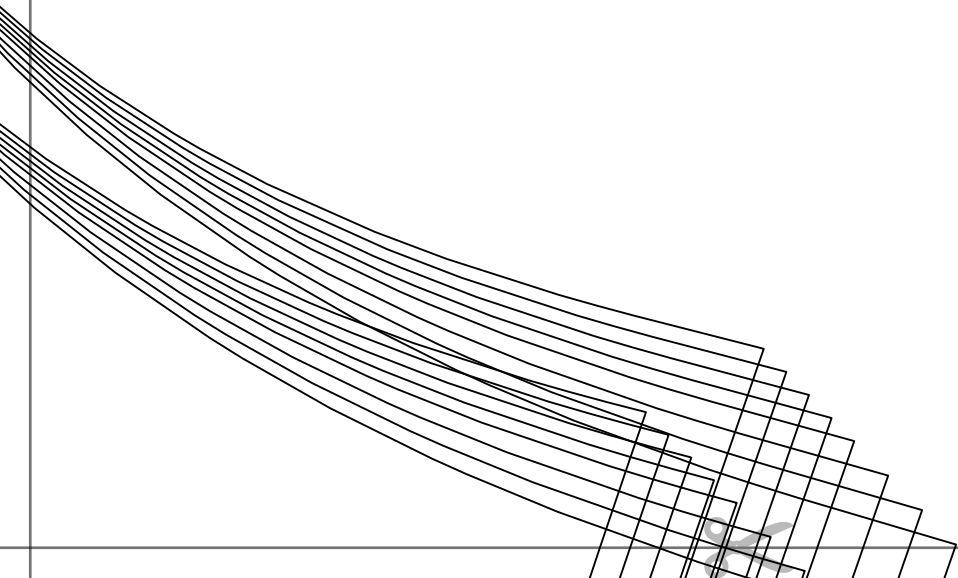

Page 3A





Page 3B





**MEN'S V NECK T SHIRT
with seam allowance**

Size: M

**FRONT
cut 1 on fold**

Page 3C





Page 3D





Page 3E

