

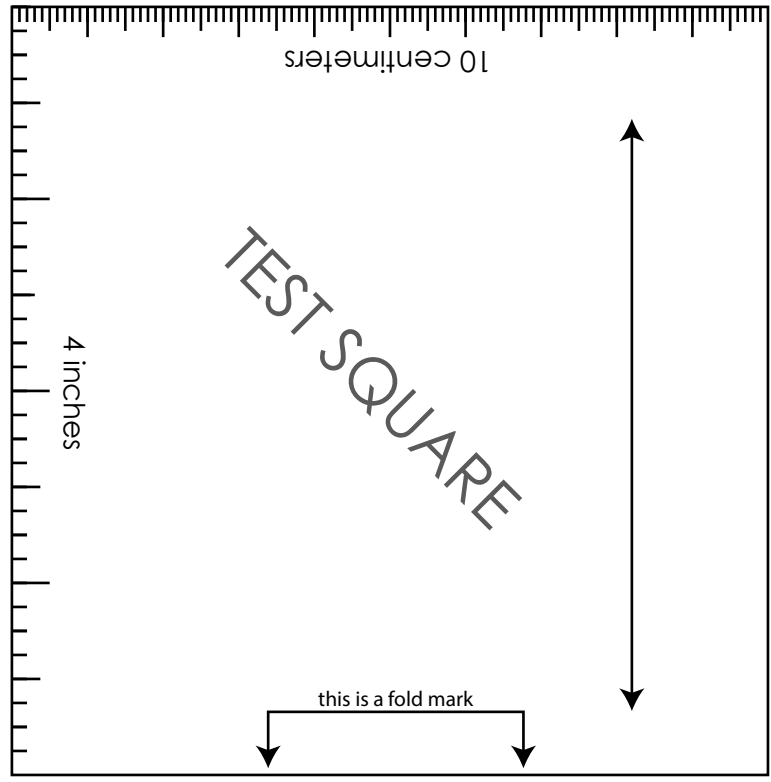

# Page 1A

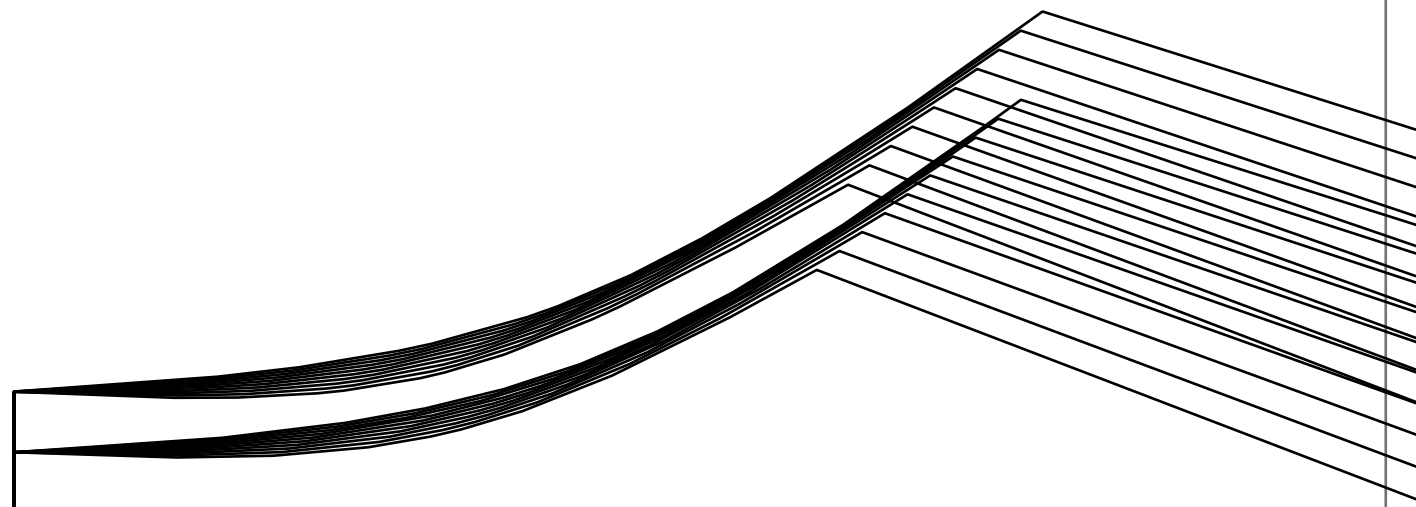

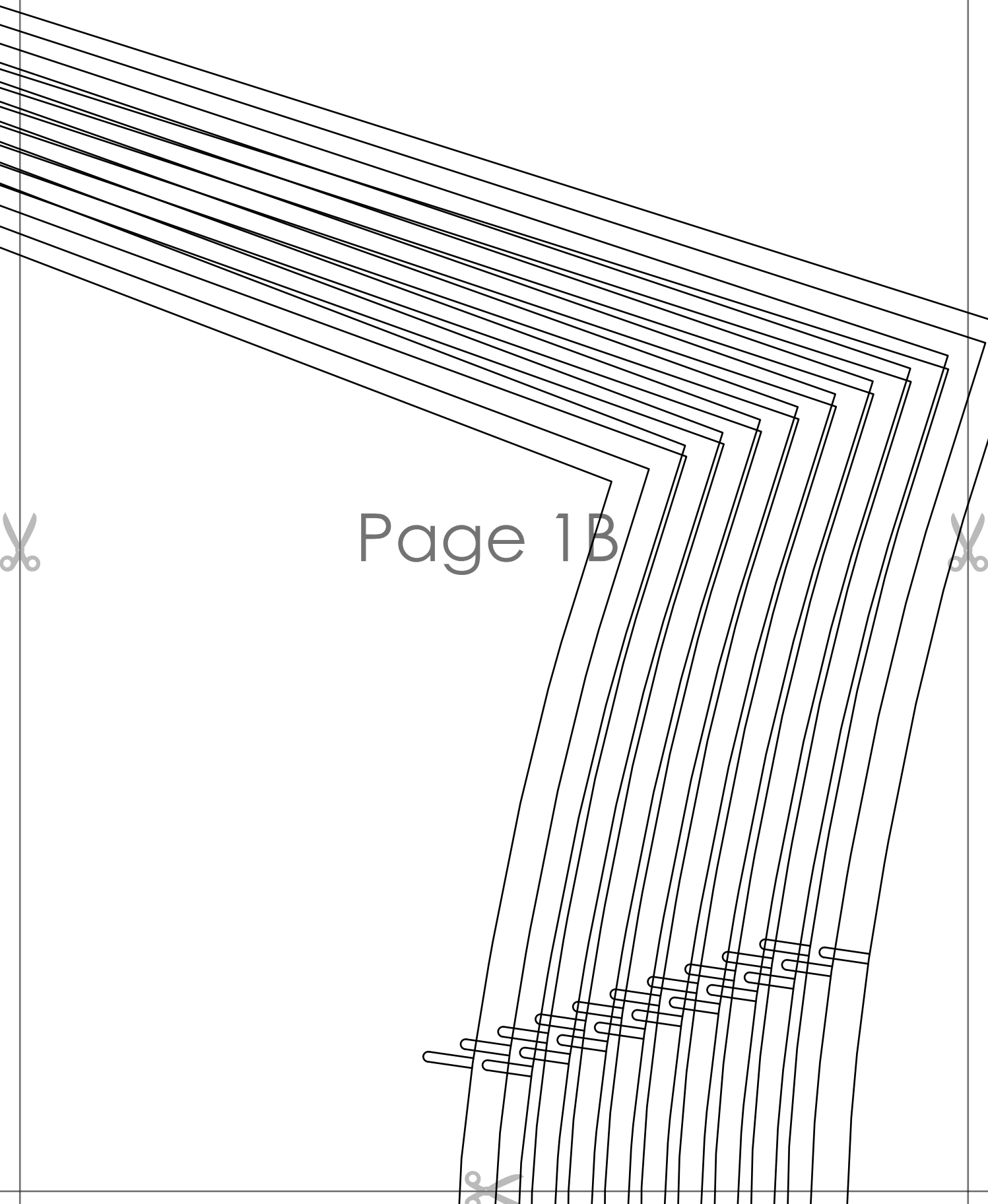

Page 1B





Page 1C





Page 1D



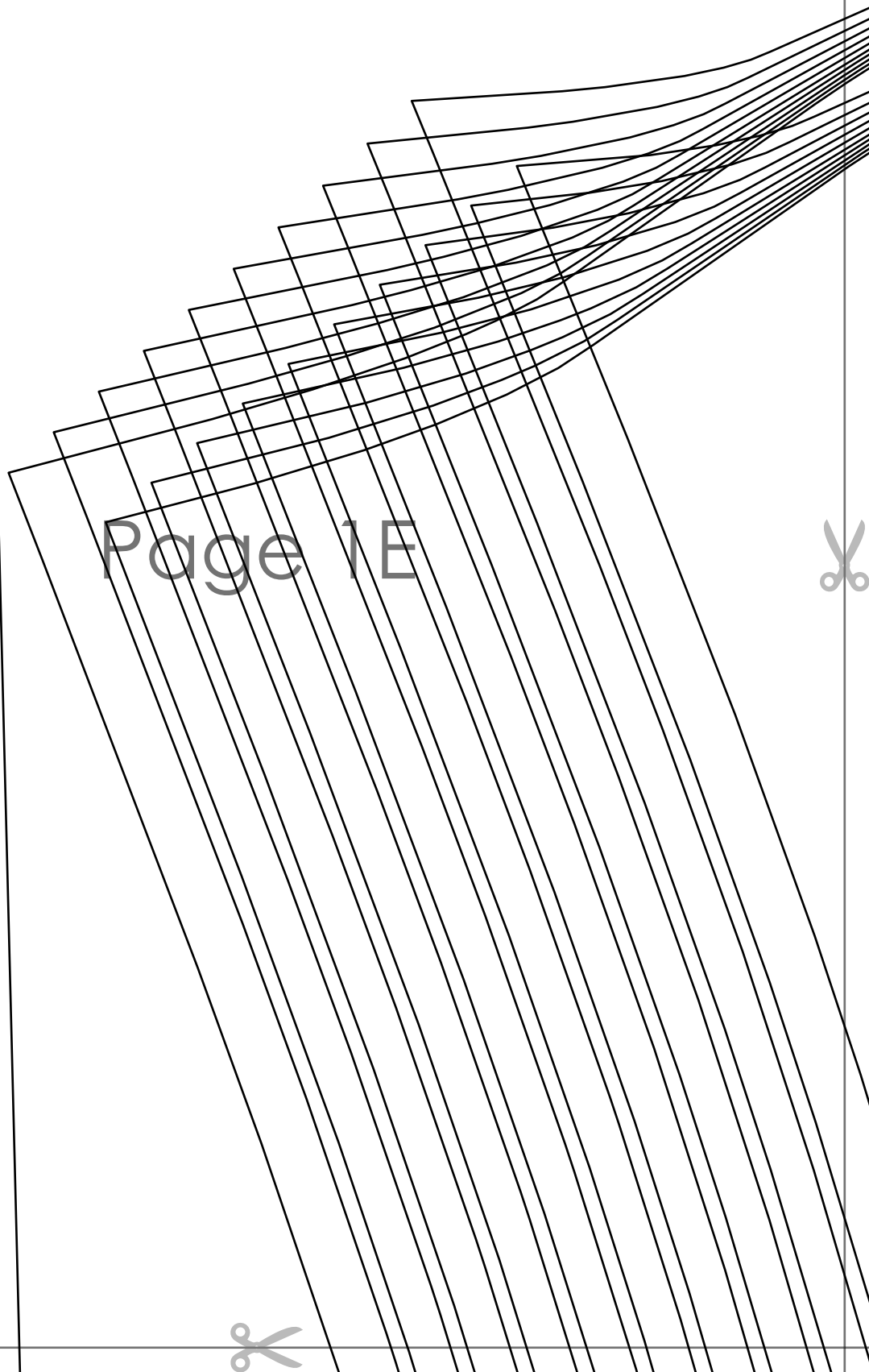
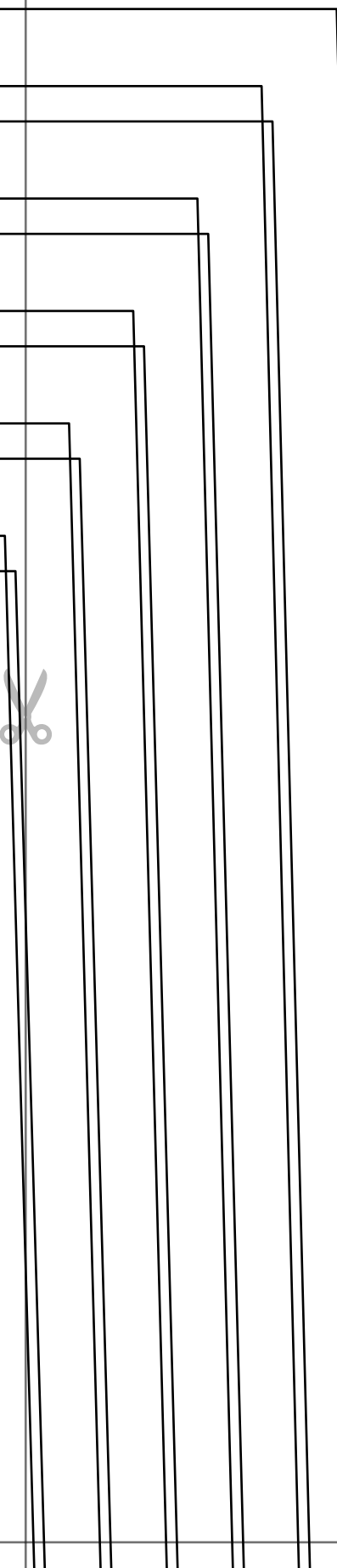

Page 1E



Page 1F



**MEN'S TURTLE NECK SWEATSHIRT  
with seam allowance**

**Size: M**

**SLEEVE  
cut 2**

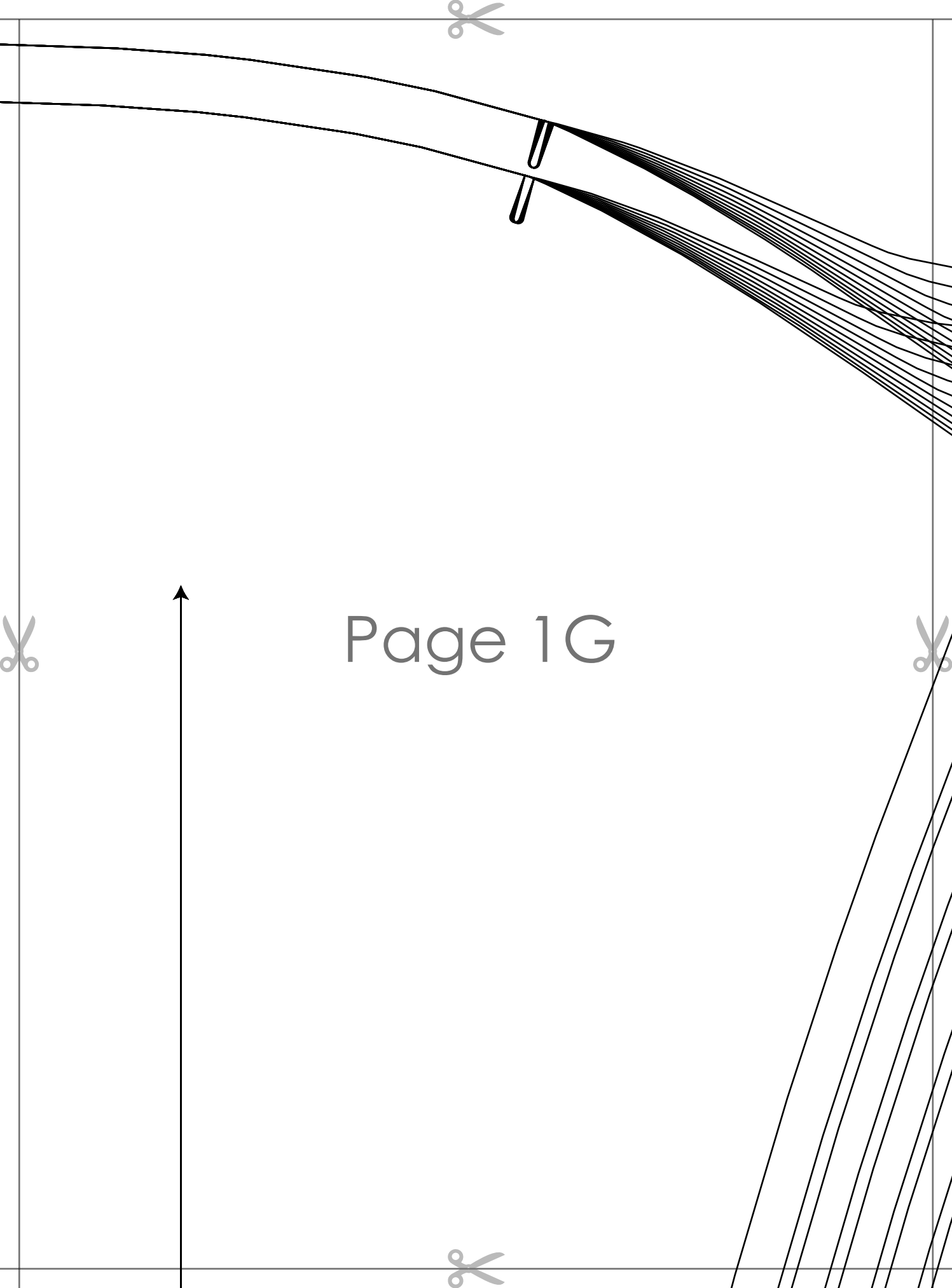

Page 1G

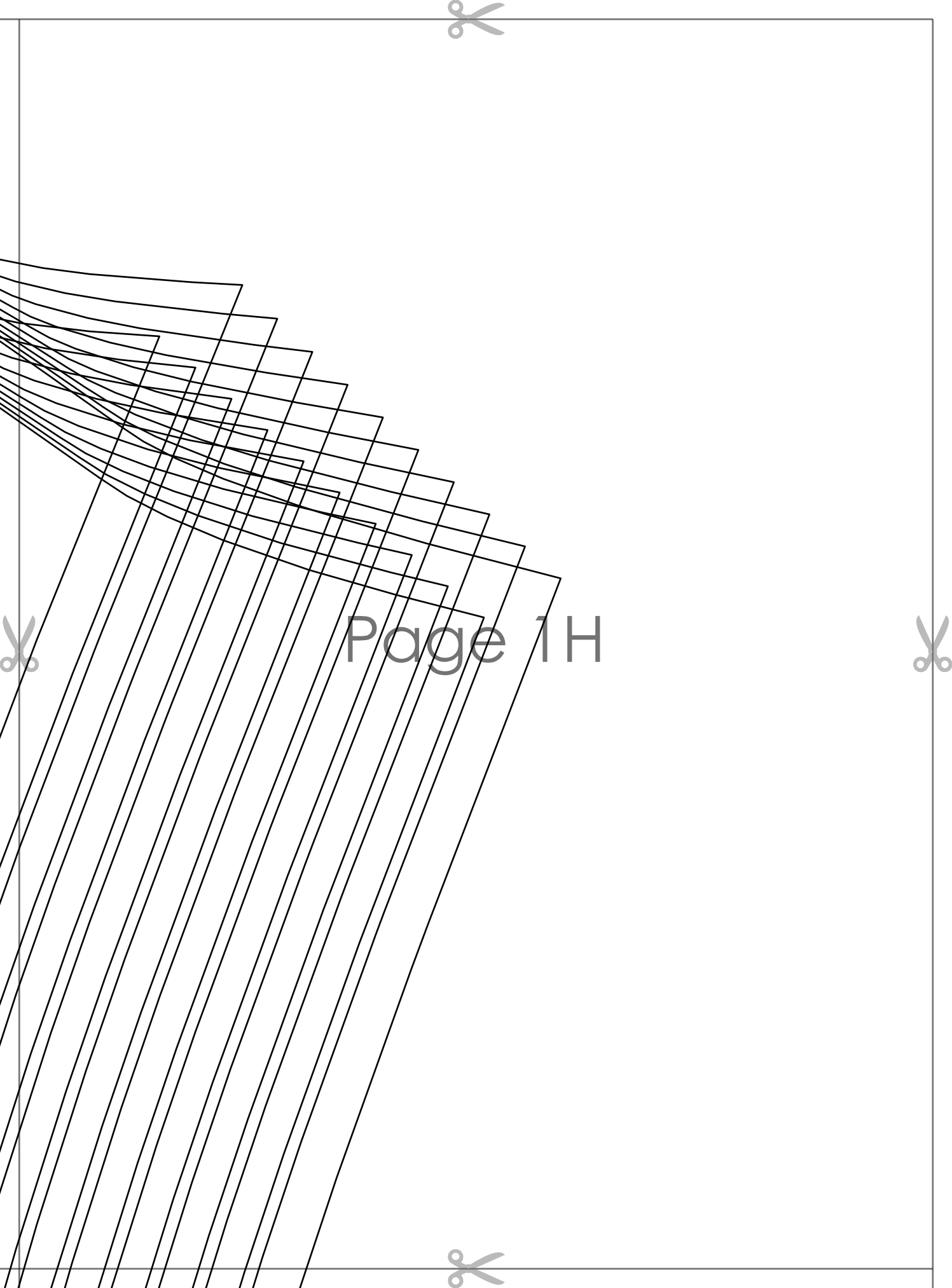

Page 1H





**MEN'S TURTLE NECK SWEATSHIRT  
with seam allowance**

**~~Size: M~~**

**BACK  
cut 1 on fold**

Page 2A

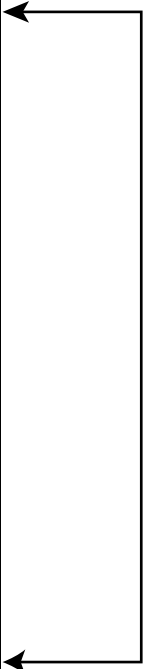

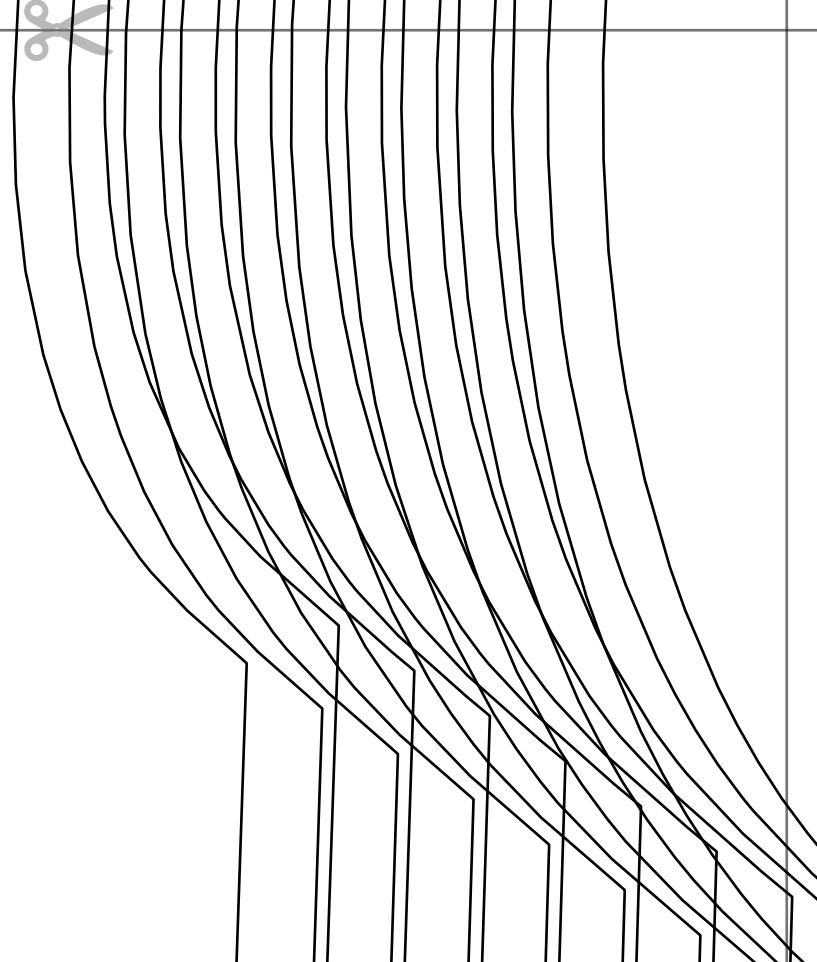

Page 2B





Page 2C

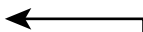



Page 2D

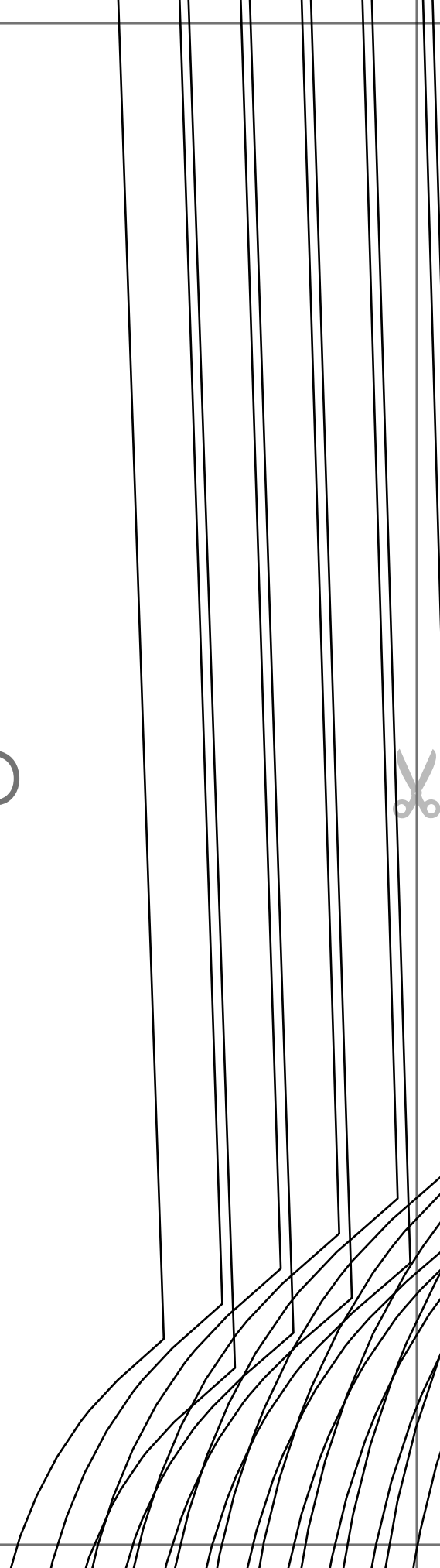



Page 2E







Page 2F

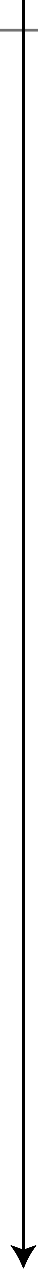

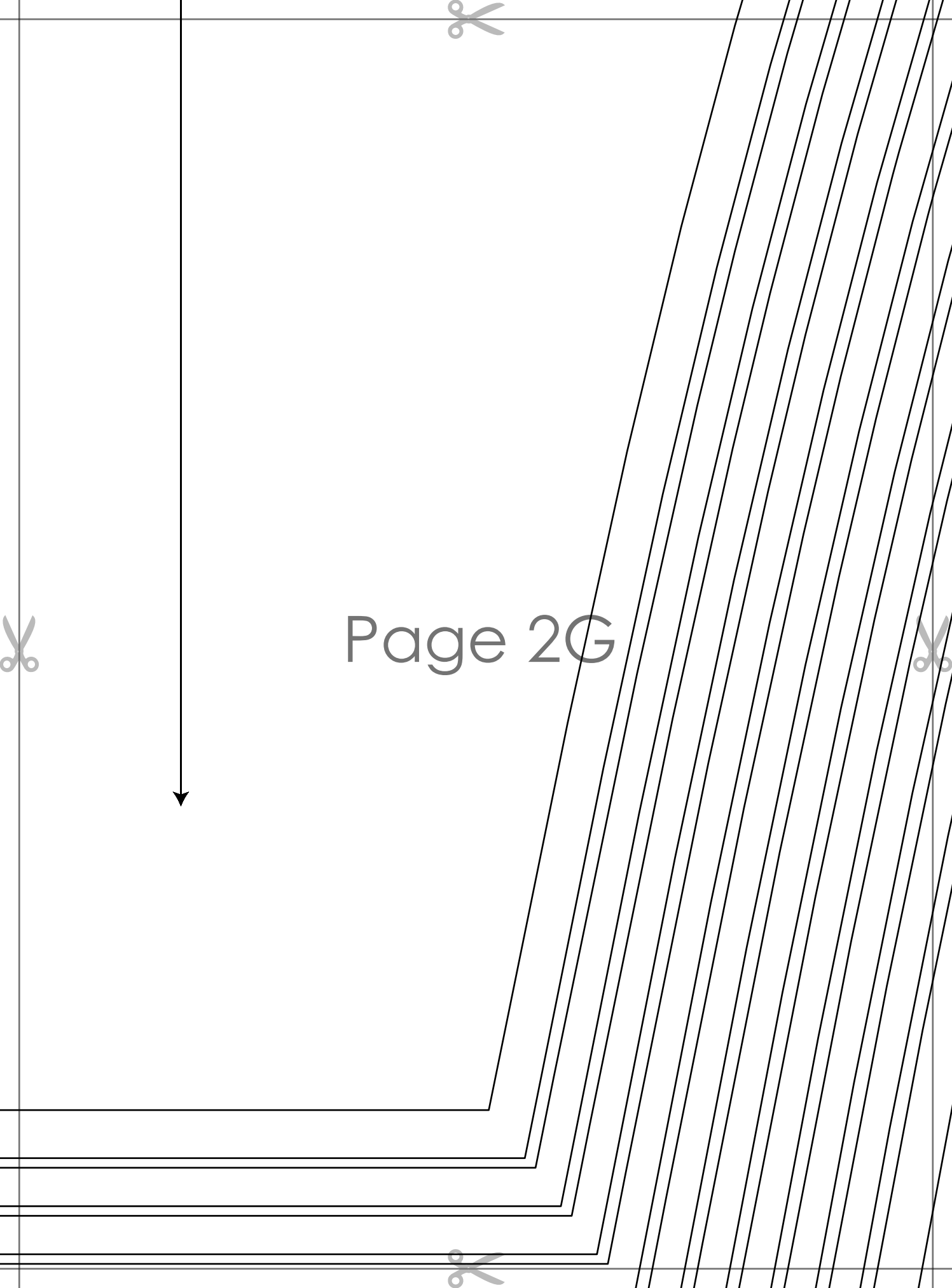

Page 2G

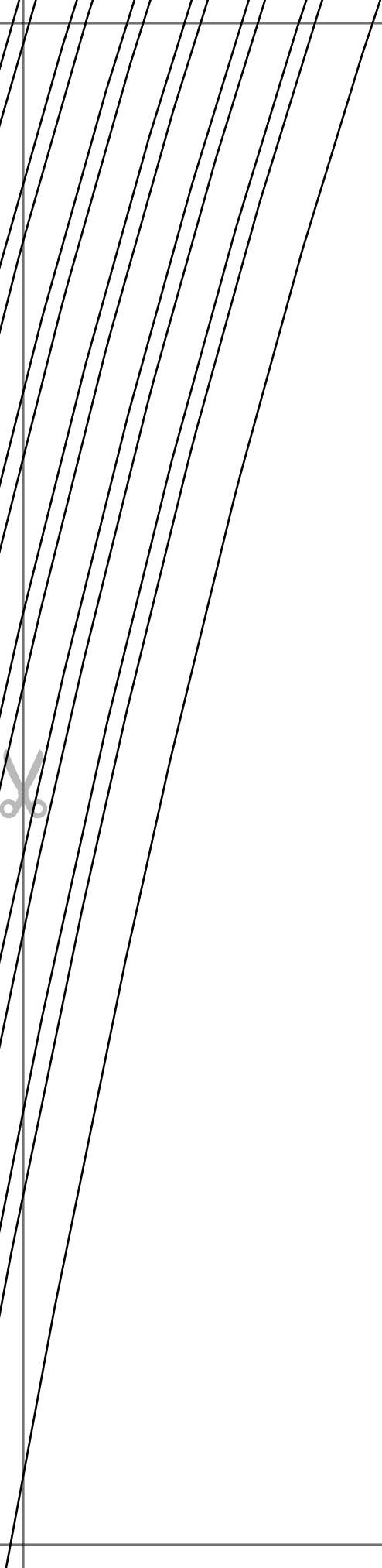



Page 2H







For more ideas and free sewing patterns, visit <http://tianasclouse.com>

Page 3A





et.com

Page 3B



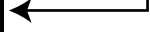

cut 1 on fold

FRONT

~~STEEPS~~

with seam allowance

MEN'S TURTLE NECK SWEATSHIRT



Page 3C

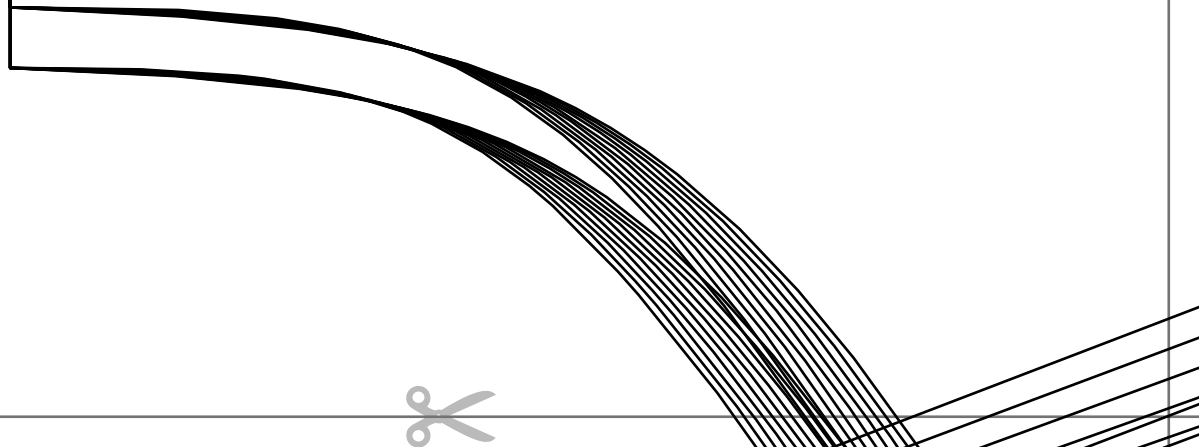

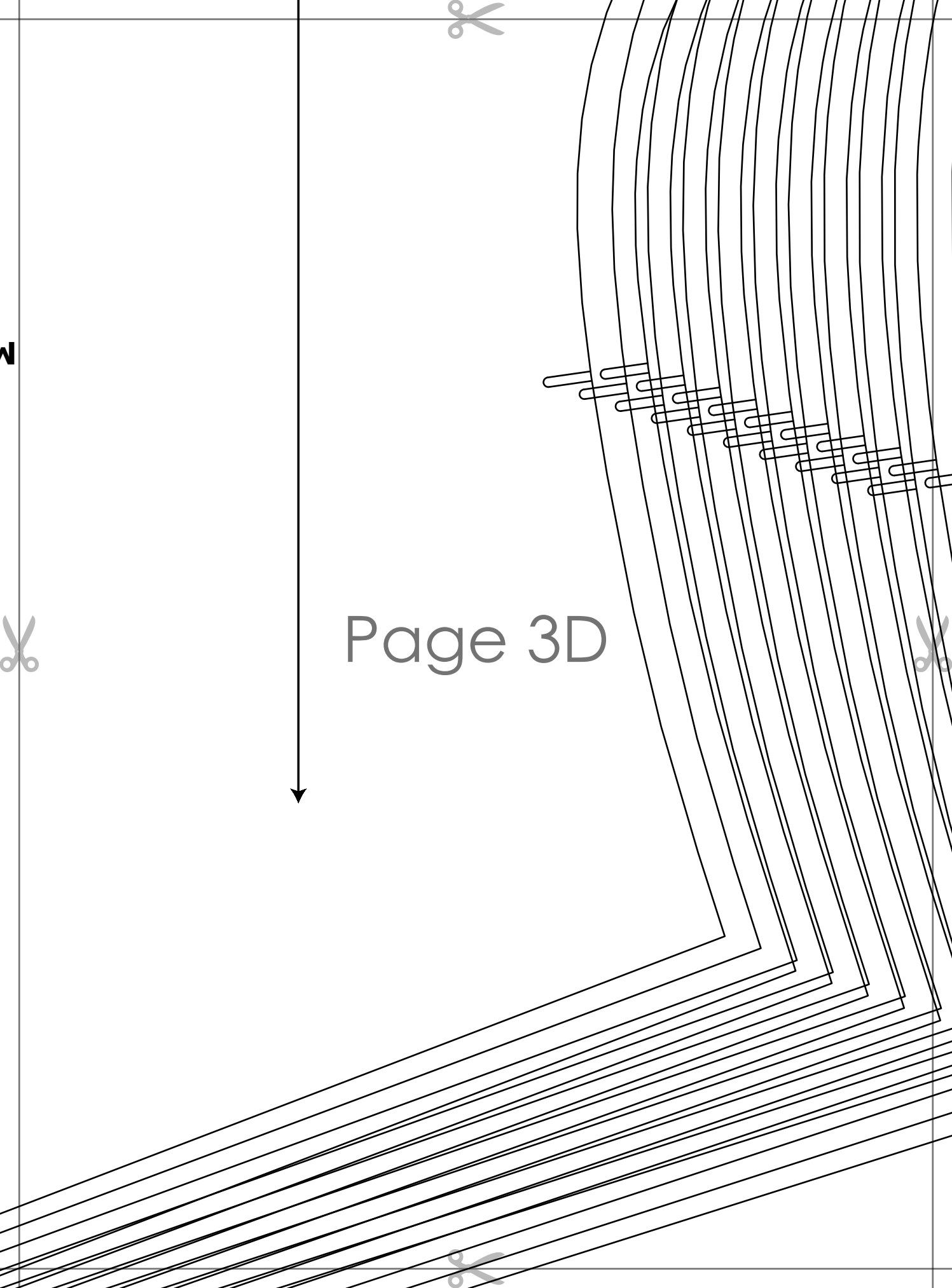

W



Page 3D



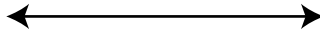

**MEN'S TURTLE NECK SWEATSHIRT  
with seam allowance**

~~Size: M~~

**SLEEVE CUFF**  
cut 2 on fold

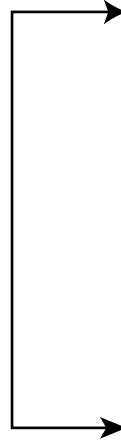

Page 3E





Page 3F

**MEN'S TU**  
**wit**



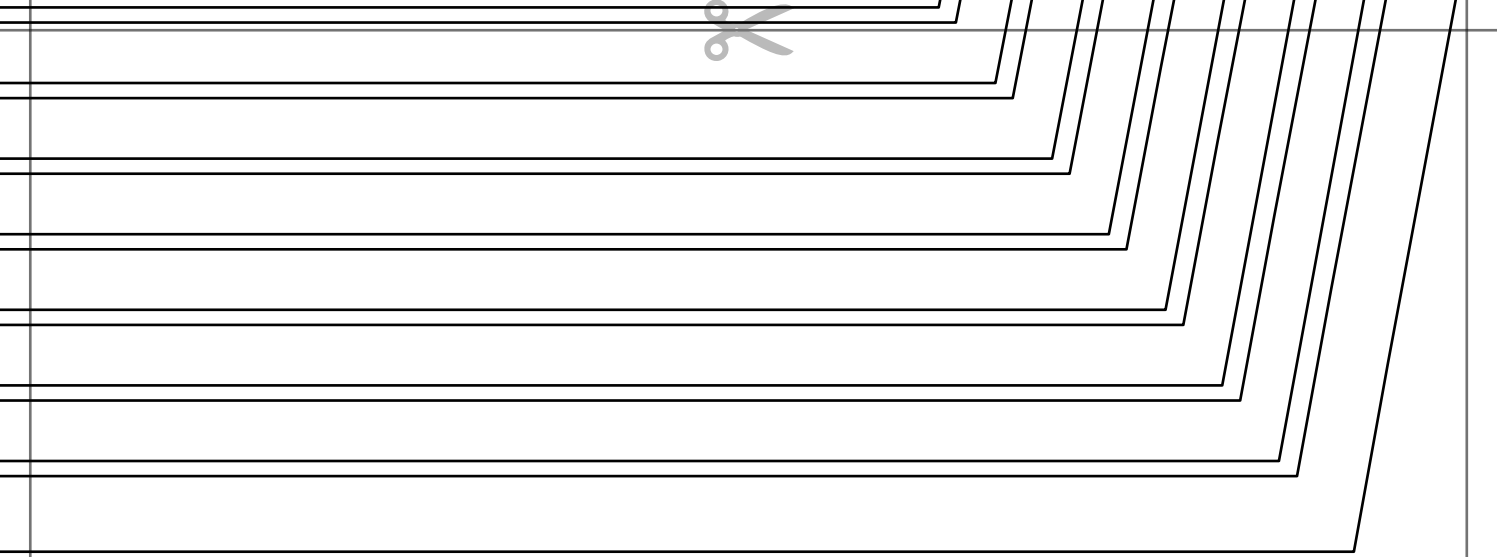

# Page 3G



**S TURTLE NECK SWEATSHIRT**  
**with seam allowance**

~~Size 2XS~~

**NECK BAND**  
**cut 1 on fold**

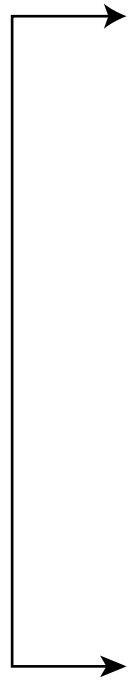
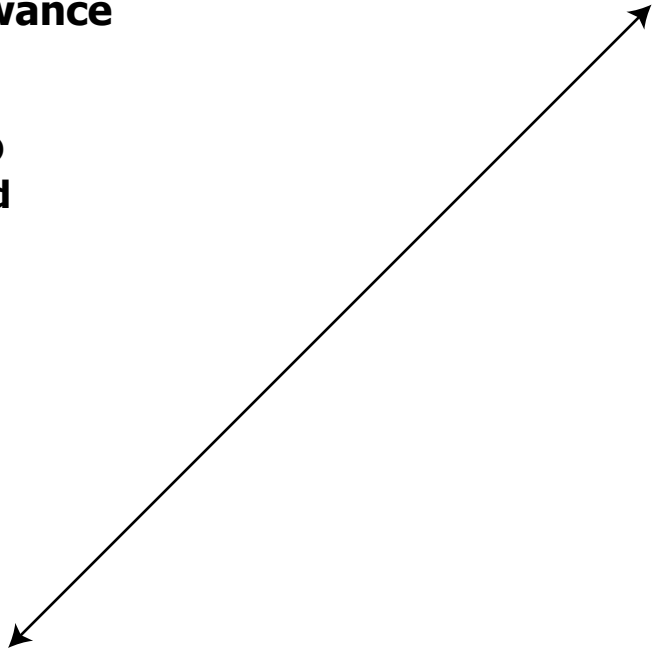



Page 4A





Page 4B



**MEN'S TURTLE NECK SWEATSHIRT**  
**with seam allowance**

**Size: M**

**HEM**  
**cut 1**

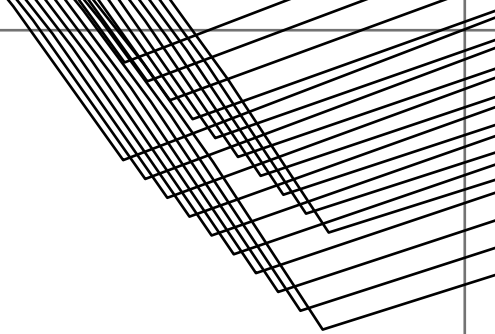
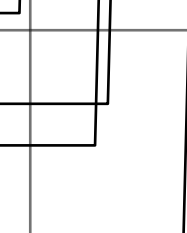

**WEATSHIRT**  
**ance**



Page 4C



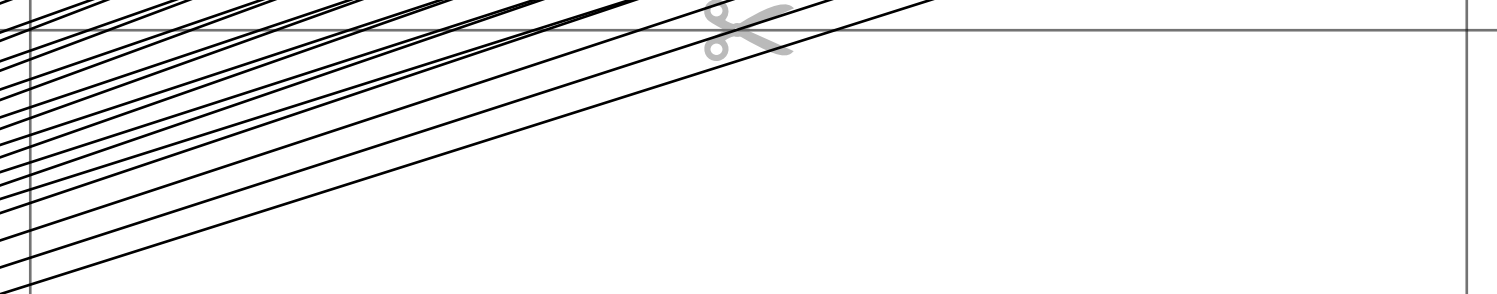

Page 4D





Page 4E





