

TEST SQUARE

Page 1 A

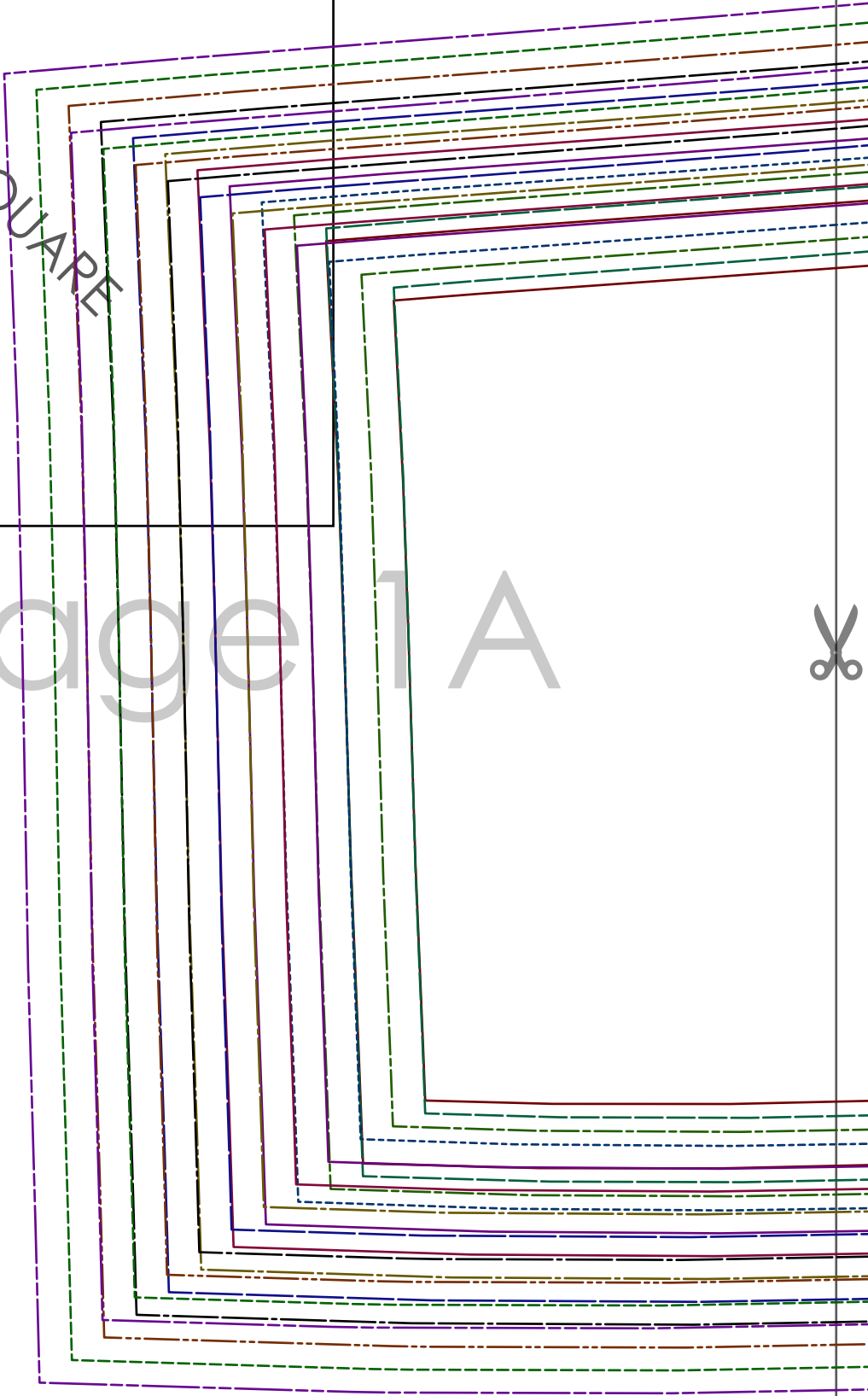

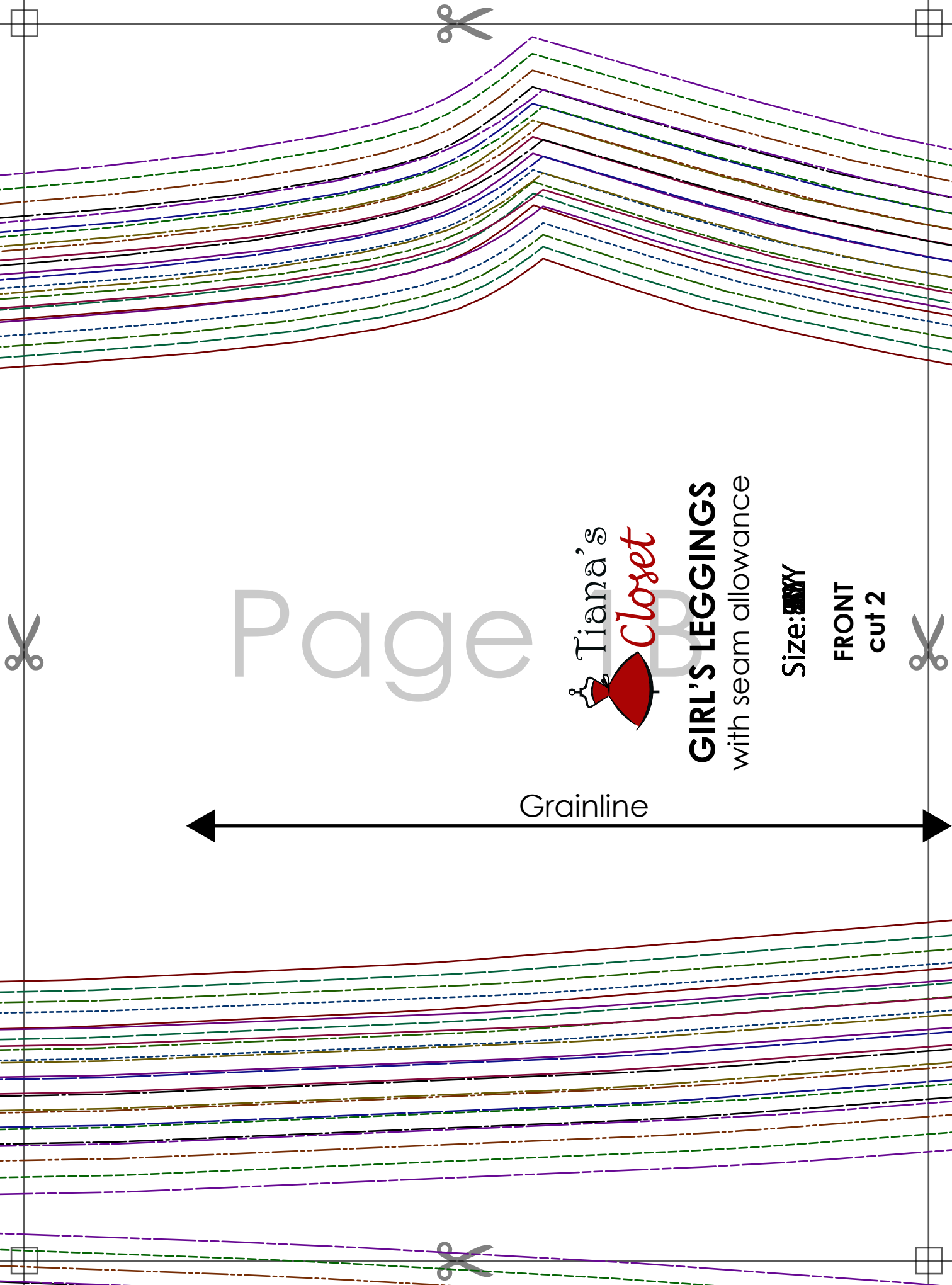

Page



**GIRL'S LEGGINGS**  
with seam allowance

Size: ~~XXXX~~ Y

**FRONT**  
cut 2

Grainline

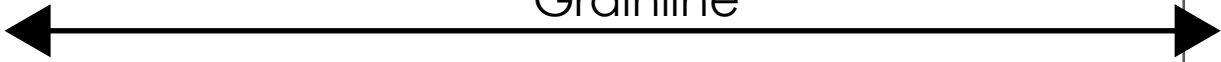

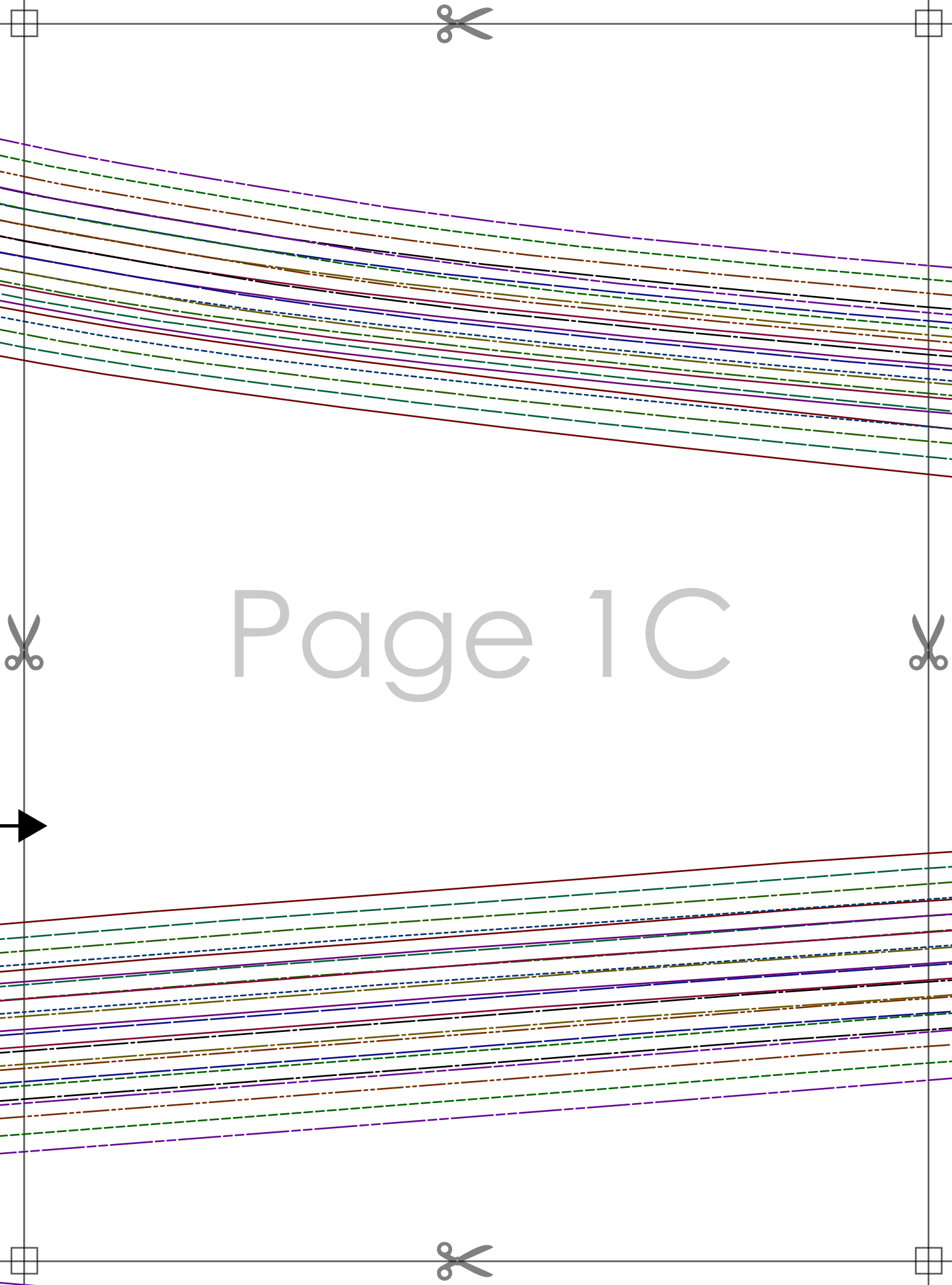

Page 1C

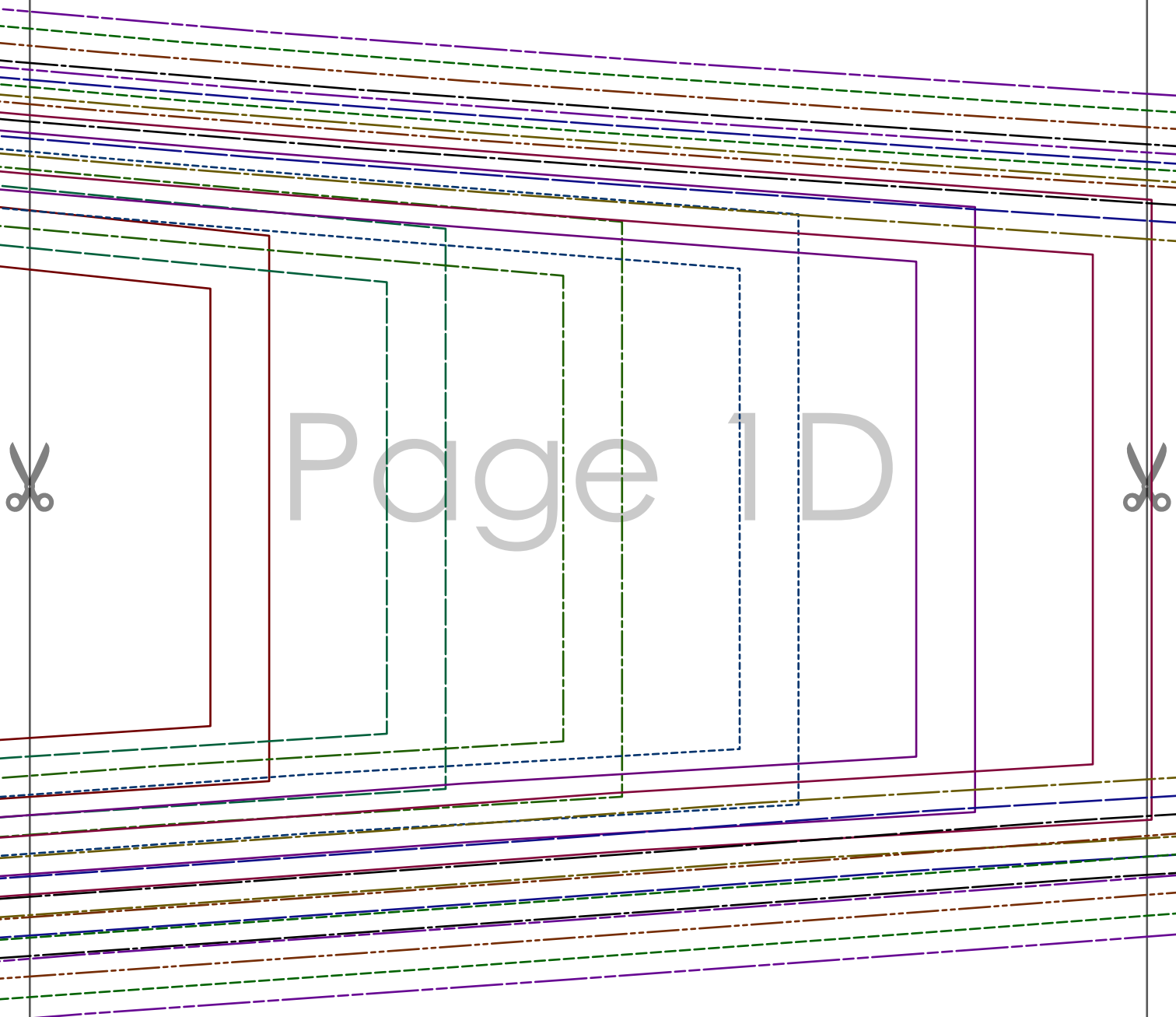

Page 1D

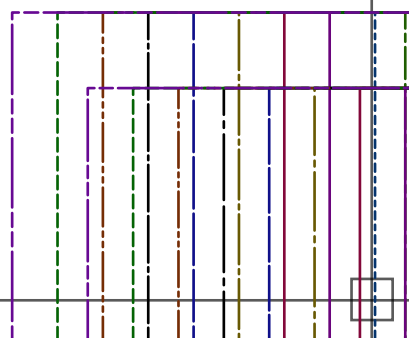

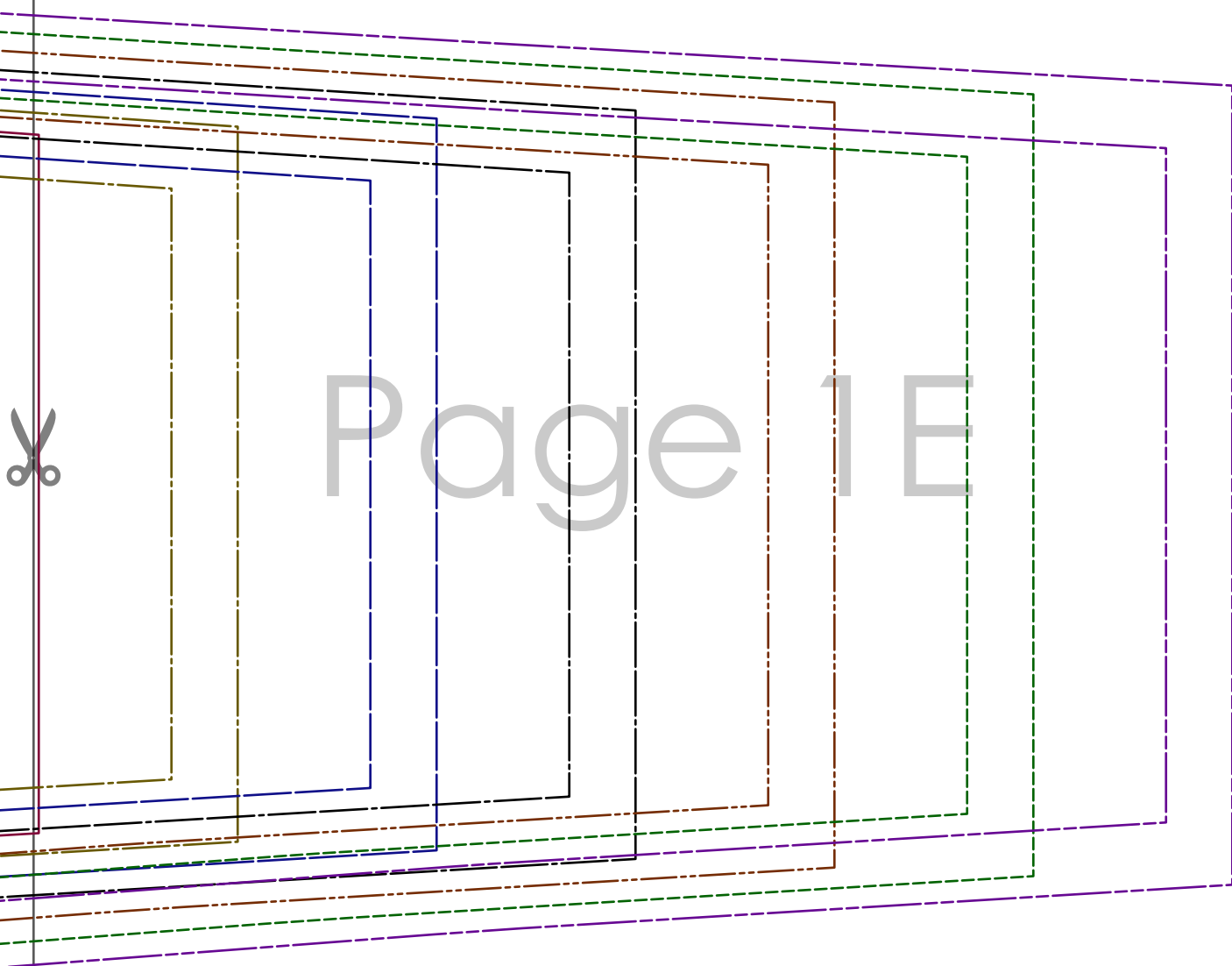

Page 1 E



**GIRL'S LEGGINGS**  
with seam allowance

Size: **8/9**

WAISTBAND



Grainline

fold along this line

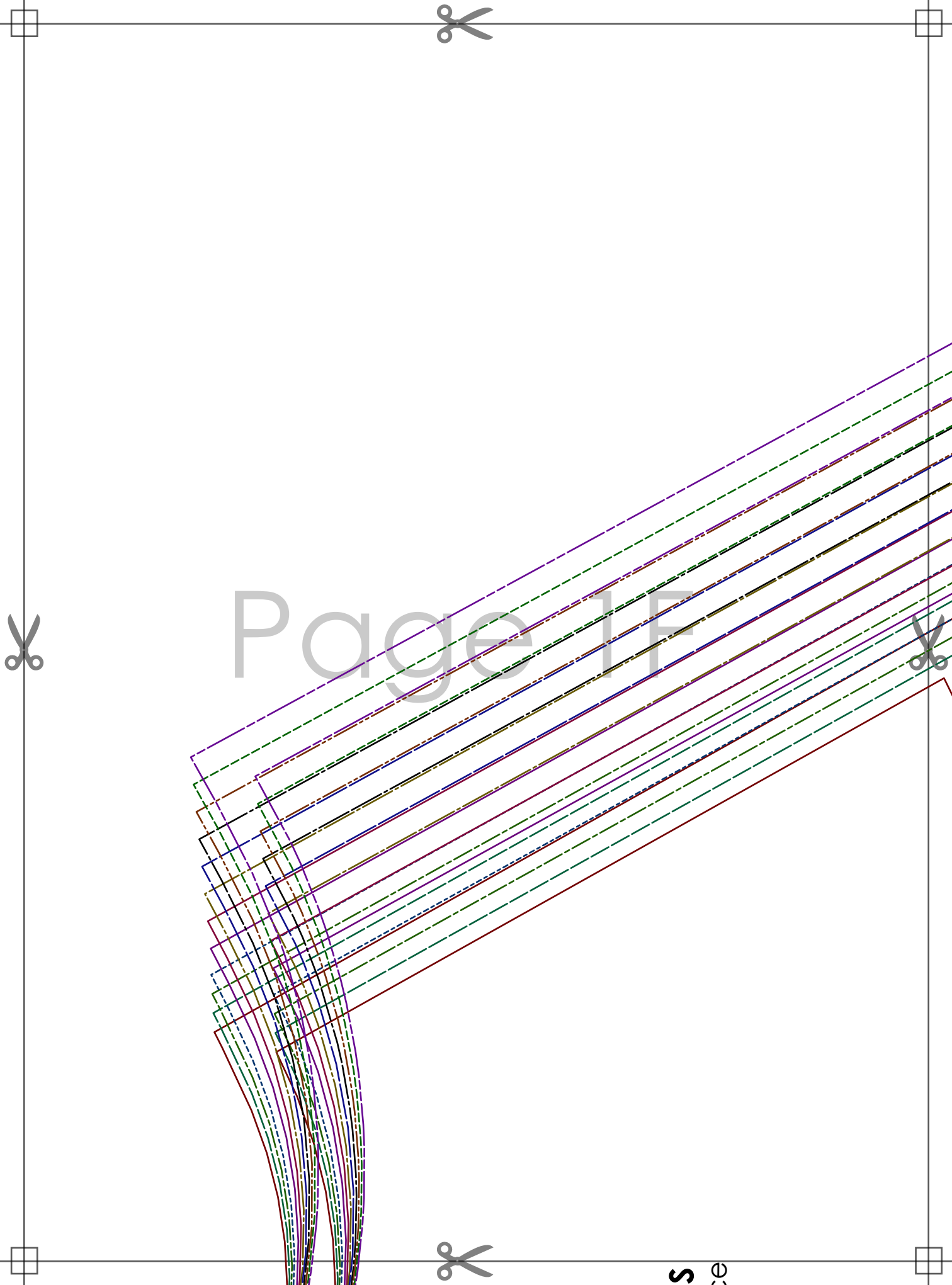

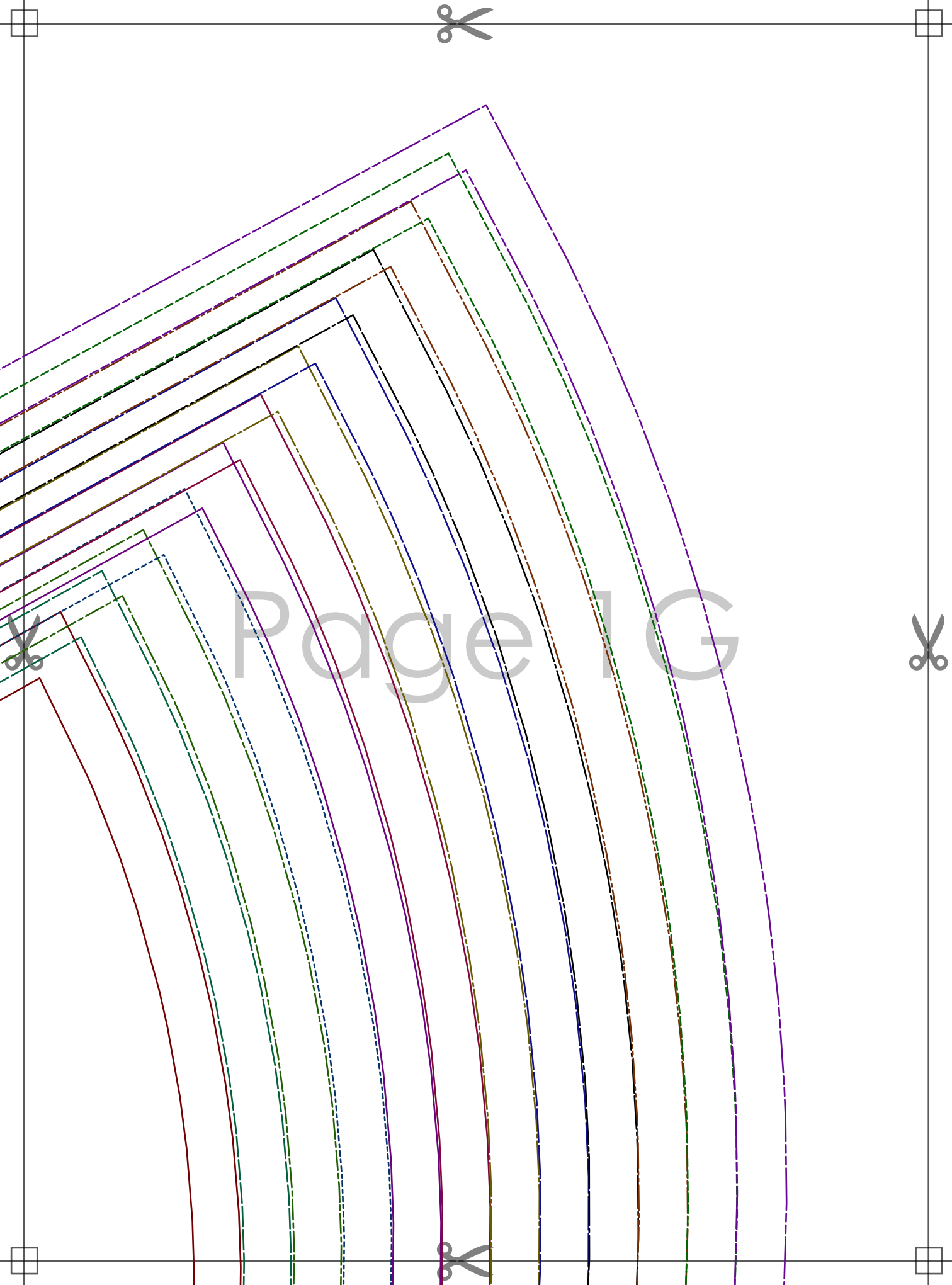

Page 1 G

Page 2A

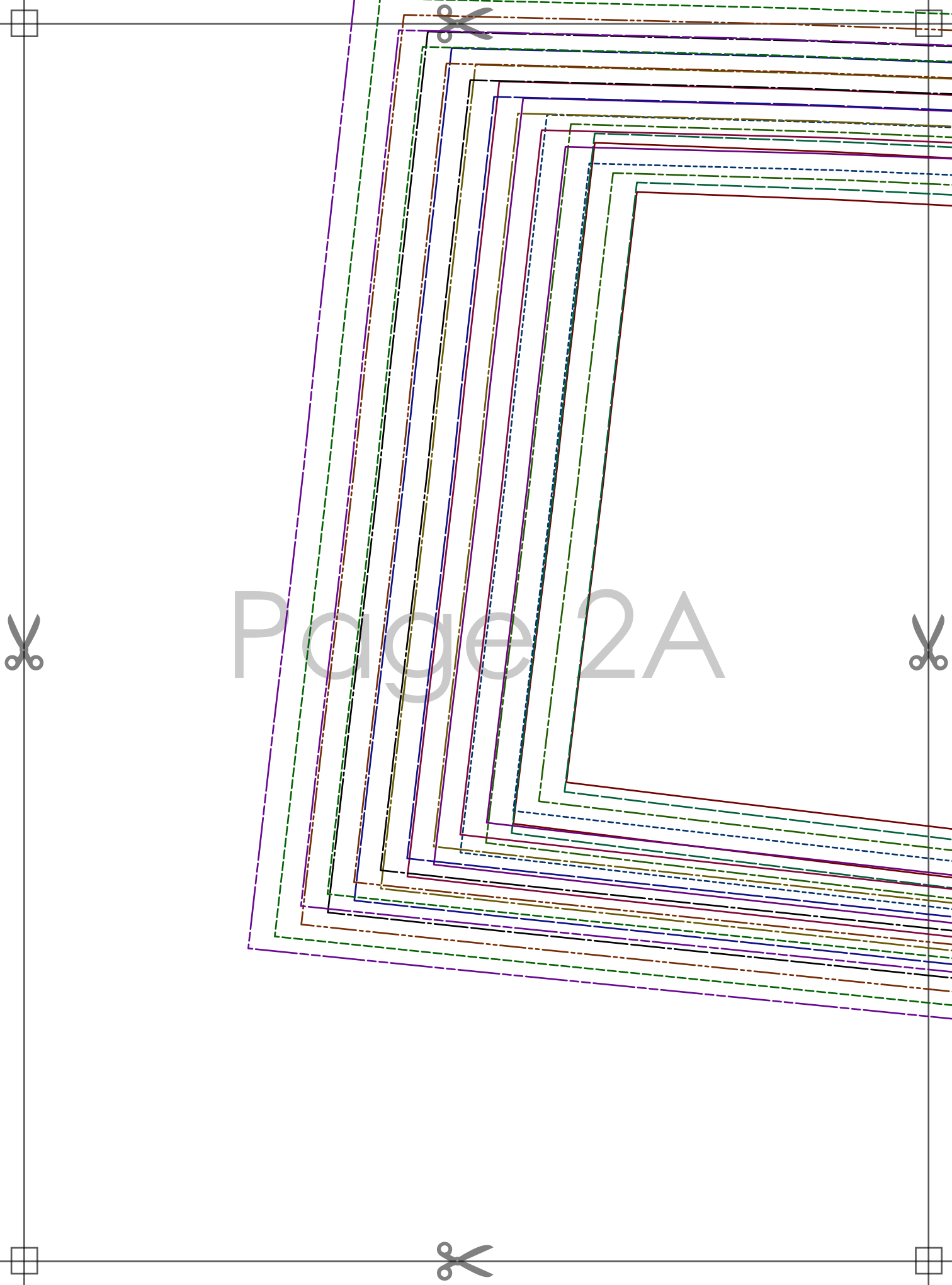



Page 28



**GIRL'S LEGGINGS**  
with seam allowance

Size: **XXY**

**BACK**  
cut 2

Grainline

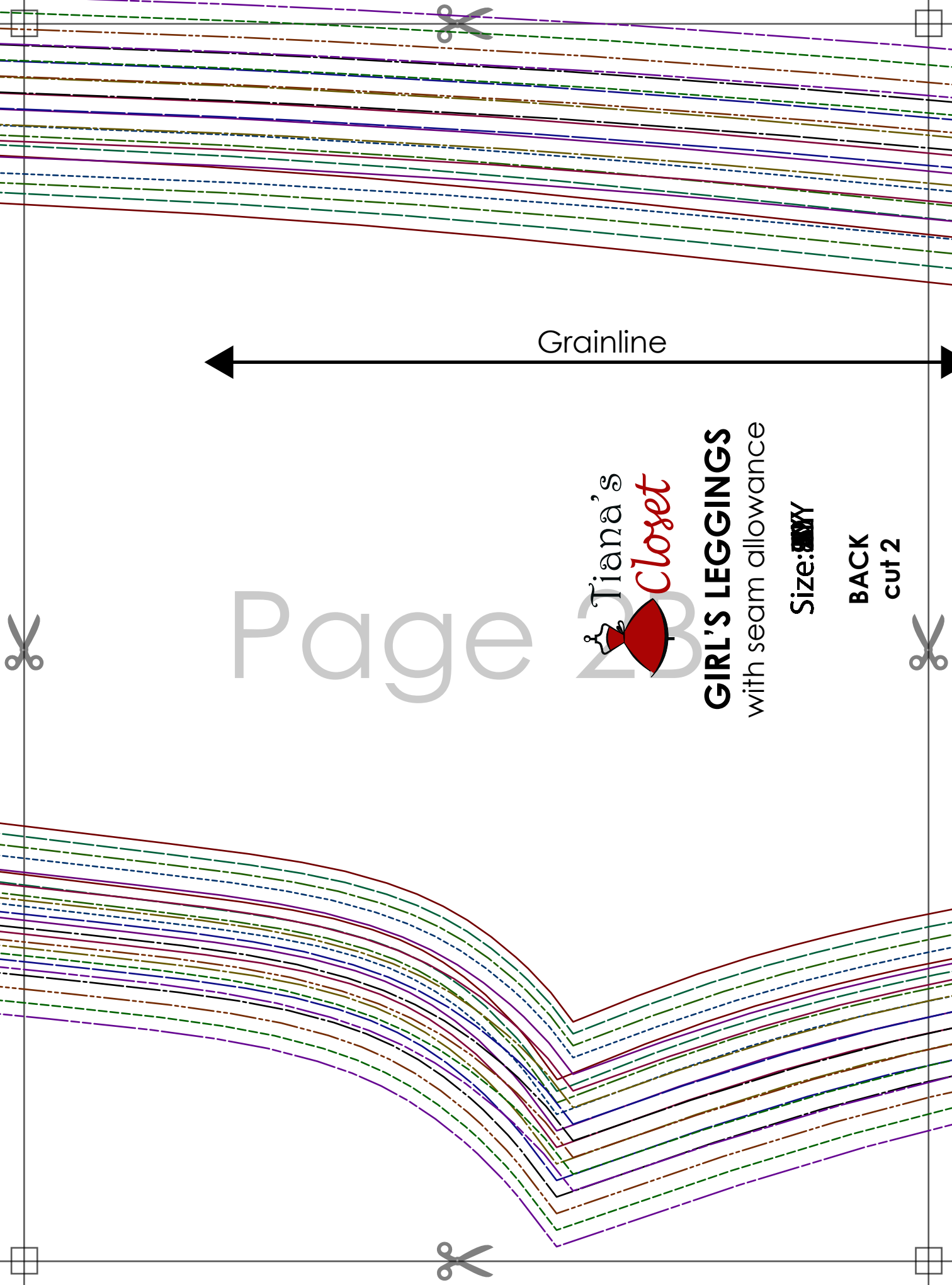
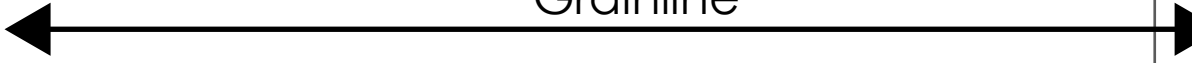

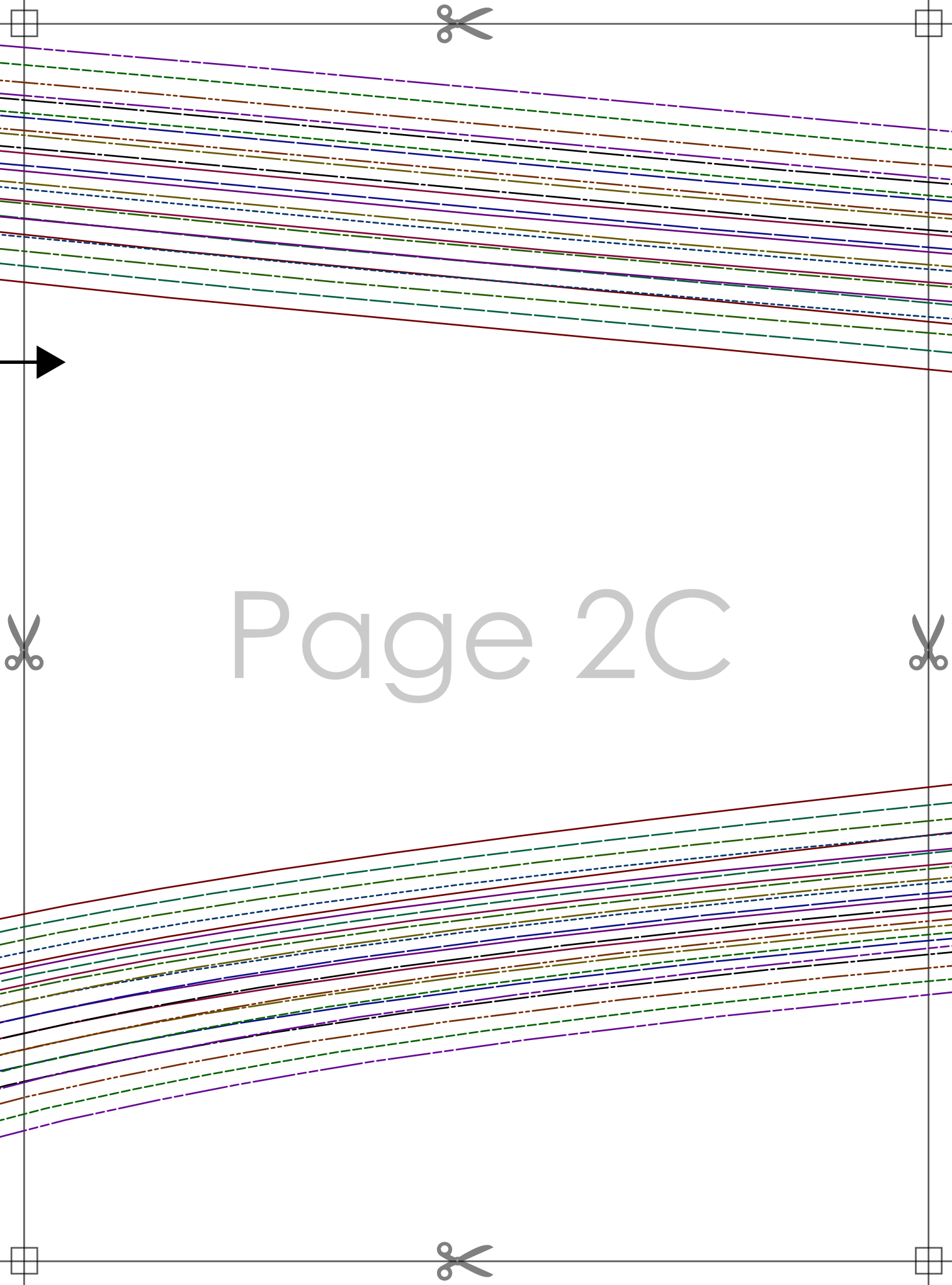

Page 2C

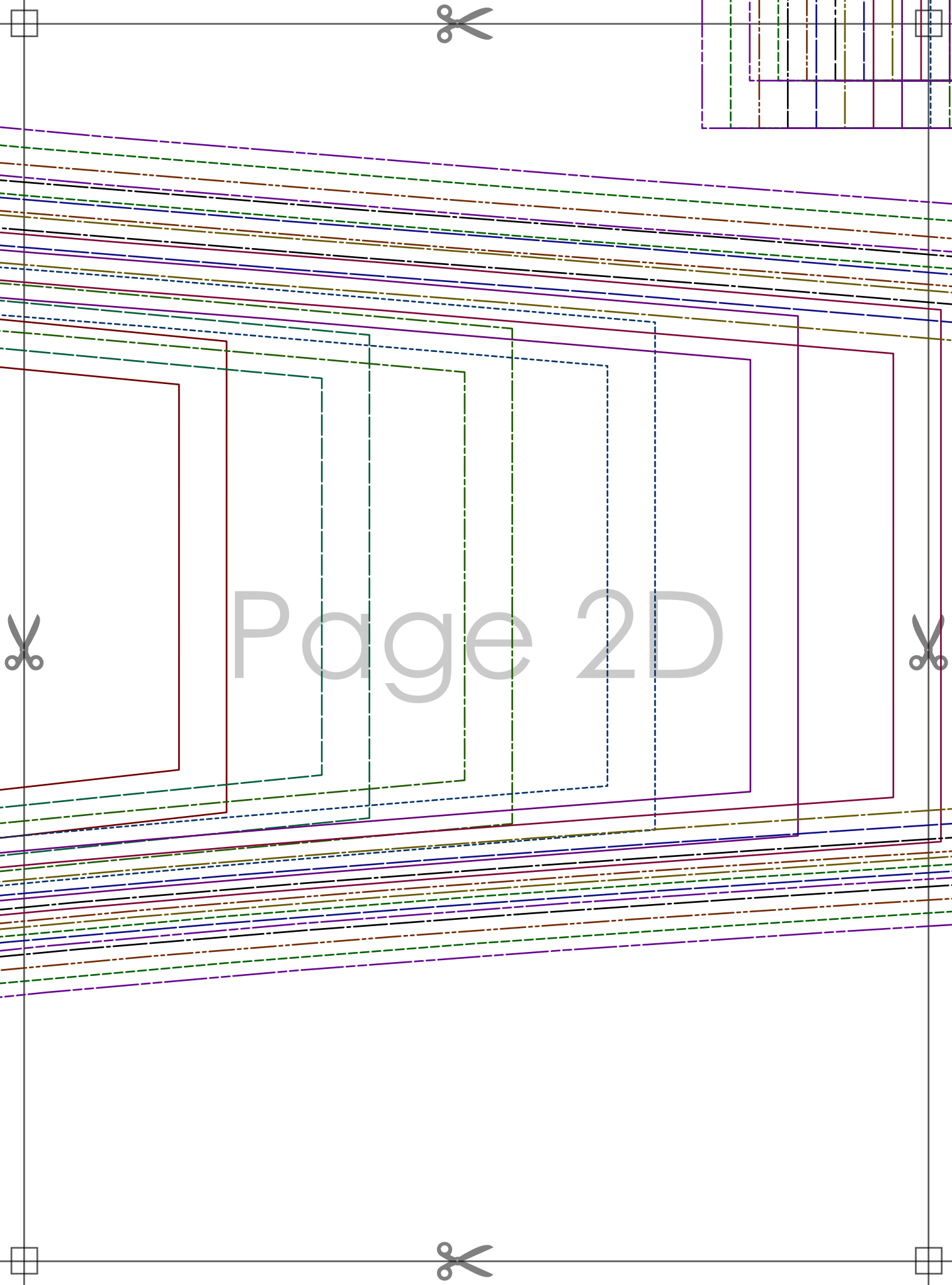

Page 2D

Size: **WY**  
WAISTBAND  
cut 2 on fold



line  
↓

Fold along

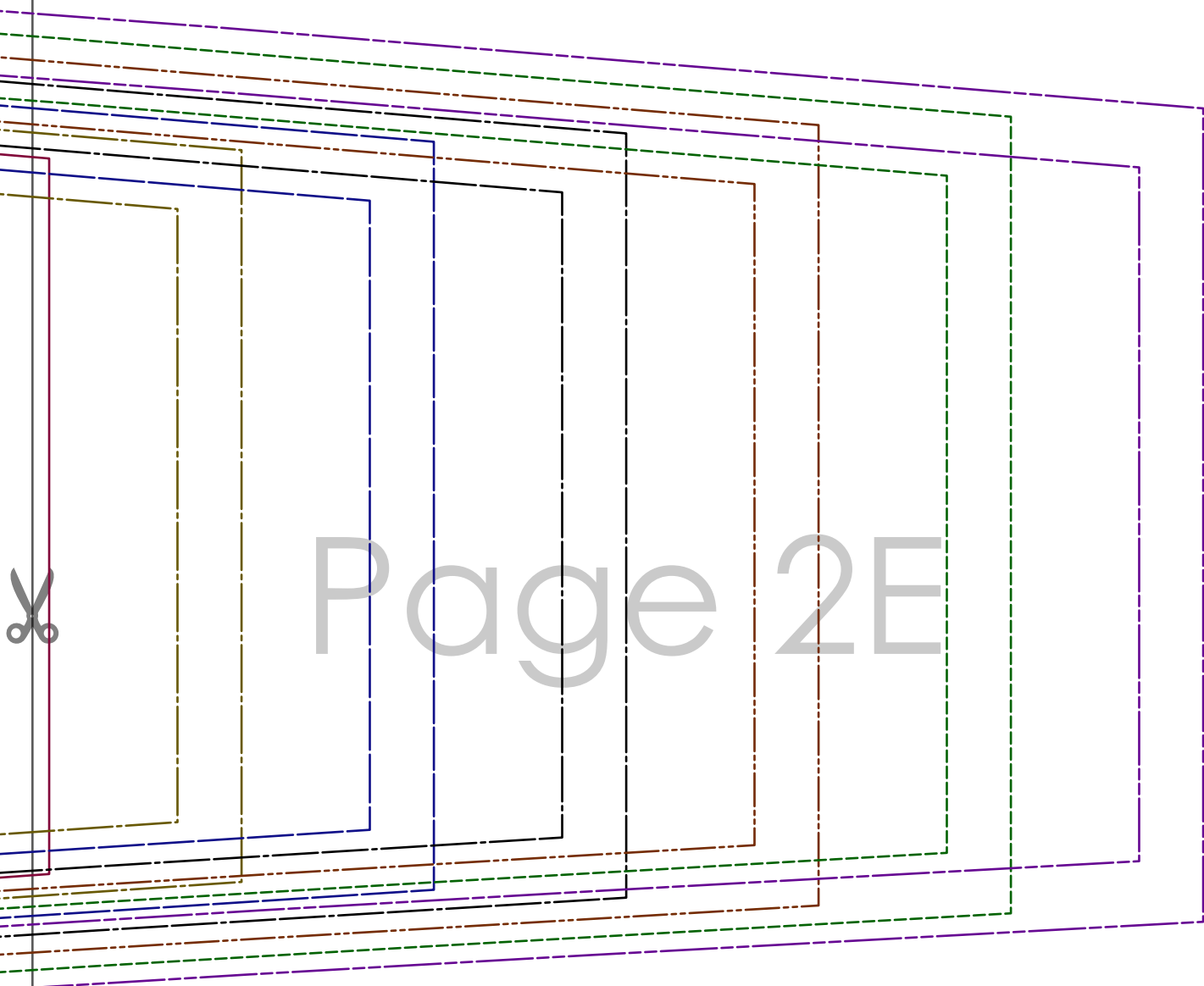

Page 2E





# GIRL'S LEGGINGS

with seam allowance

Size: ~~XXXX~~

SKIRT

cut 2 on fold

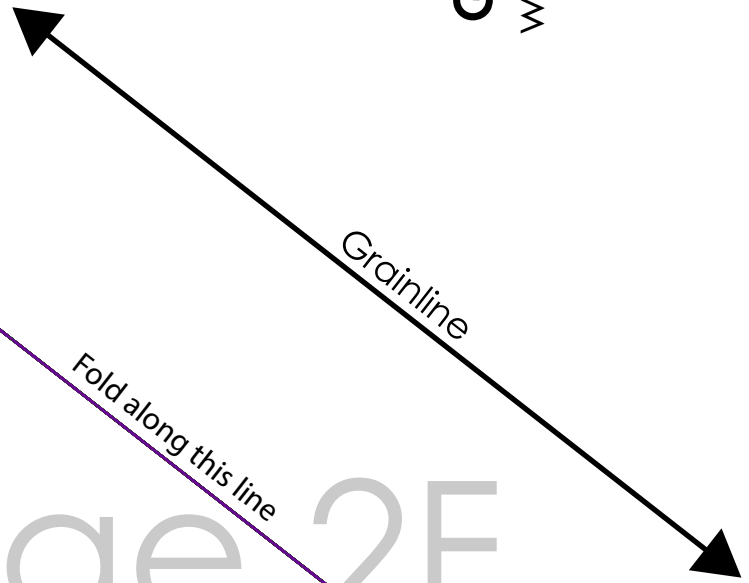
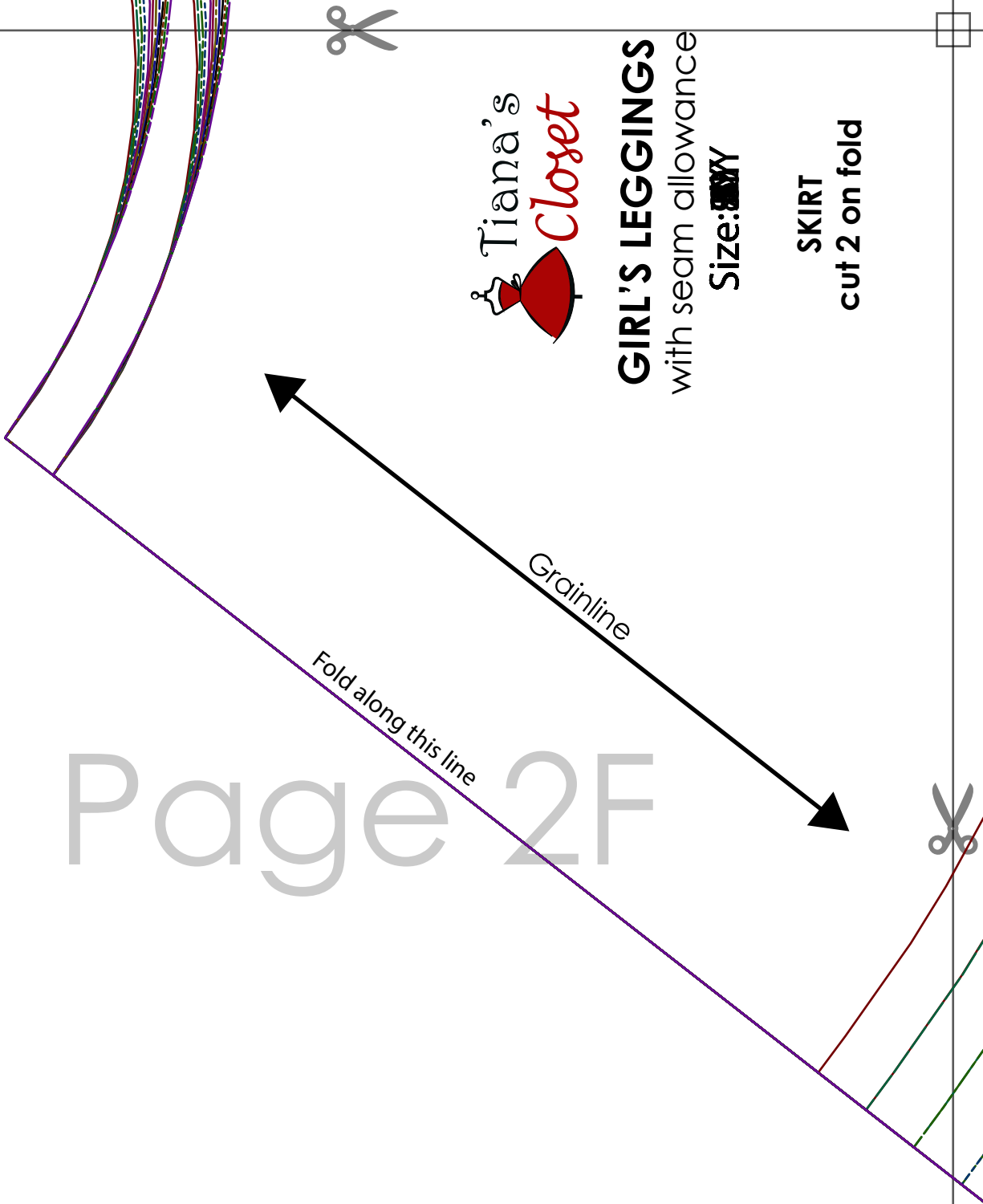

Page 2F

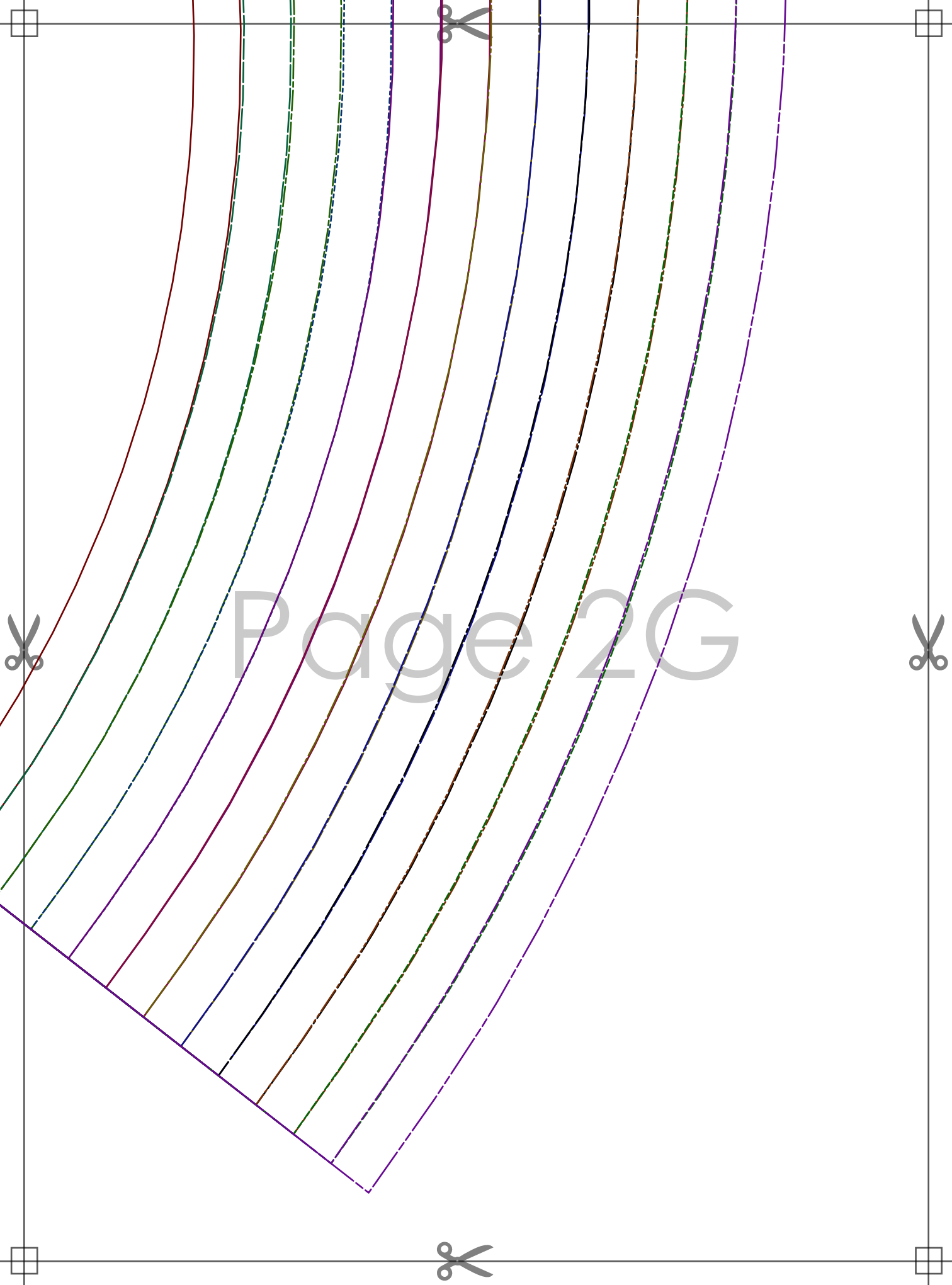

Page 2G