

Page 1 A

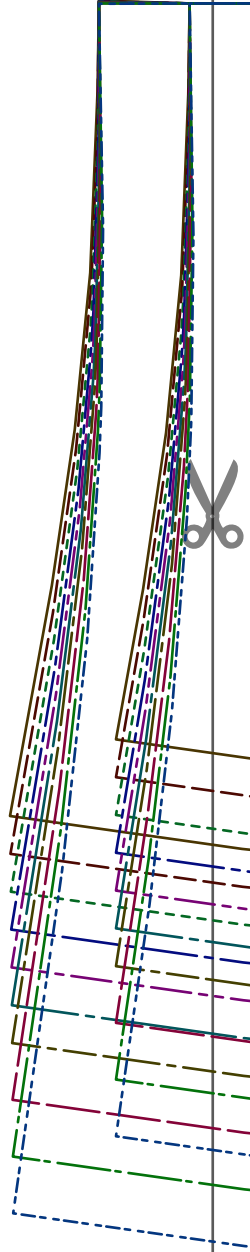

Page 1

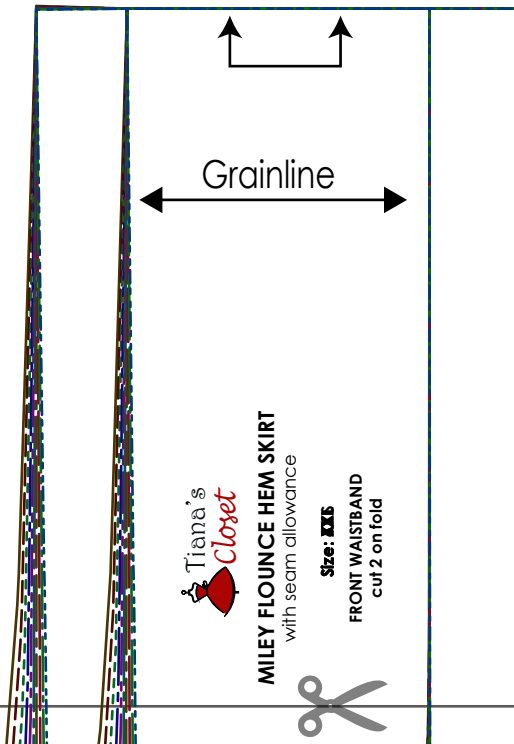

**MILEY FLOUNCE HEM SKIRT**

with seam allowance

**Size: XS**

**CENTER FRONT  
cut 1 on fold**

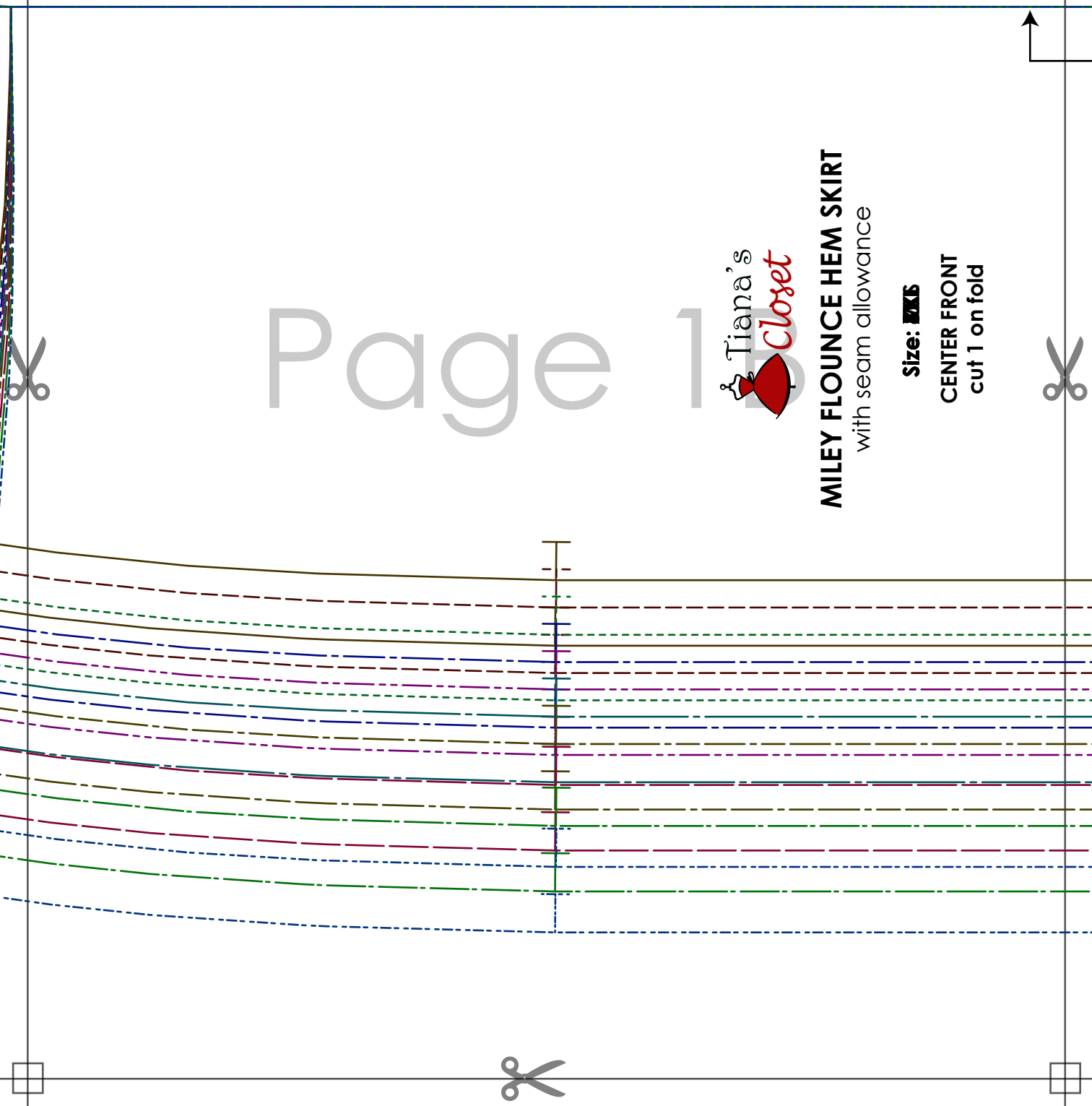



Page 1C



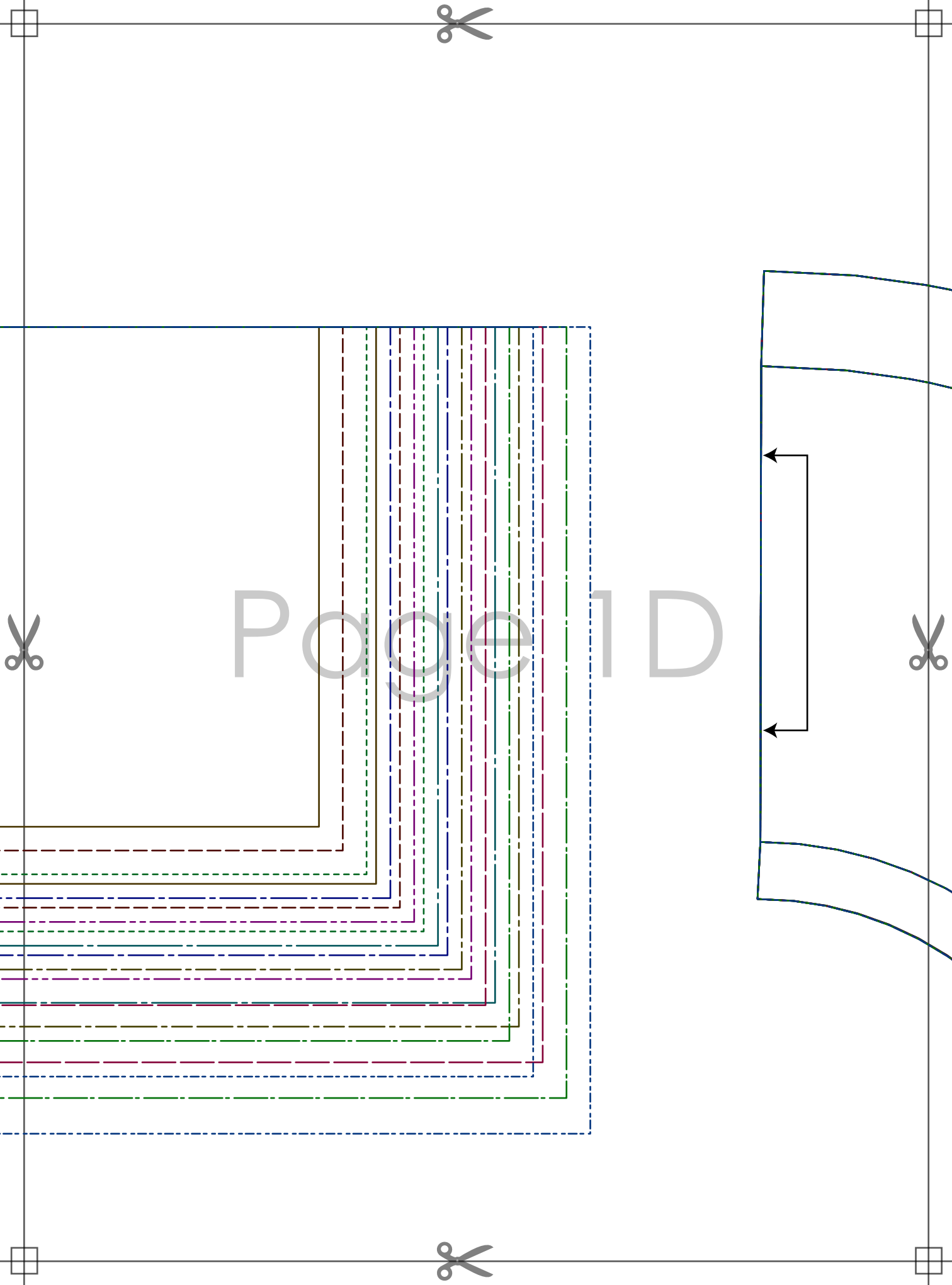

Page 1 D

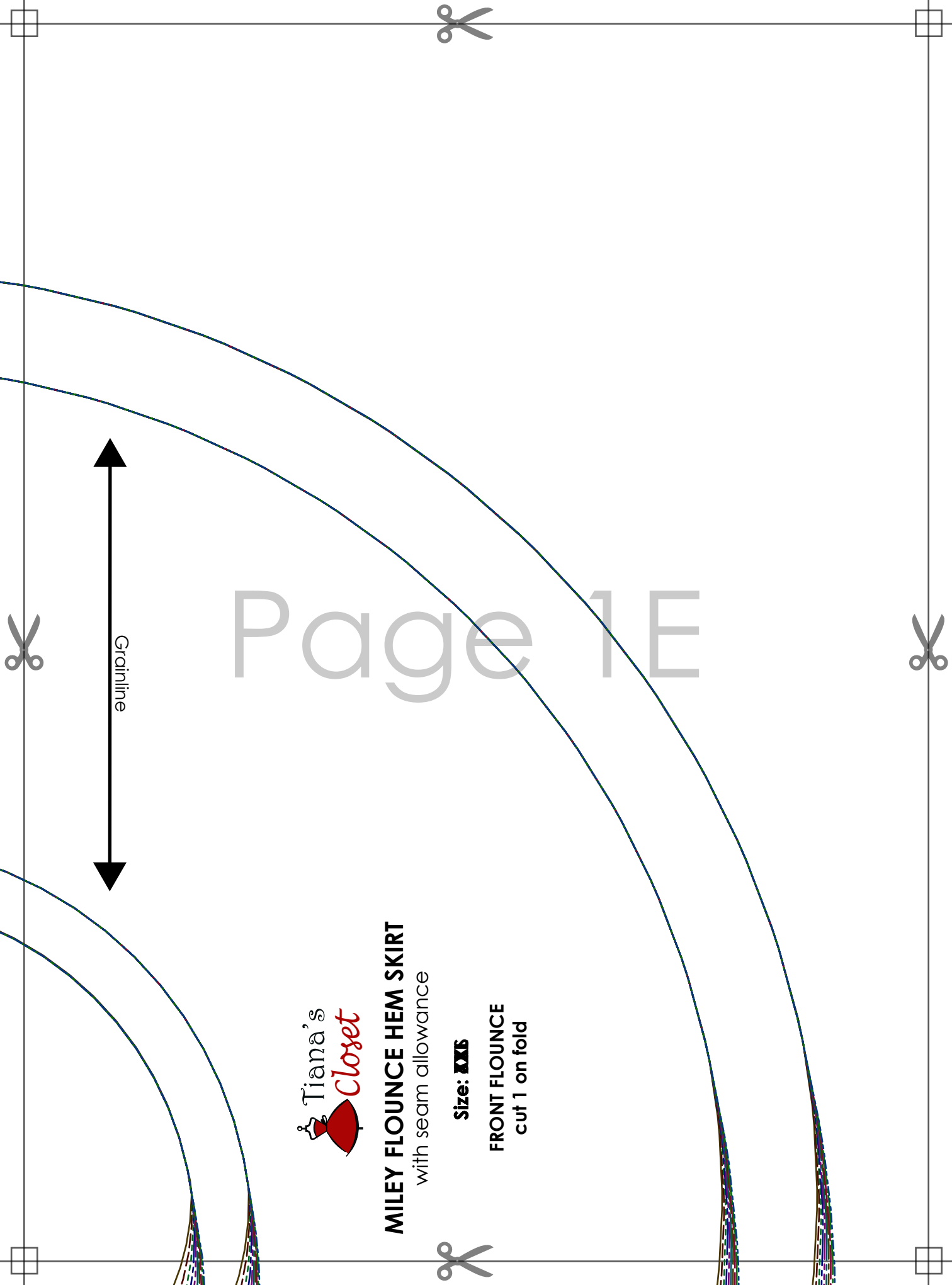

Page 1E



**MILEY FLOUNCE HEM SKIRT**  
with seam allowance

**Size: XXS**

**FRONT FLOUNCE**  
cut 1 on fold

Grainline

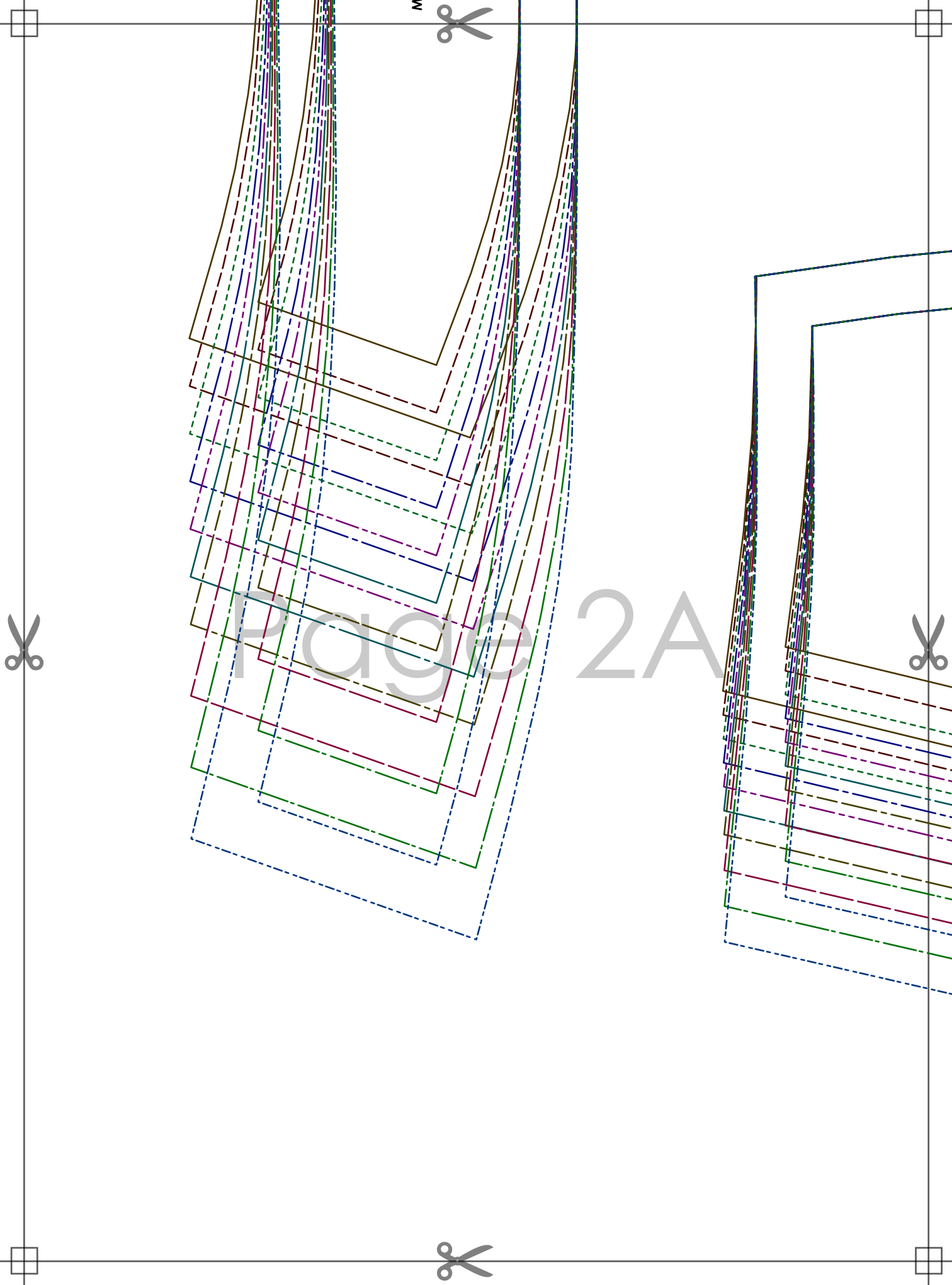

Page 2B



**MILEY FLOUNCE HEM SKIRT**  
with seam allowance

**Size: XS**  
**SIDE FRONT**  
cut 2

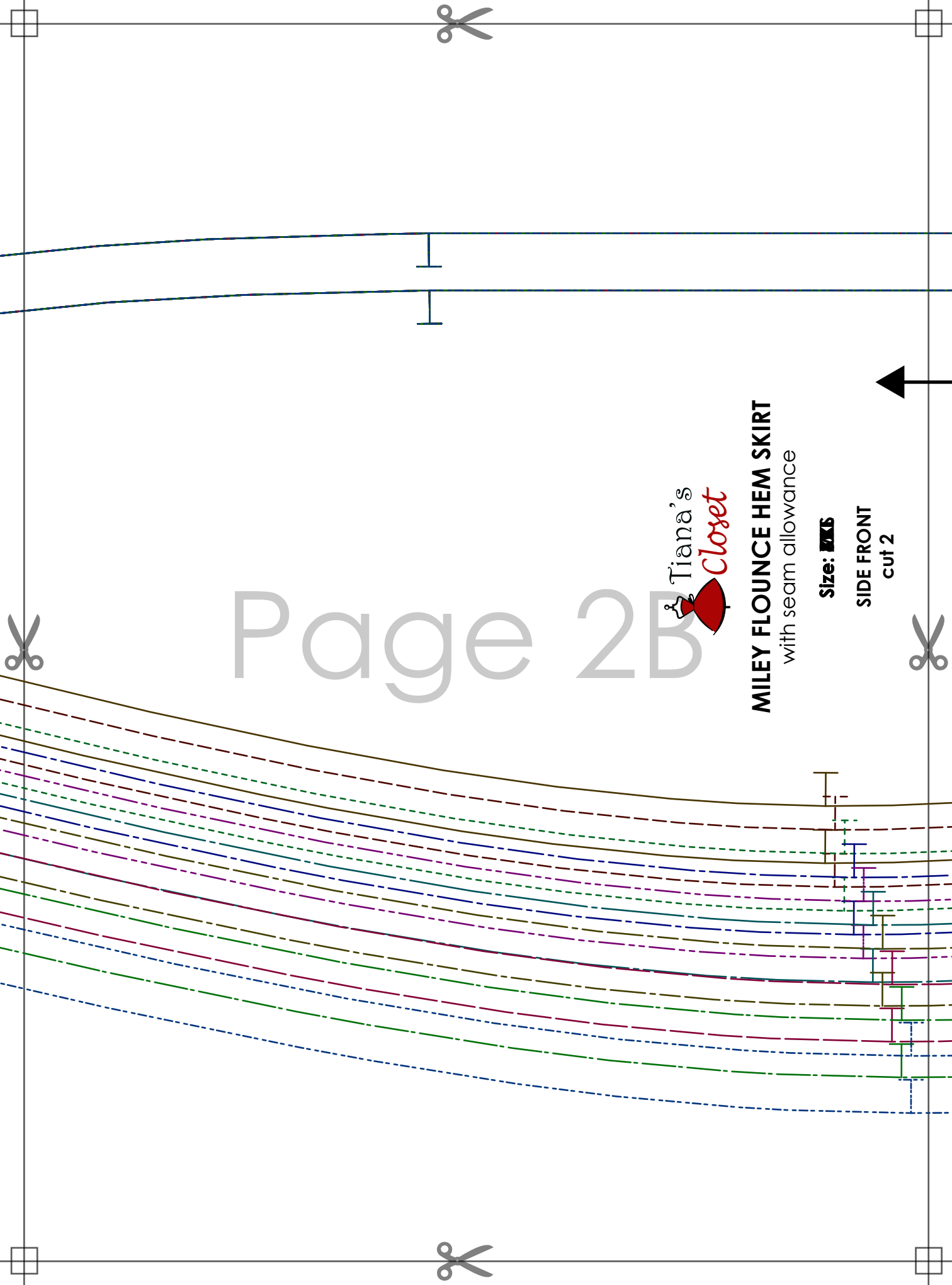
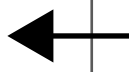



Grainline



Page 2C





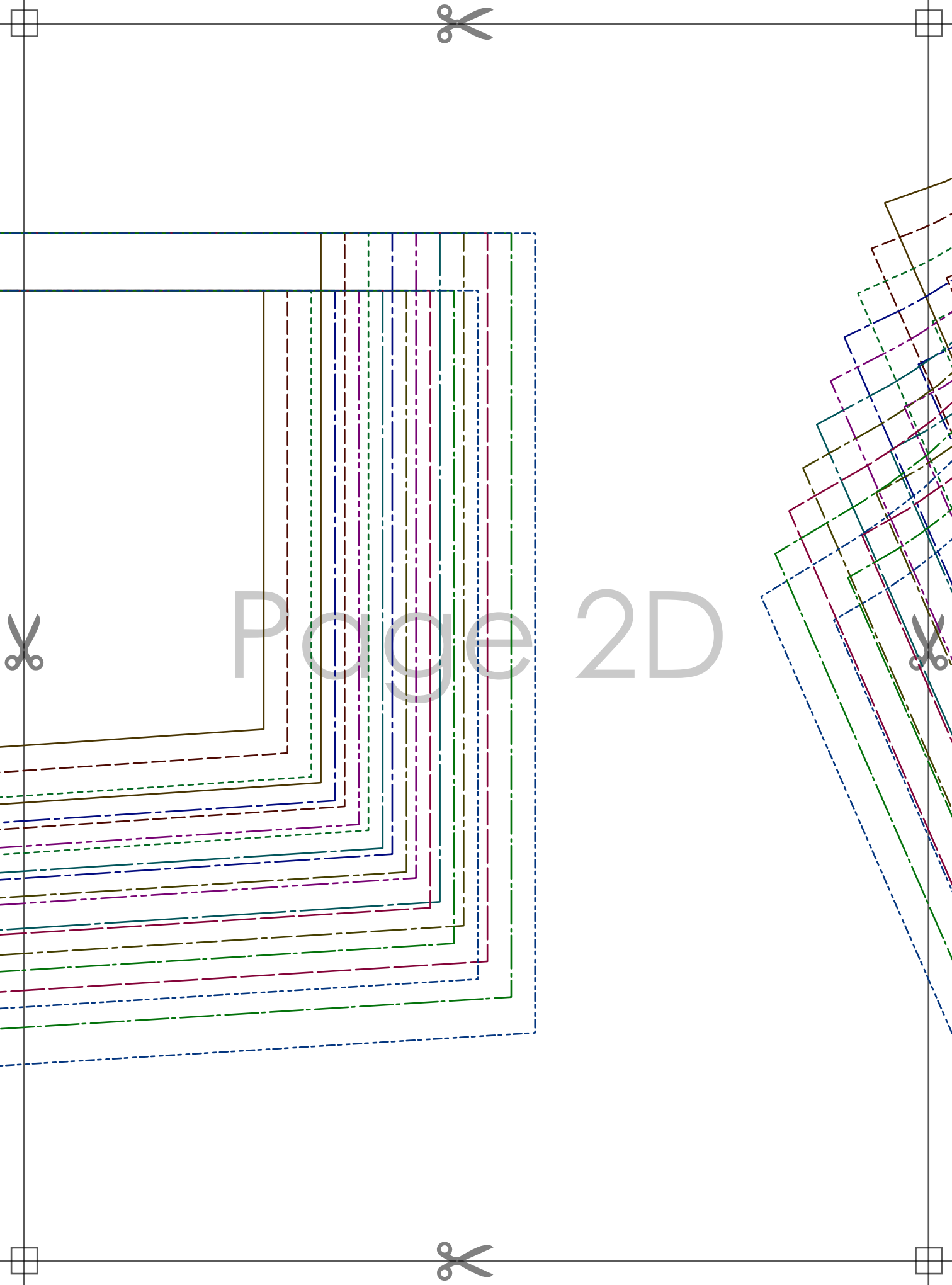

Page 2D

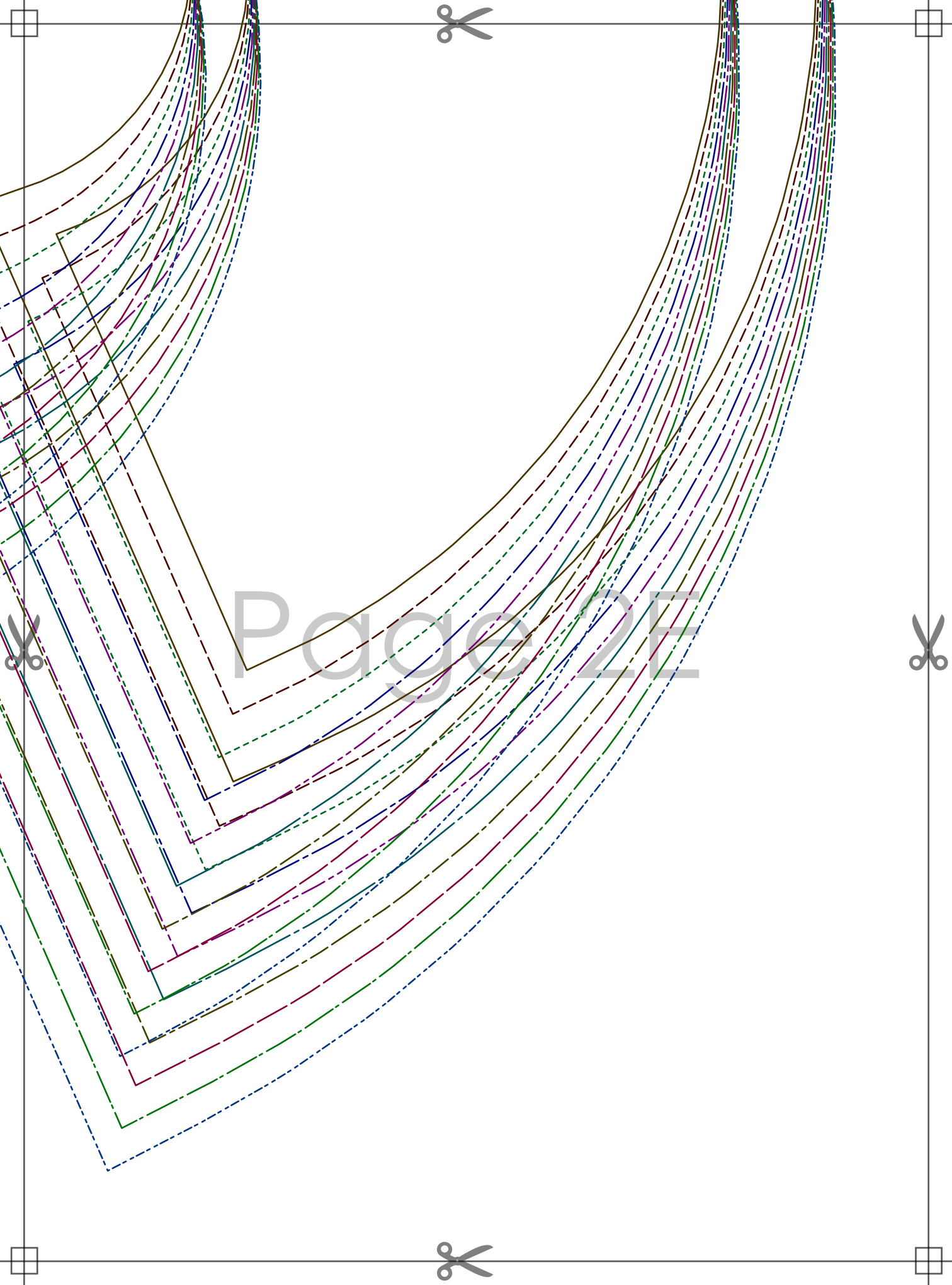

Page 2E

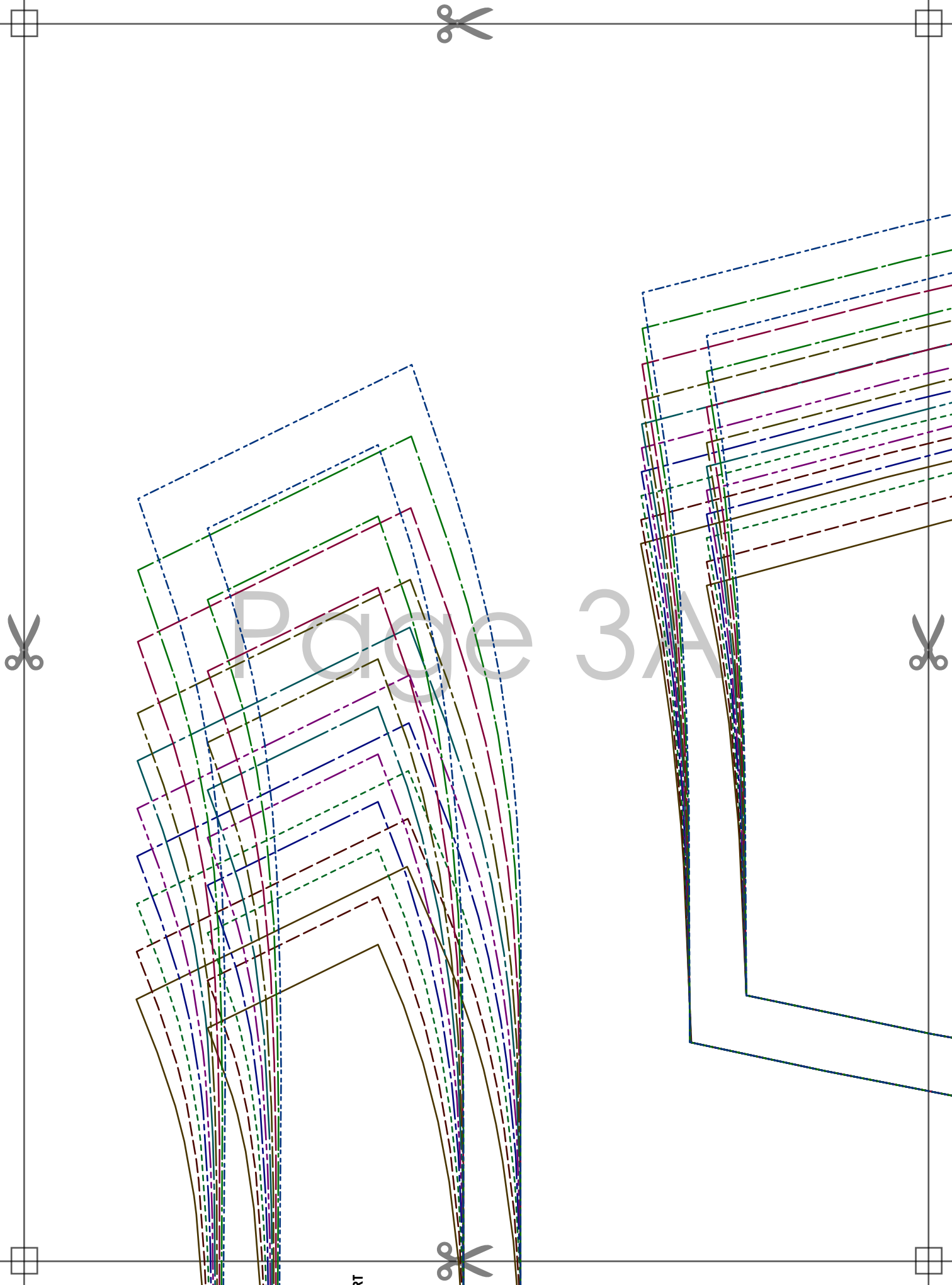

Page 3A

RT

Page 3B



**MILEY FLOUNCE HEM SKIRT**

with seam allowance

**Size: XXS**

**SIDE BACK  
cut 2**

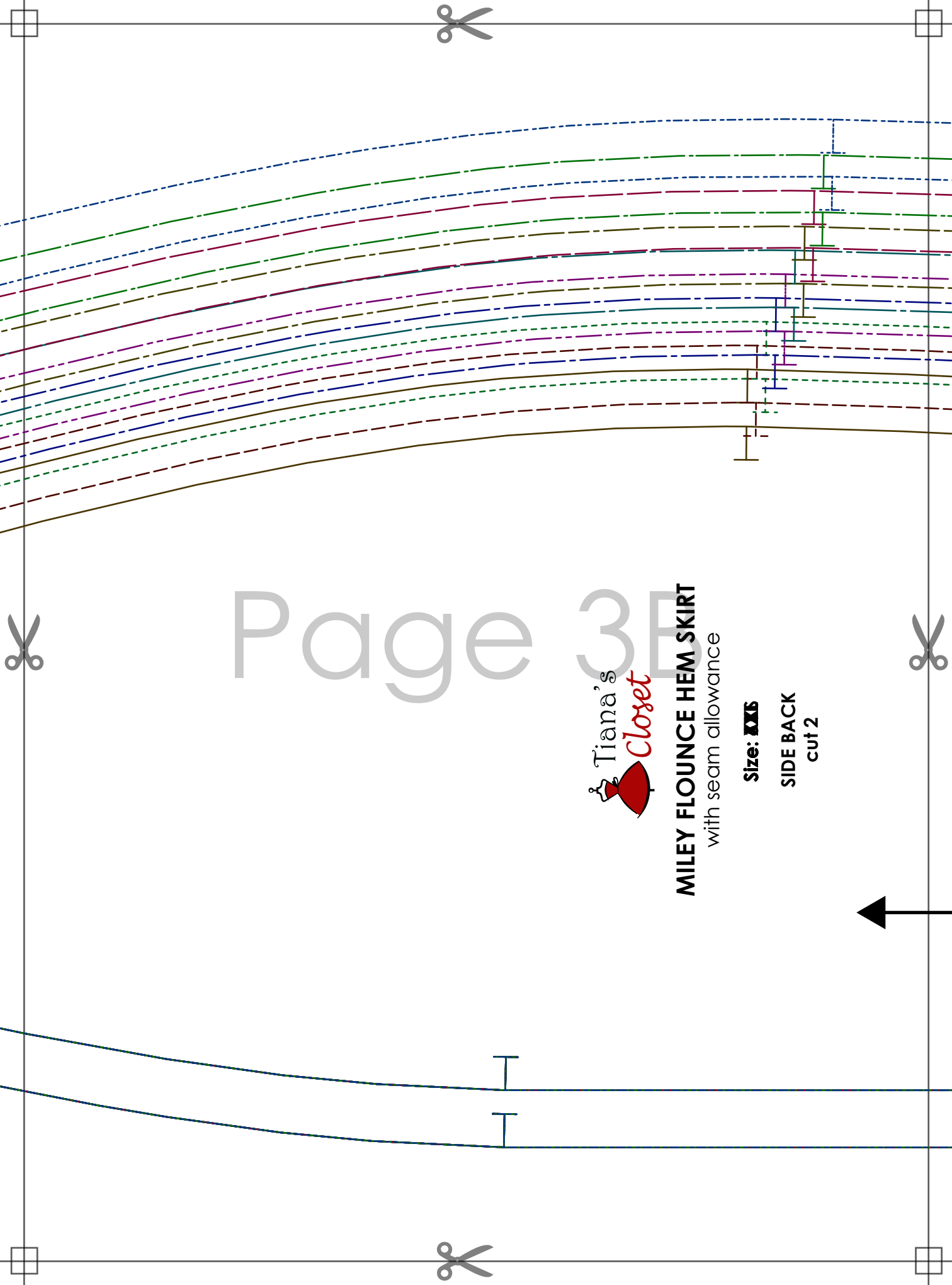

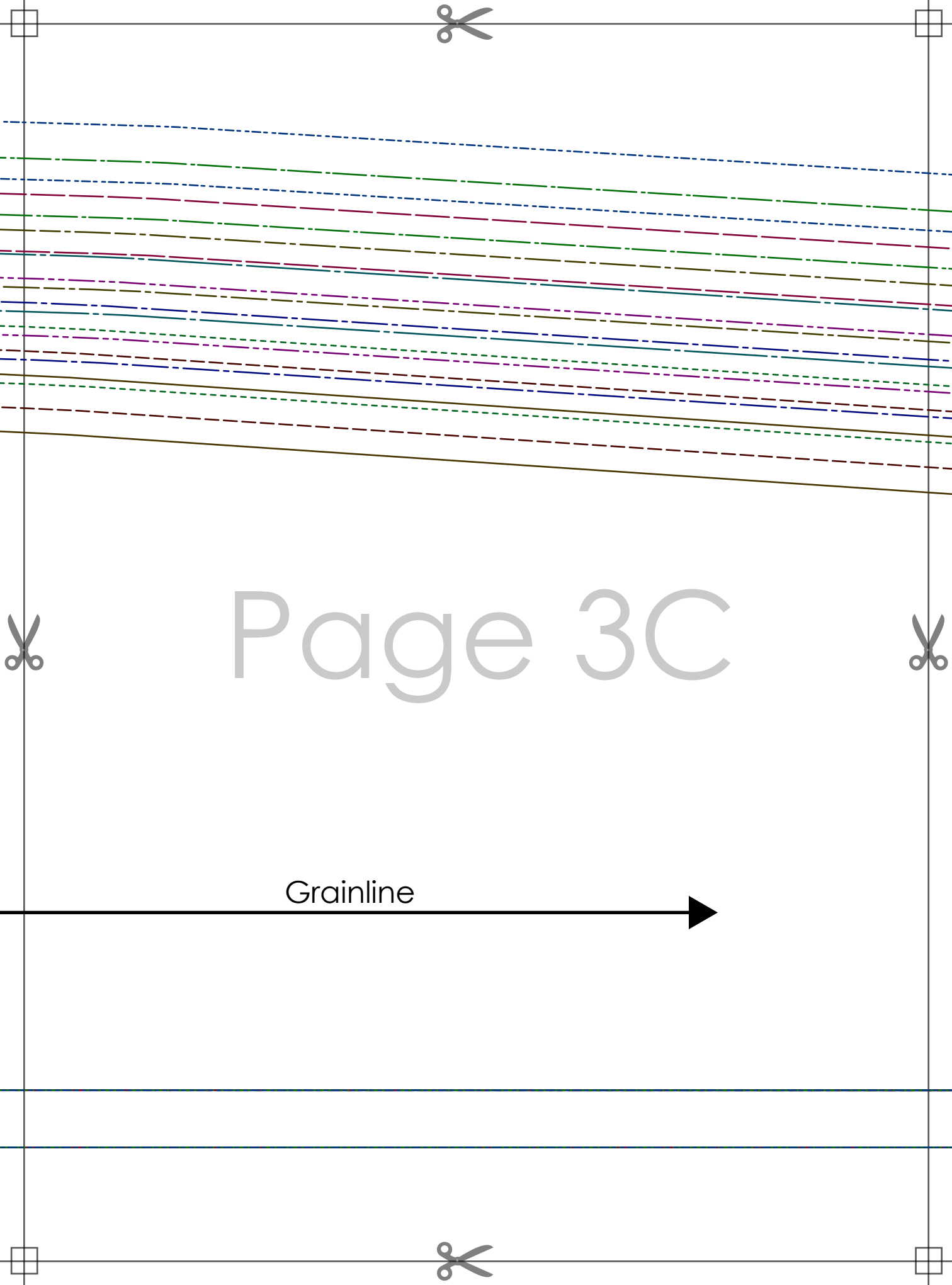

Page 3C

Grainline



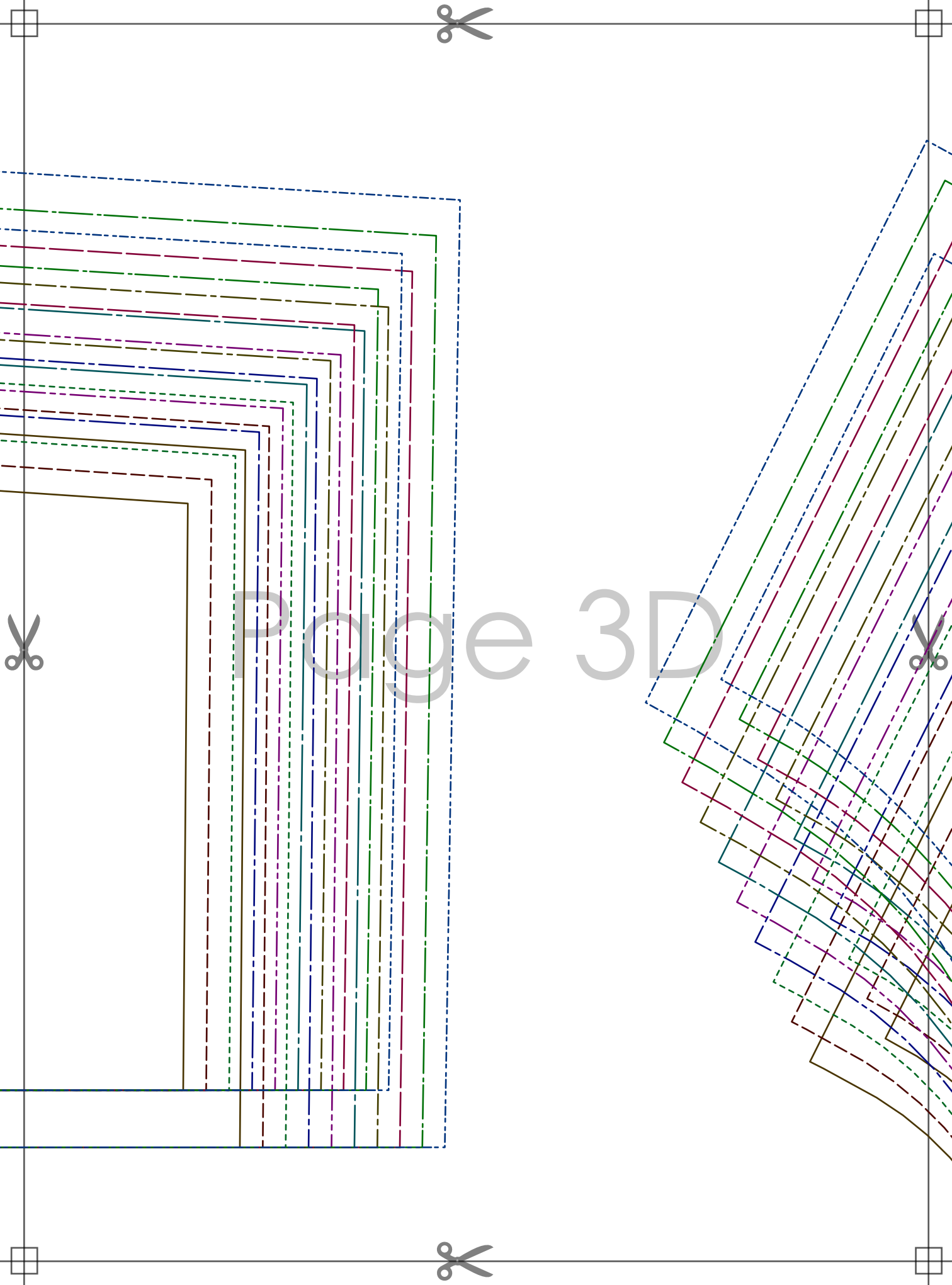

Page 3D

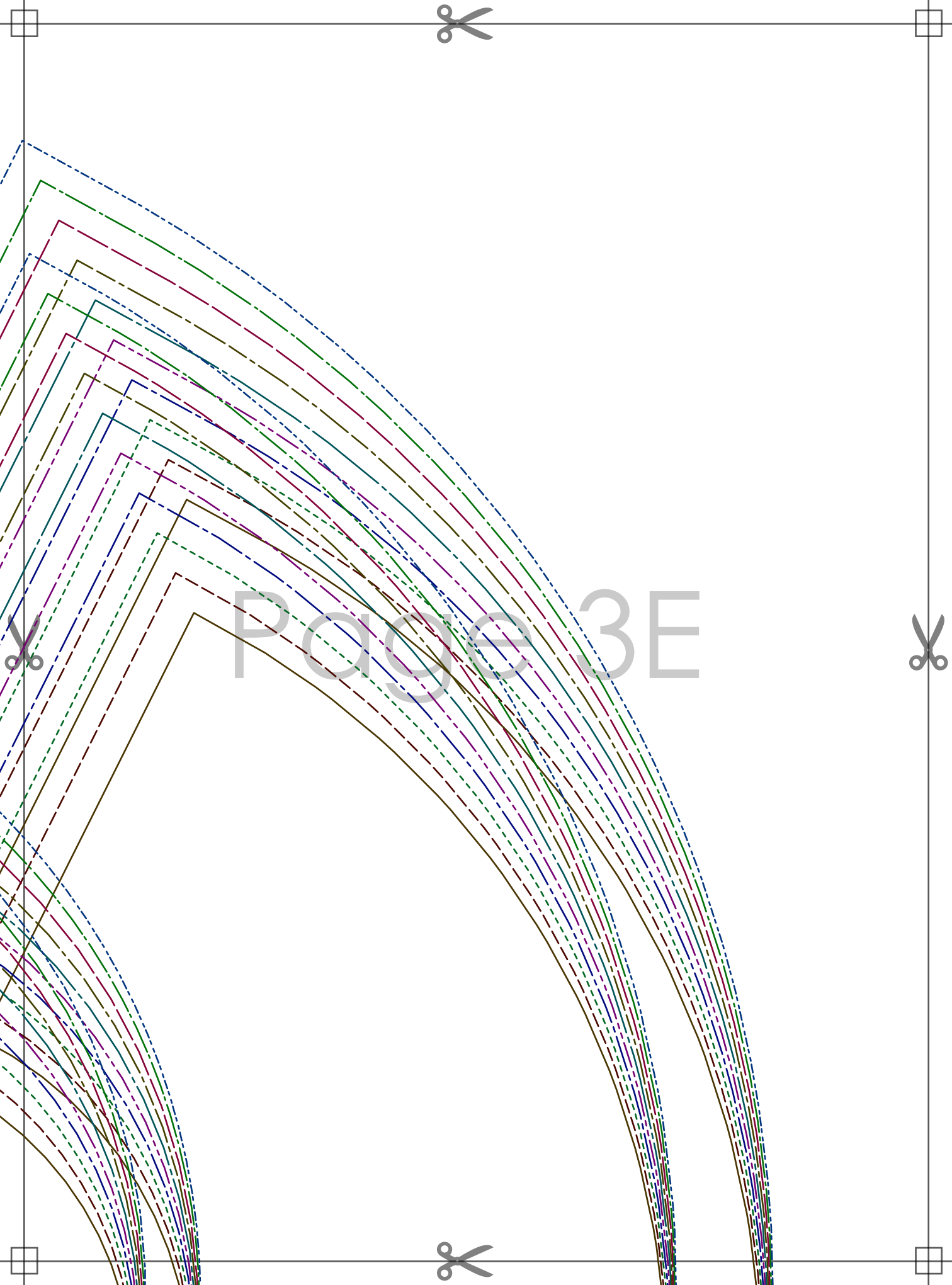

Page 3E



Tiana's  
*Closet*

**MILEY FLOUNCE HEM SKIRT**  
with seam allowance

**Size: *XXX***  
**BACK WAISTBAND**  
cut 4

Grainline

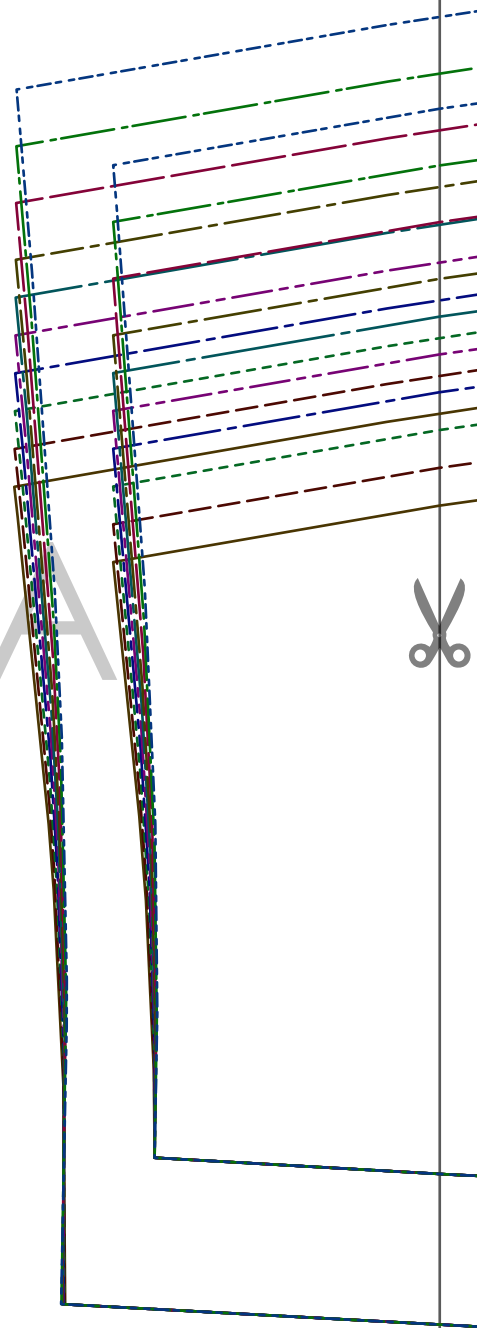
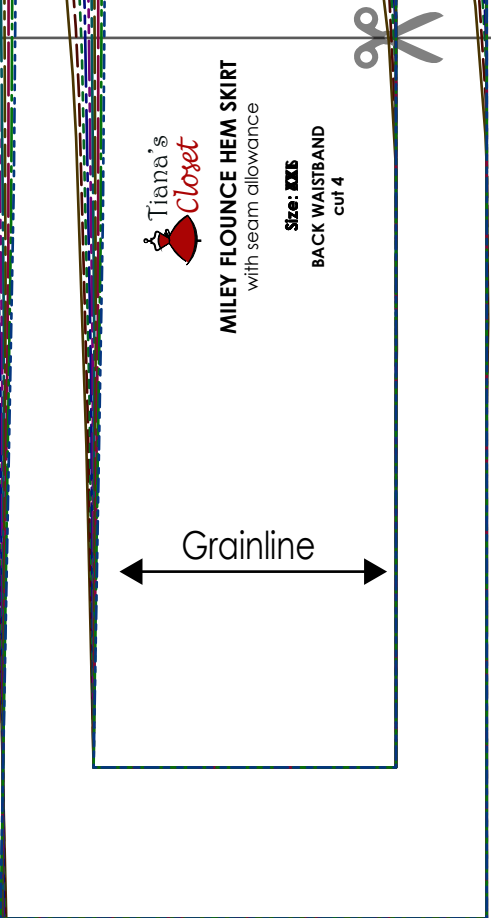
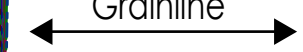

Page 4A



Page 43



Tiana's  
Closet

**MILEY FLOUNCE HEM SKIRT**  
with seam allowance

**Size: XXS**

**CENTER BACK**  
cut 2

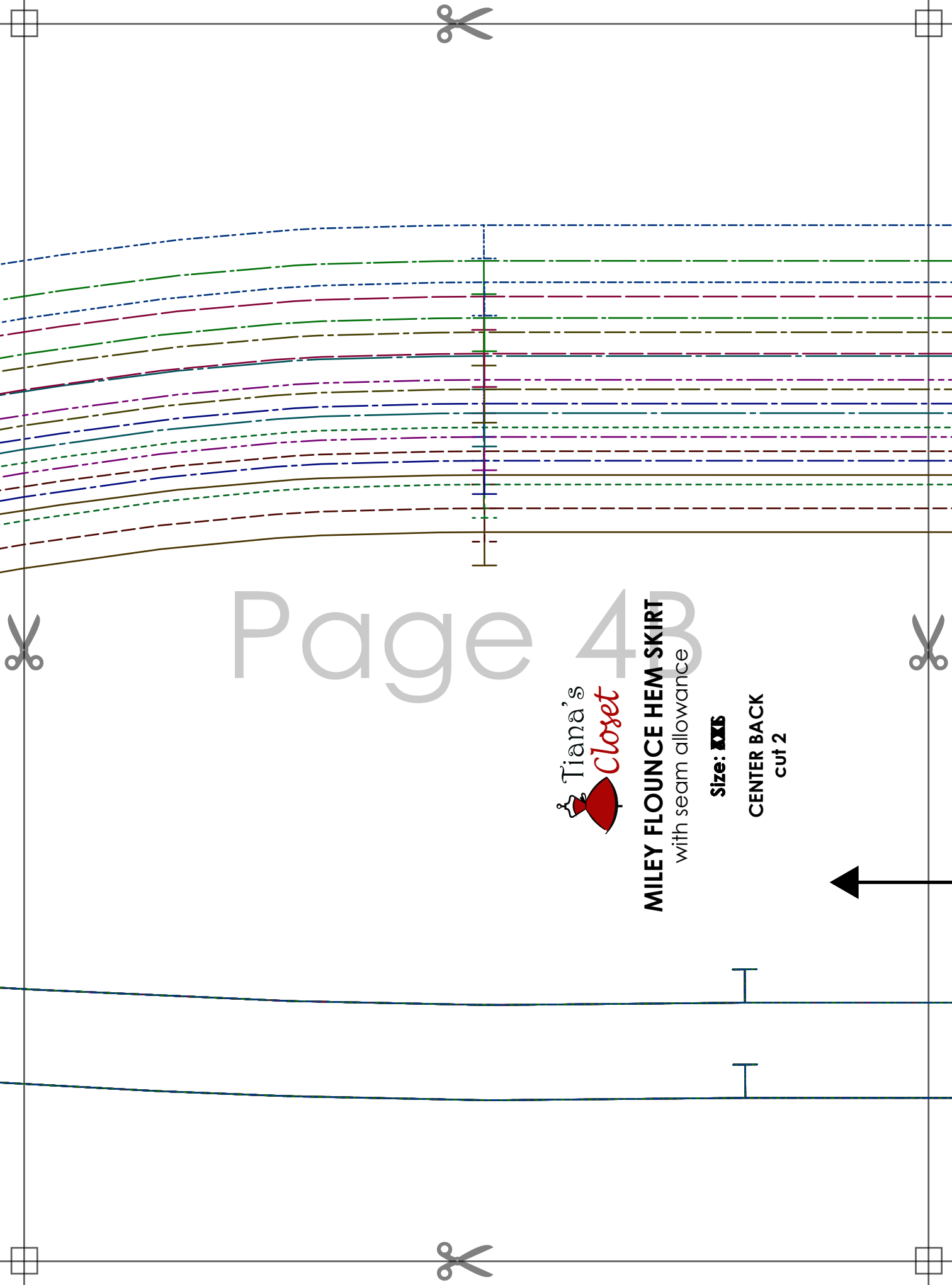

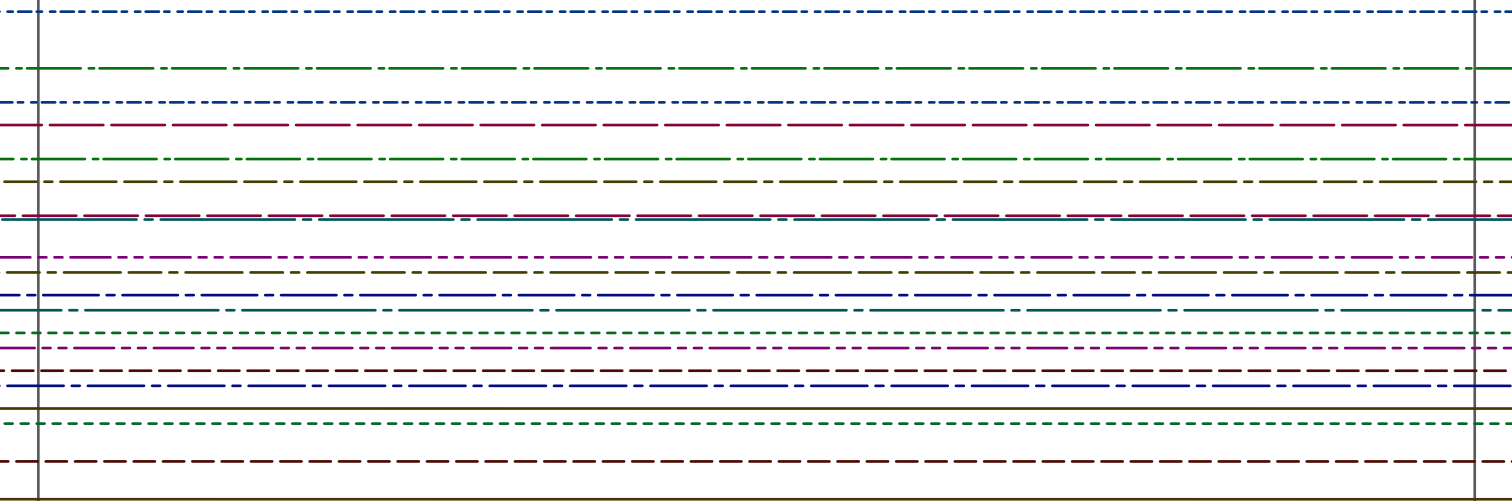

Page 4C



Grainline

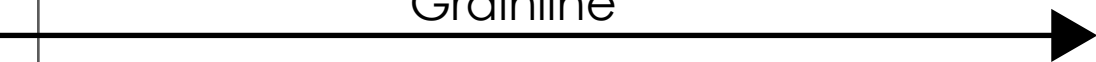

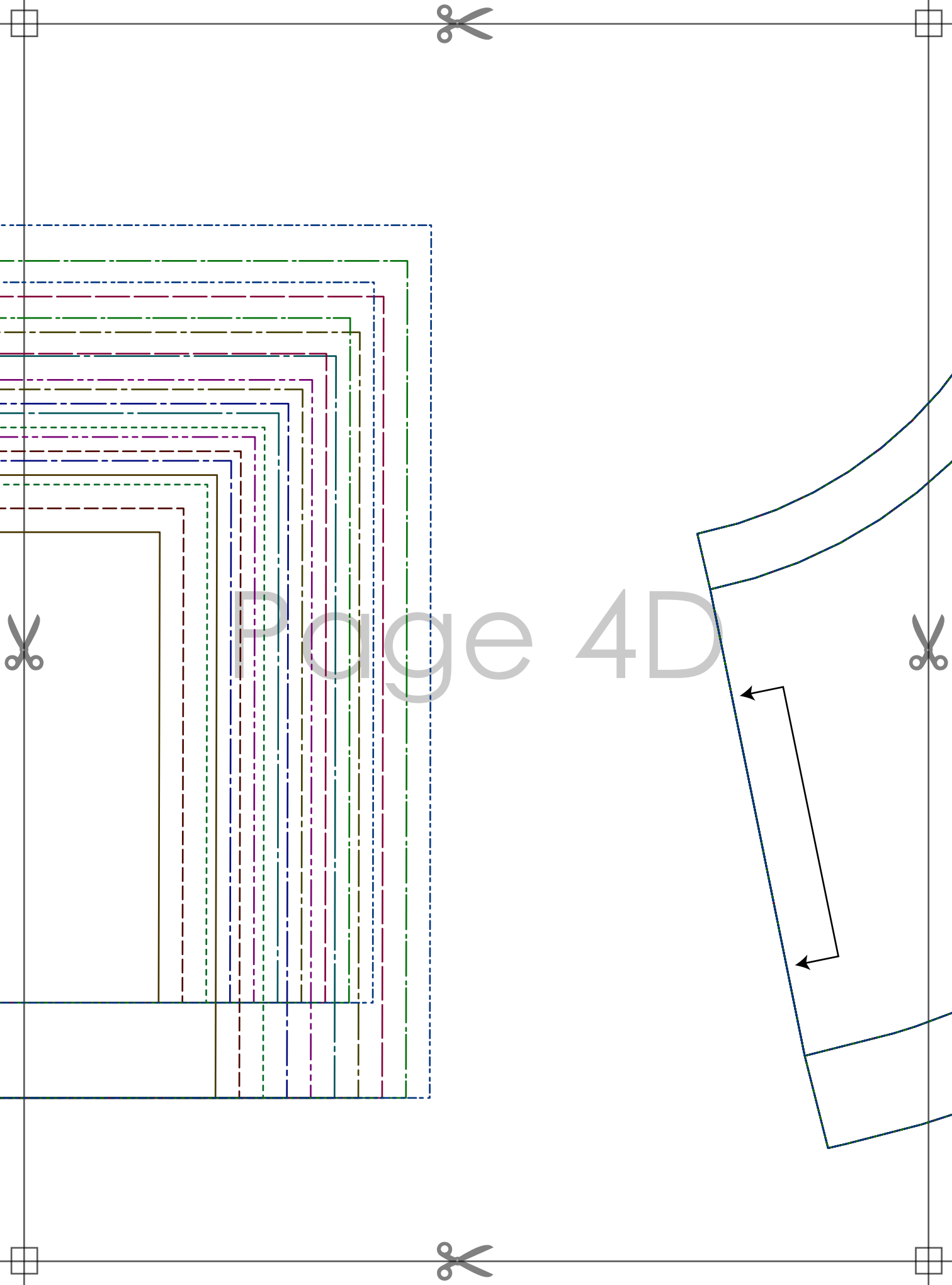



**MILEY FLOUNCE HEM SKIRT**  
with seam allowance

**Size: XXS**

**BACK FLOUNCE**  
cut 1 on fold

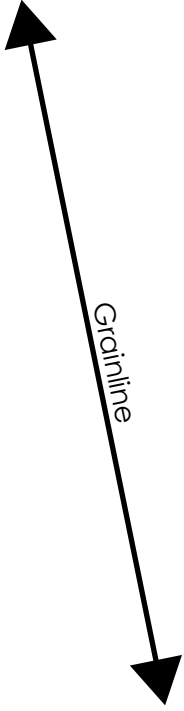

Page 4E