

Page 1A

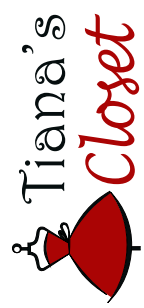

LISA SCALLOPED HEM SKIRT

with seam allowance

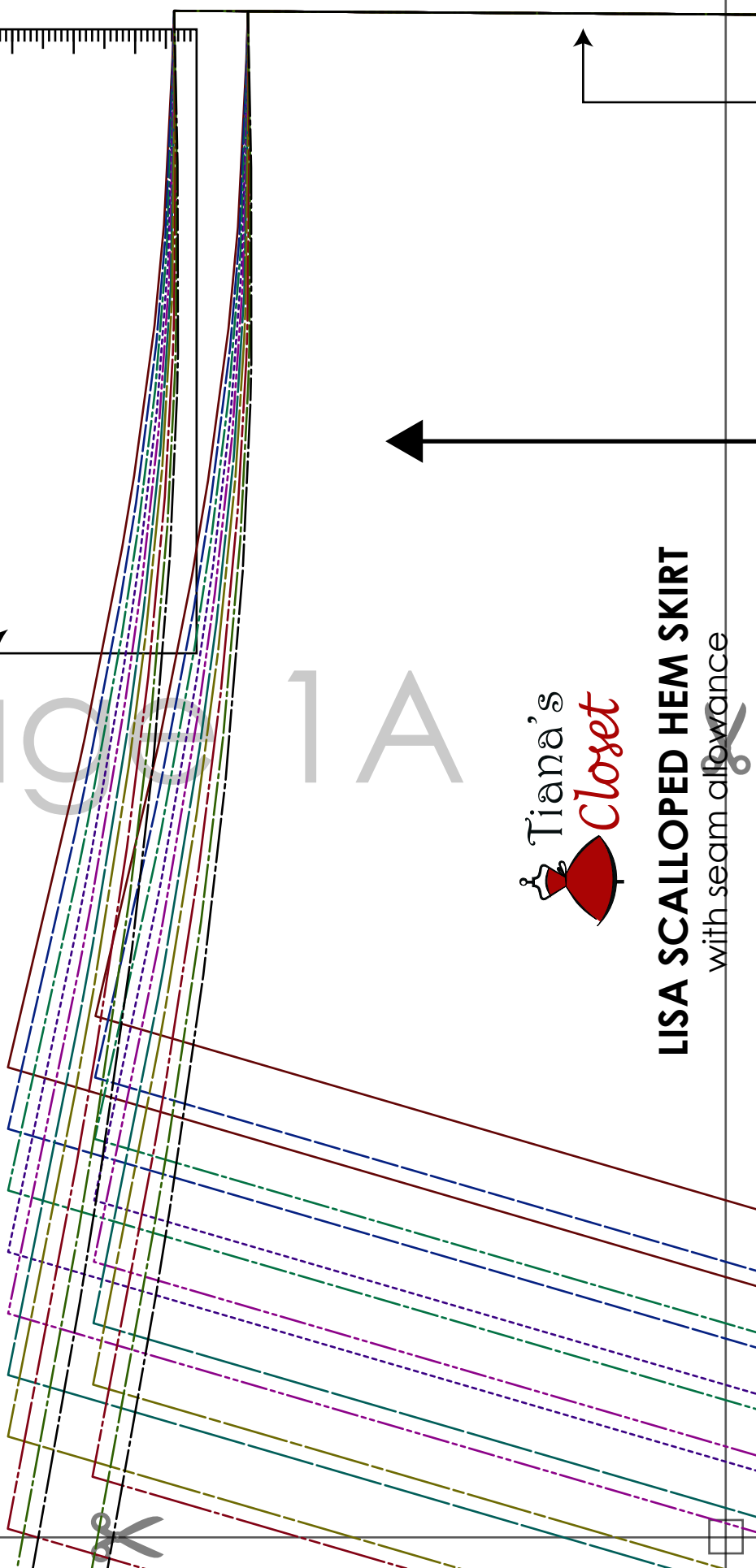
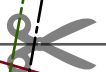

with seam allowance

Size: 165

FRONT - UPPER PART
cut 1 on fold

Grainline

Page 1 B

USA SCALLOPED HEM SKIRT
with seam allowance

Size: **XS**
FRONT WAISTBAND
cut 2 on fold

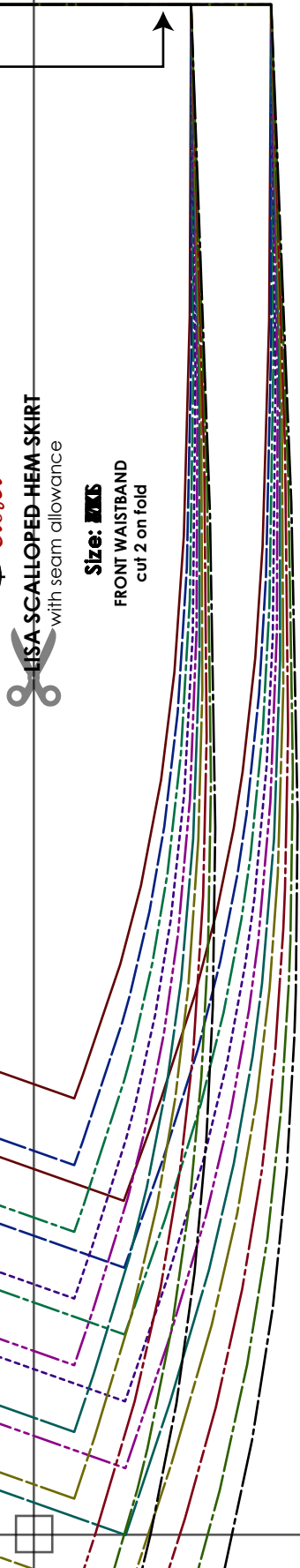

Page 1C

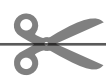
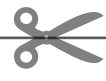



Page 1D

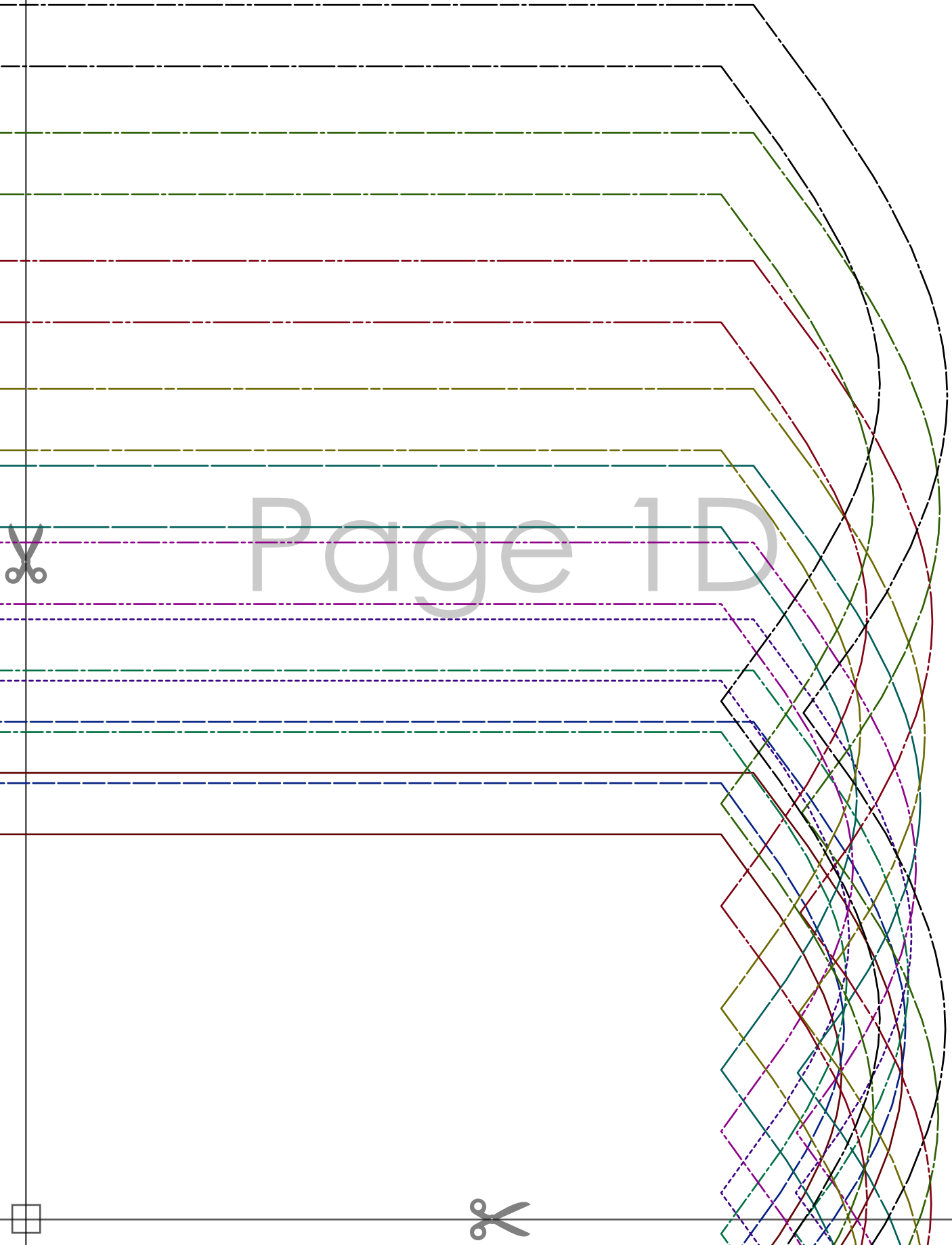

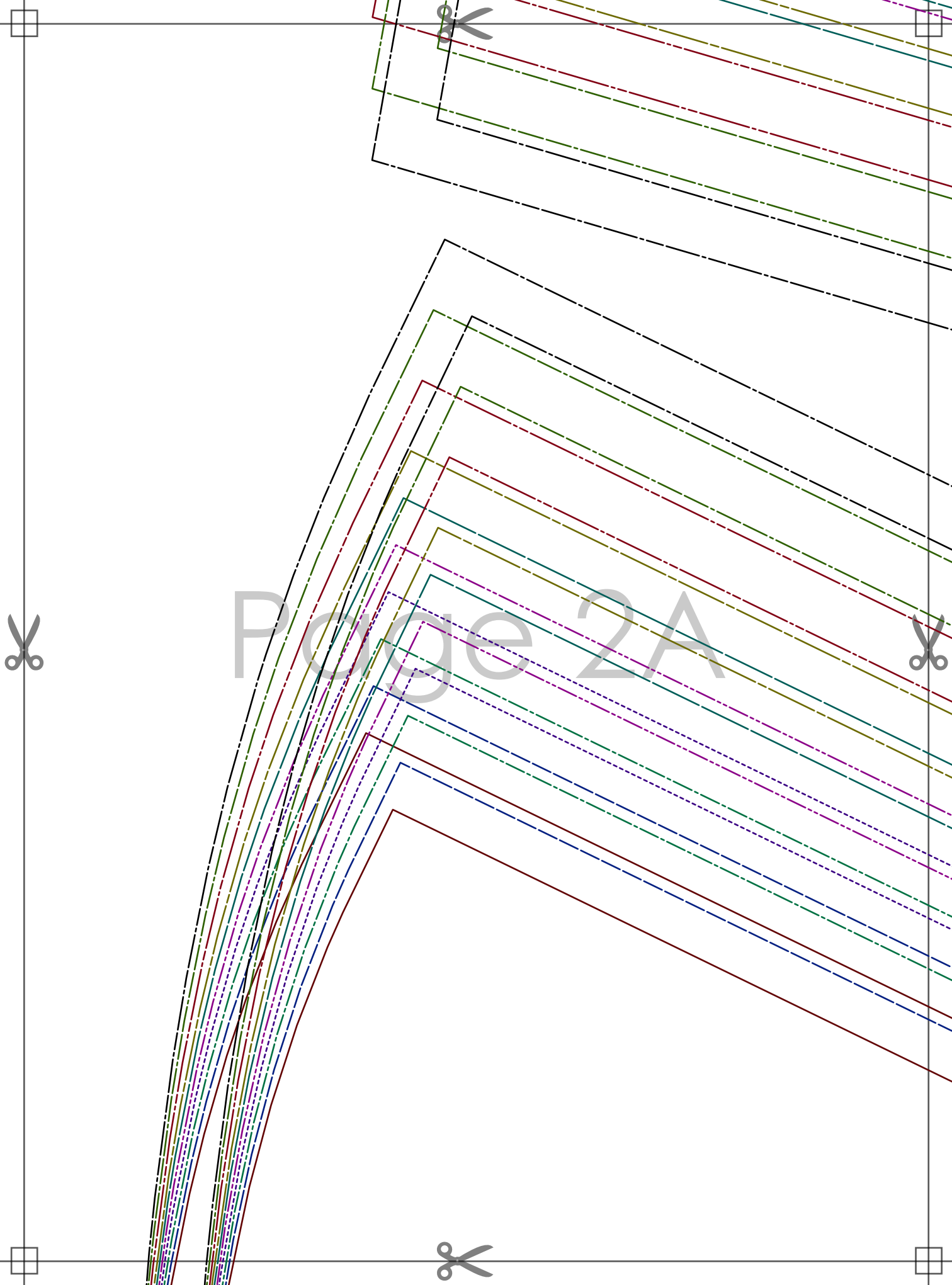

Page 2A

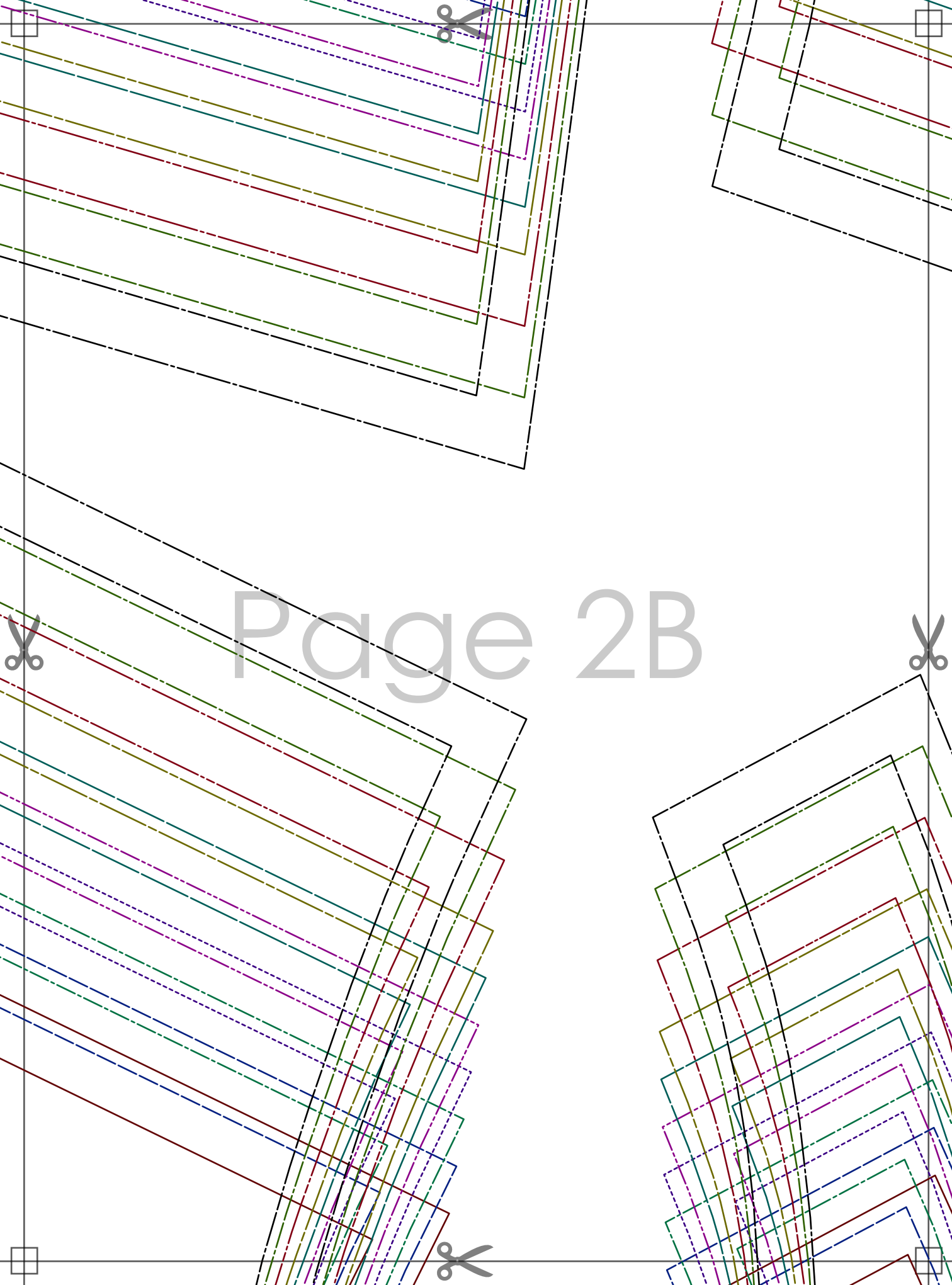

Page 2B

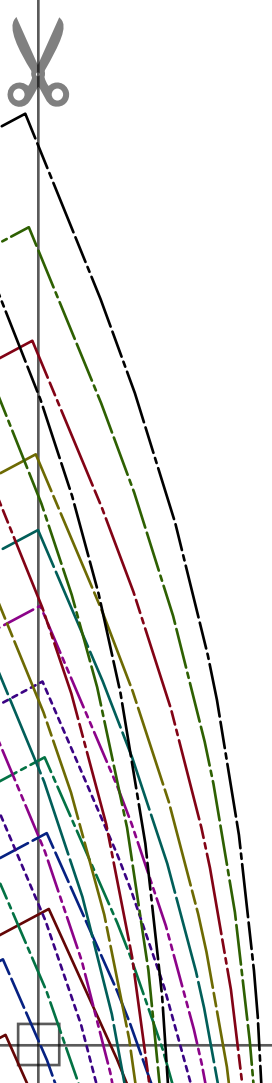
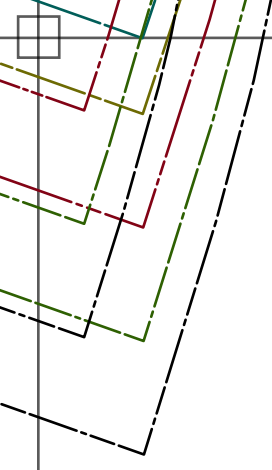

Page 2C

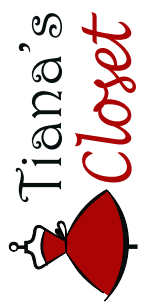

LISA SCALLOPED HEM SKIRT
with seam allowance

with seam allowance

Size: **A6**

LOWER PART
cut 2 on fold

Page 2D

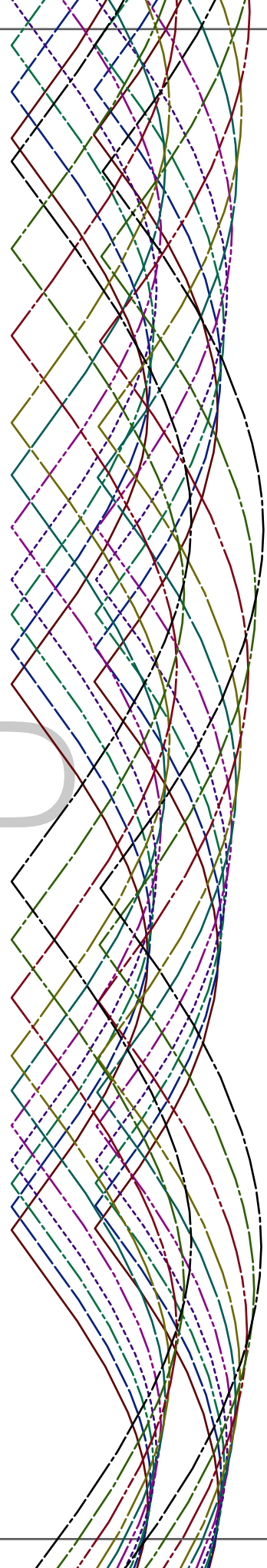



LISA SCALLOPED HEM SKIRT

with seam allowance

Size: **MKS**

BACK - UPPER PART
cut 2

Grainline

Page 3A

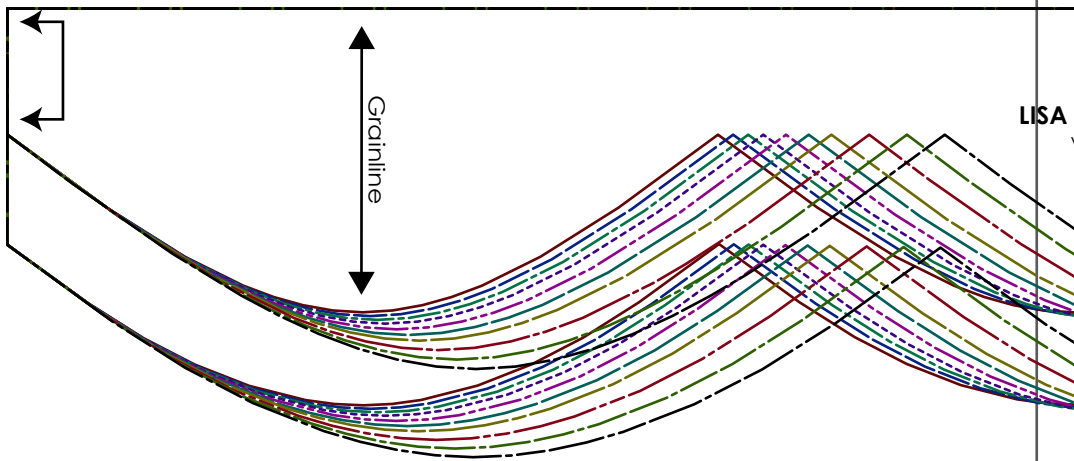
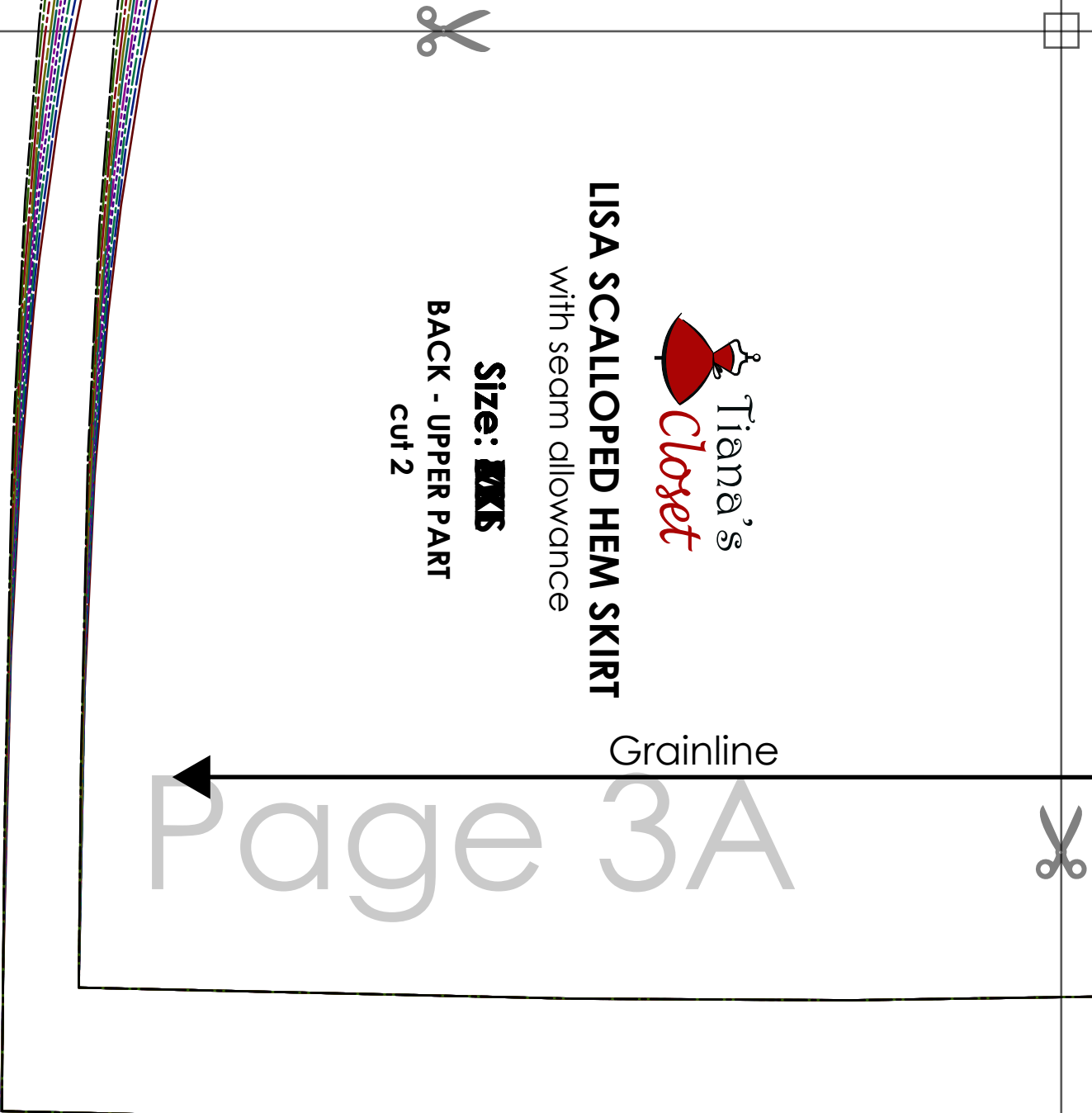

LISA

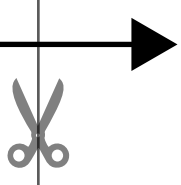

Page 3B



LISA SCALLOPED HEM SKIRT
with seam allowance

Size: **MKB**



Grainline



LISA SCALLOPED HEM SKIRT
with seam allowance

Size: **MKB**
HEMLINE FACING
cut 2 on fold

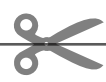
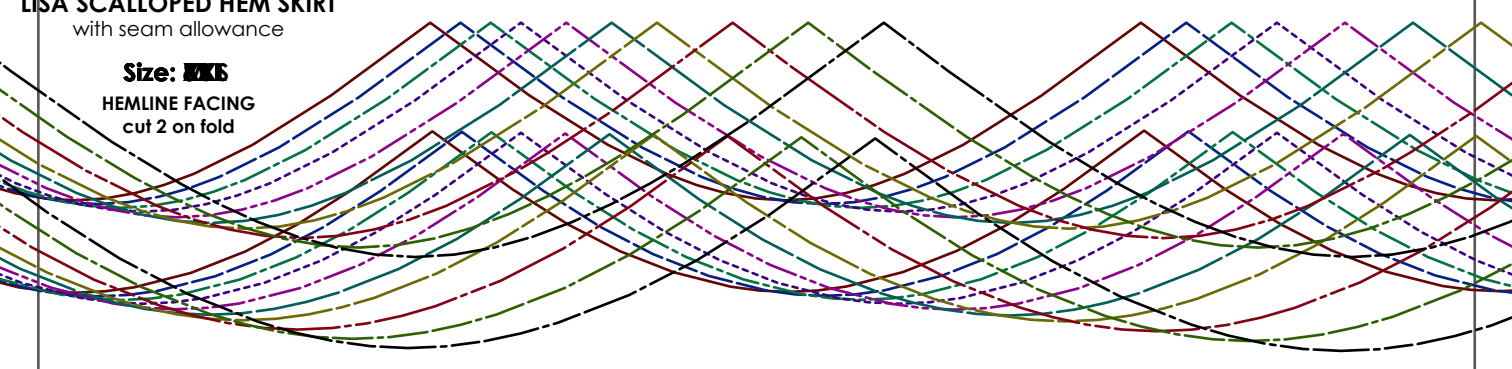

LISA SCALLOPED TIEBAND SKIRT
with seam allowance

Size: **7/8**
BACK WAISTBAND
cut 4

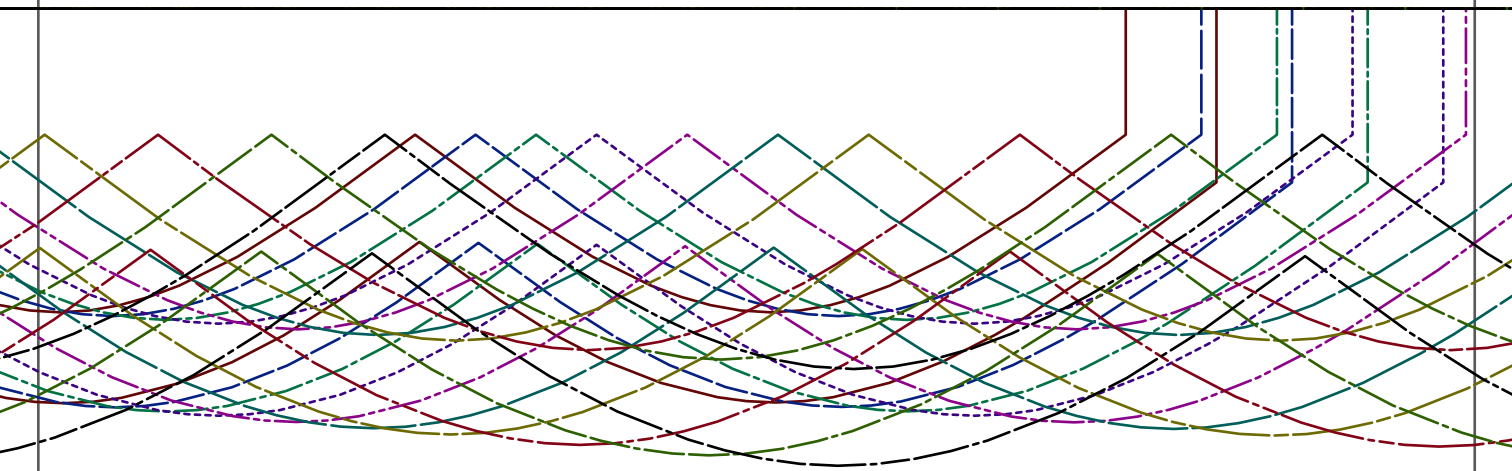
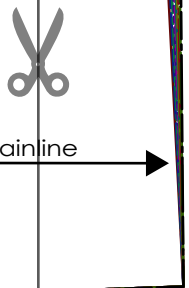

Page 3C

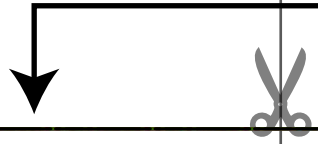
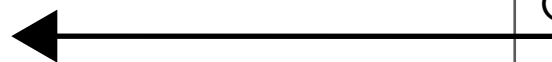

Grainline

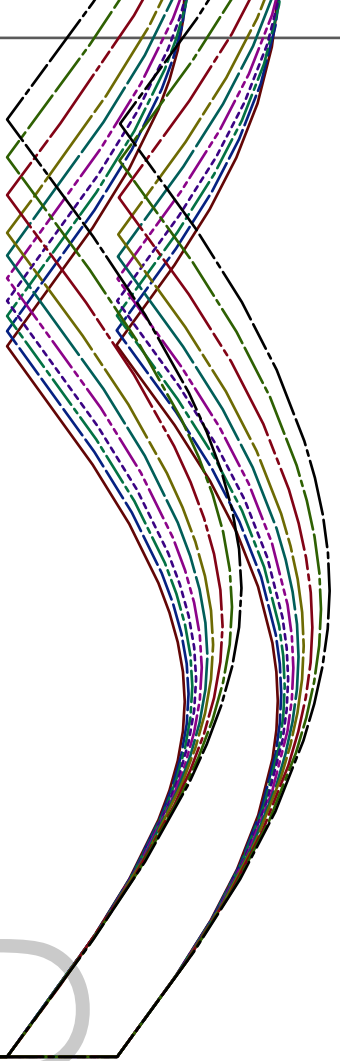

Page 3D

