

Page 1A

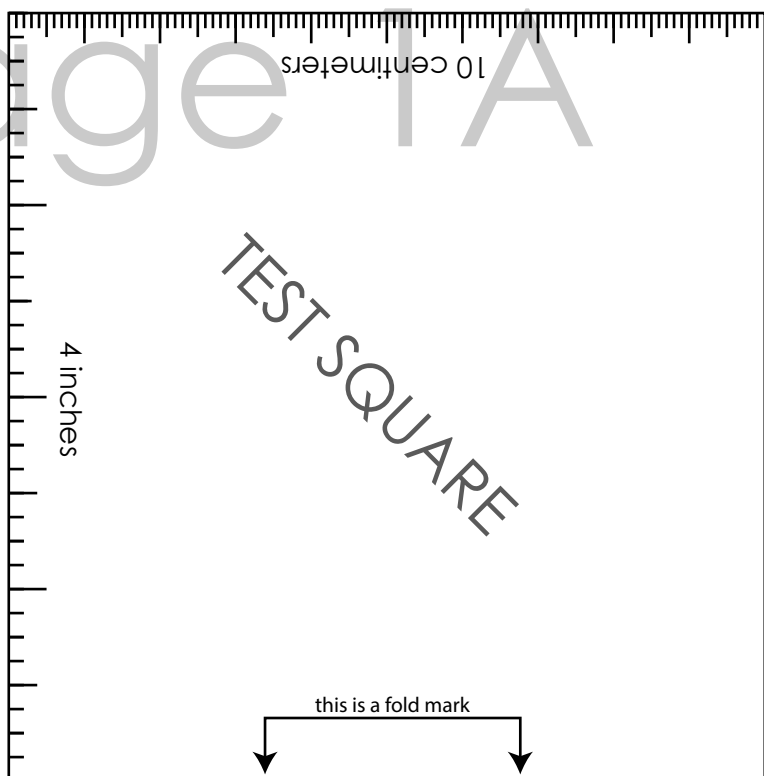



## DEVON DRESS

with seam allowance  
REGULAR SIZE RANGE

**Size: ~~M~~S**

**SLEEVE  
cut 2**

Page 1 B

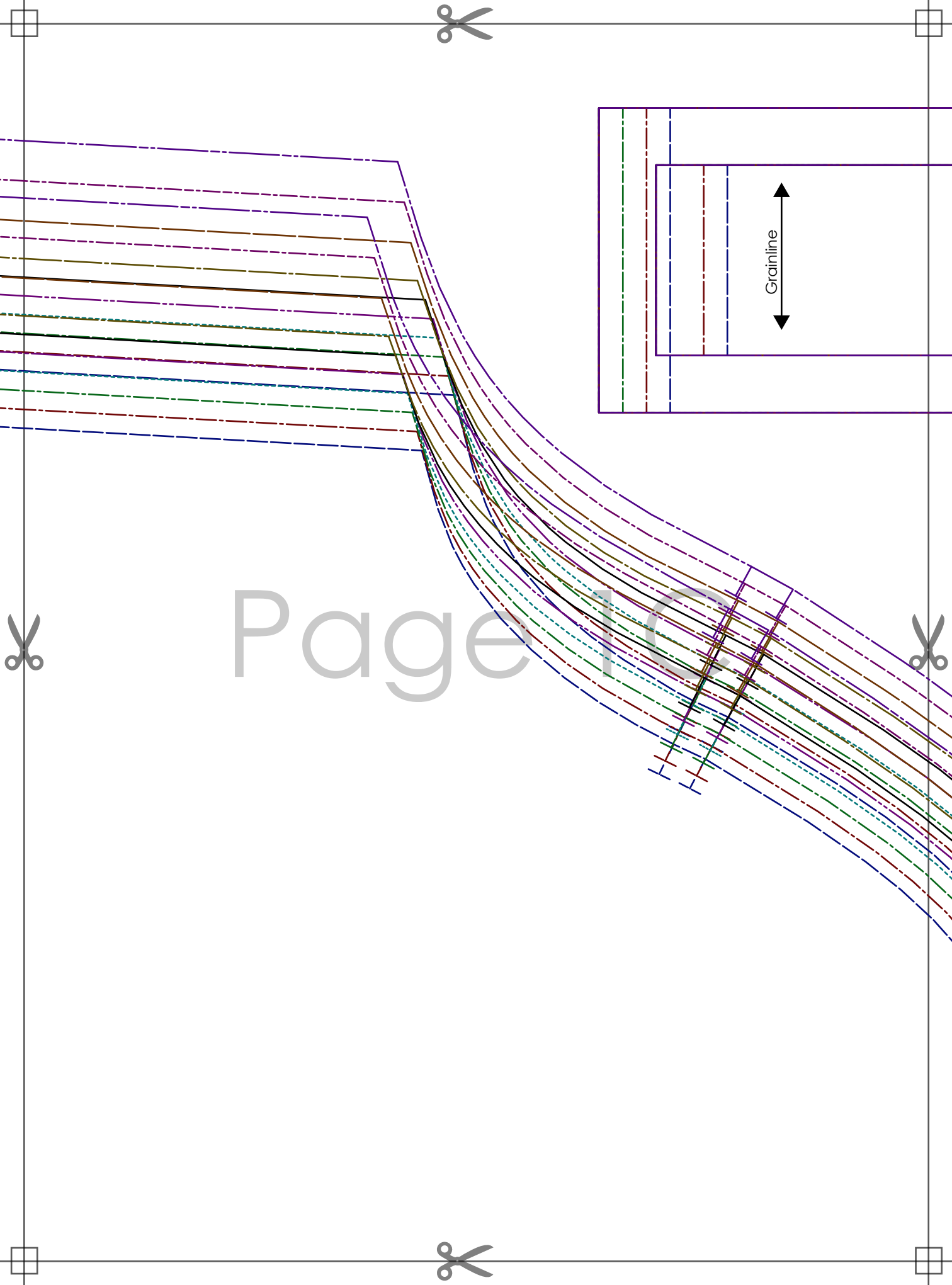



Tiana's  
*Closet*

**DEVON DRESS**

with seam allowance  
REGULAR SIZE RANGE

**Size: XS**

**SLEEVE CUFF**  
cut 4

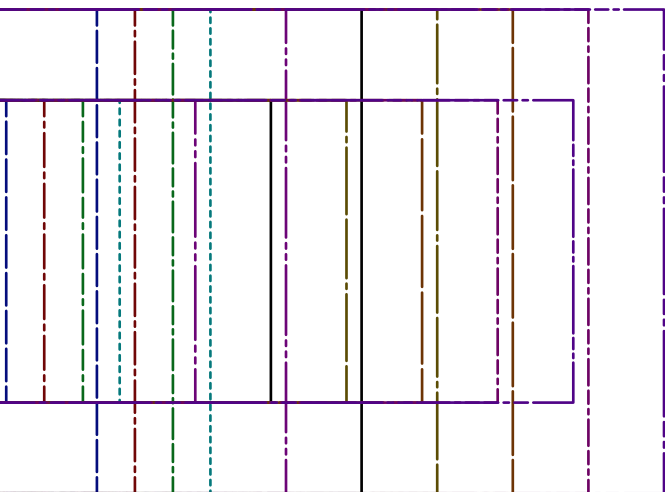

Page 1D

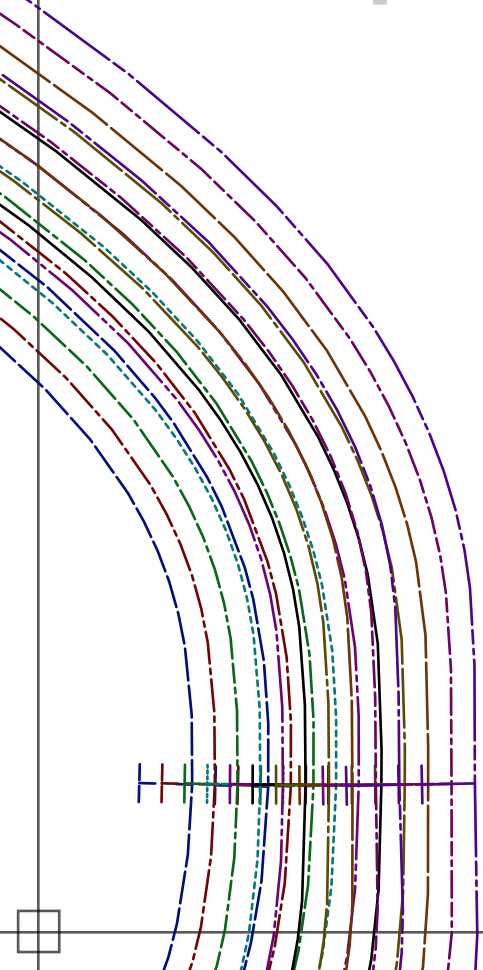



Page 2A

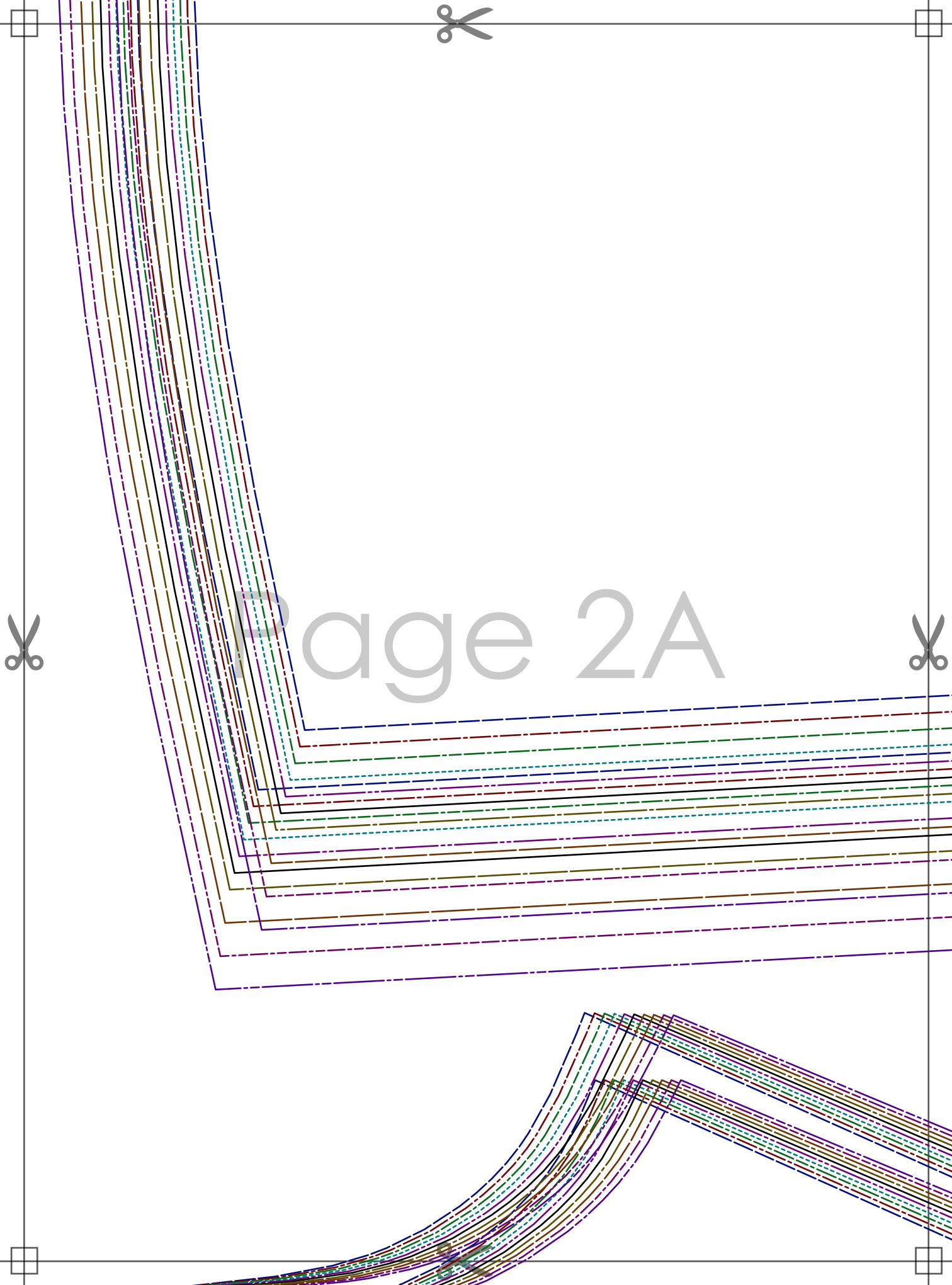

Grainlin

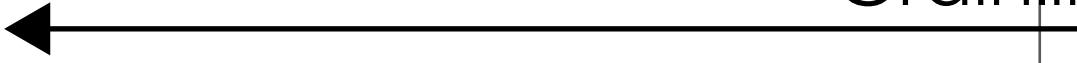

Page 2B

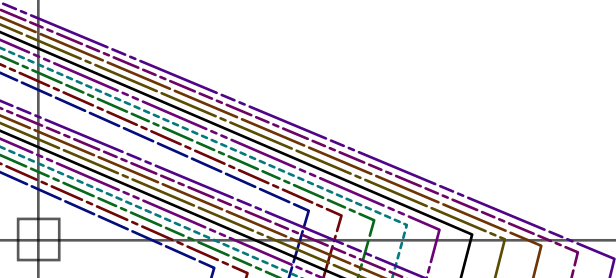

online

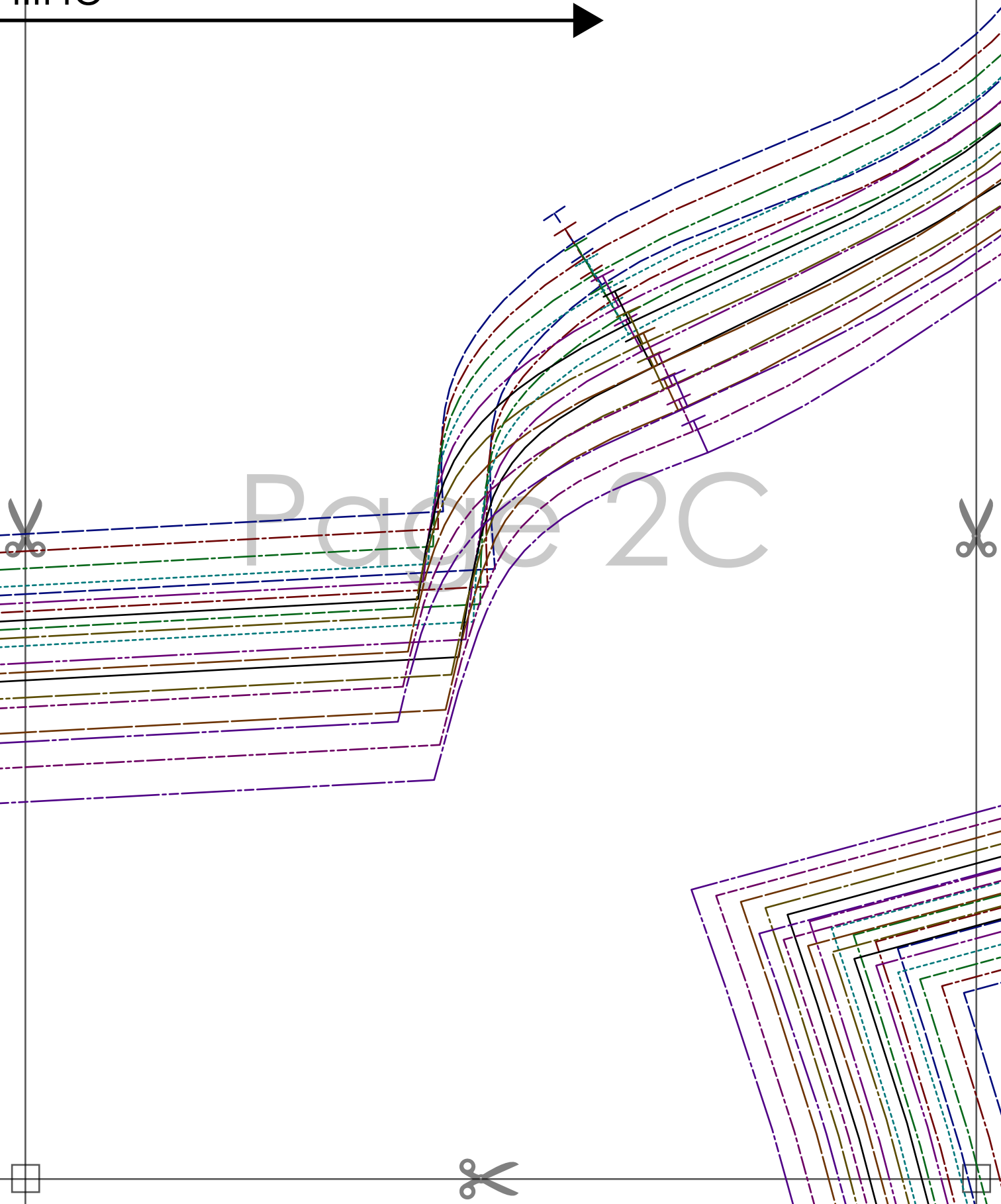
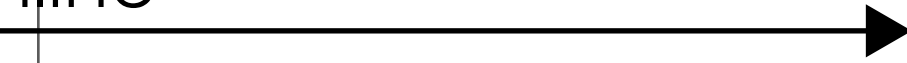

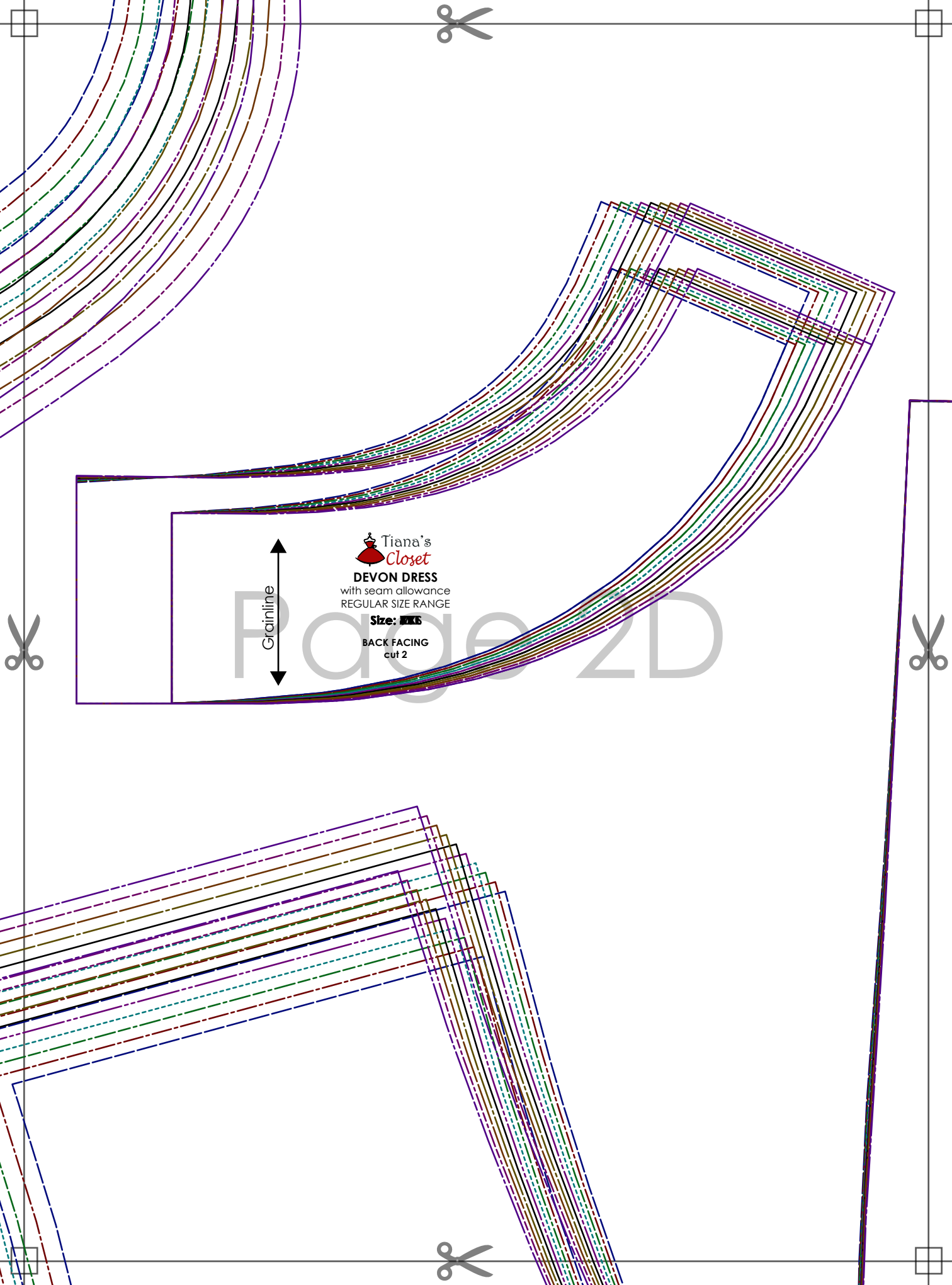

Grainline



Tiana's  
*Closet*  
**DEVON DRESS**  
with seam allowance  
REGULAR SIZE RANGE

**Size: XXXS**

**BACK FACING  
cut 2**

Page 2D



Page 2E



**DEVON DRESS**

with seam allowance  
REGULAR SIZE RANGE

**Size: ~~XS~~ S**

**BACK SKIRT - UPPER TIER**  
cut 2

Grainline

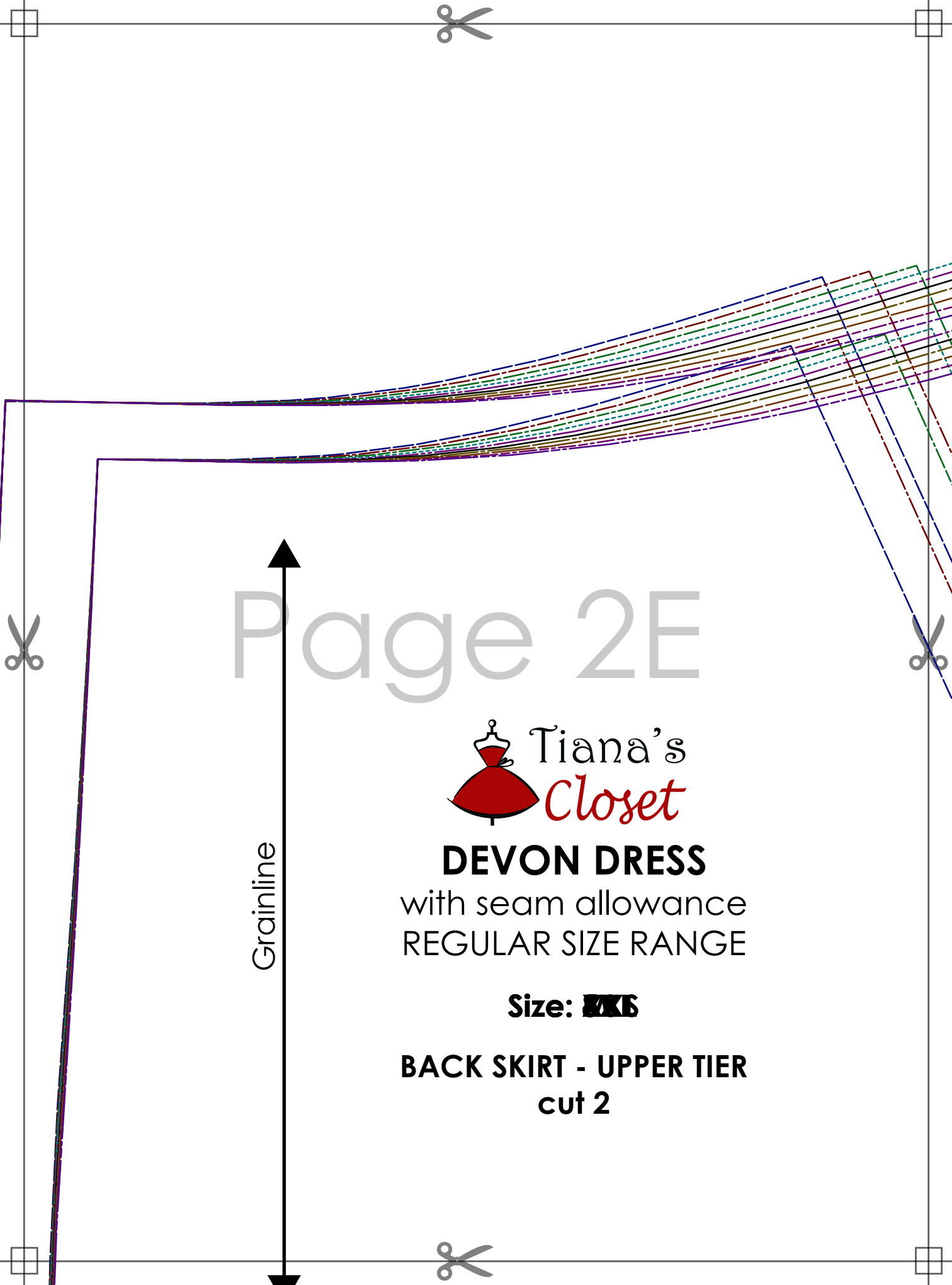

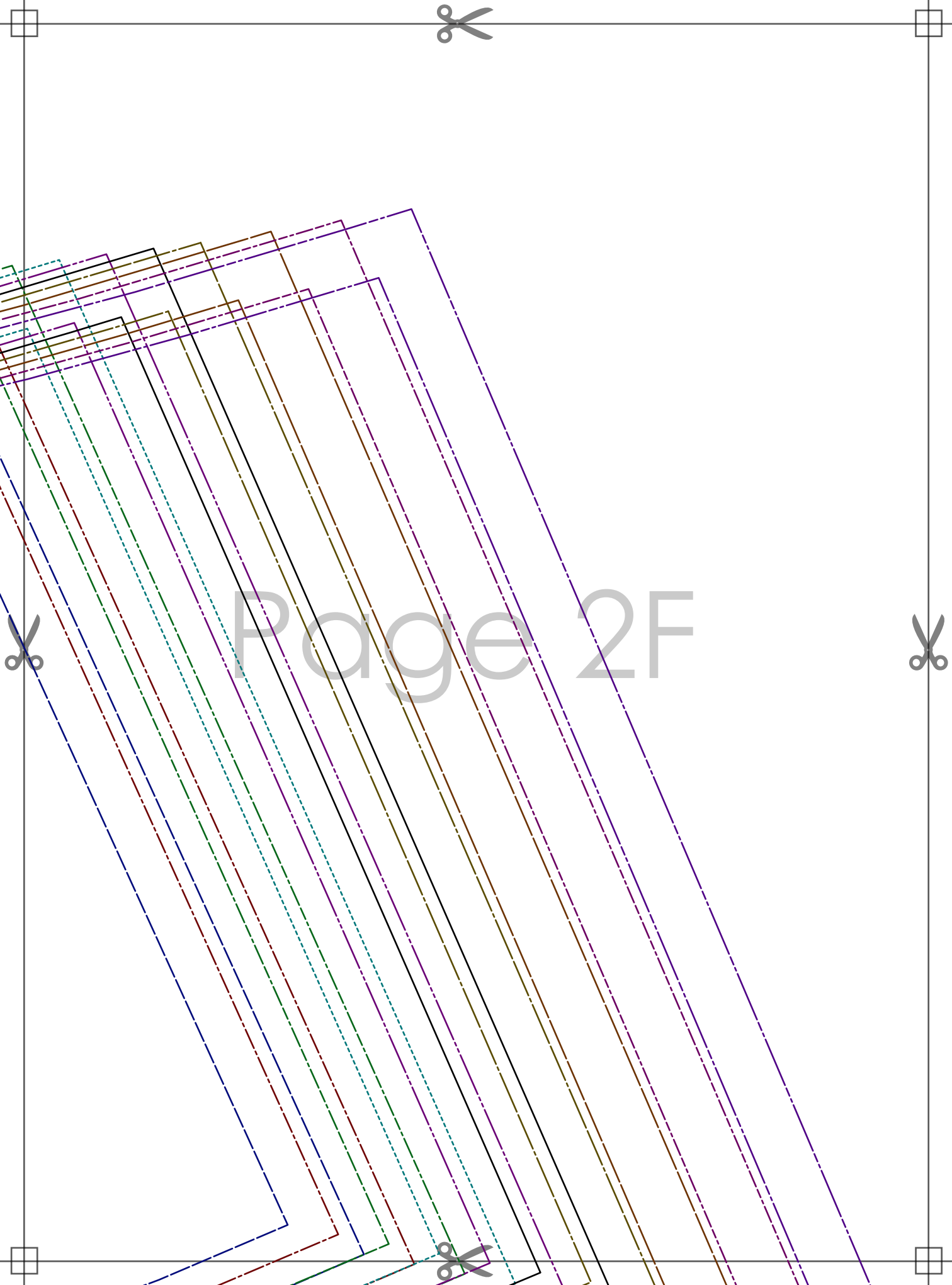

Page 2F

Page 3A



**DEVON DRESS**

with seam allowance  
REGULAR SIZE RANGE

**Size: ~~MKS~~**

**BACK  
cut 2**

Grainline



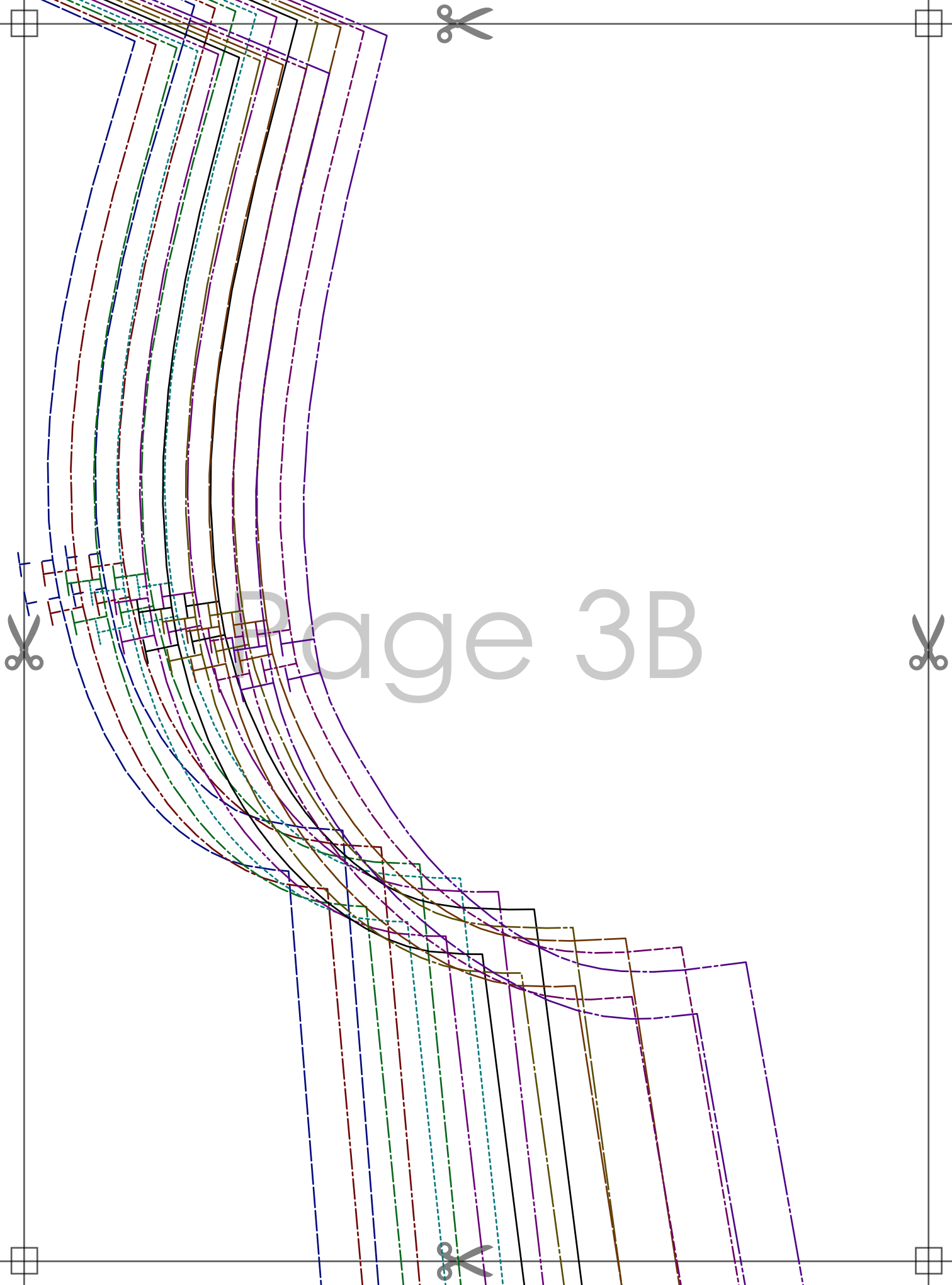

Page 3B

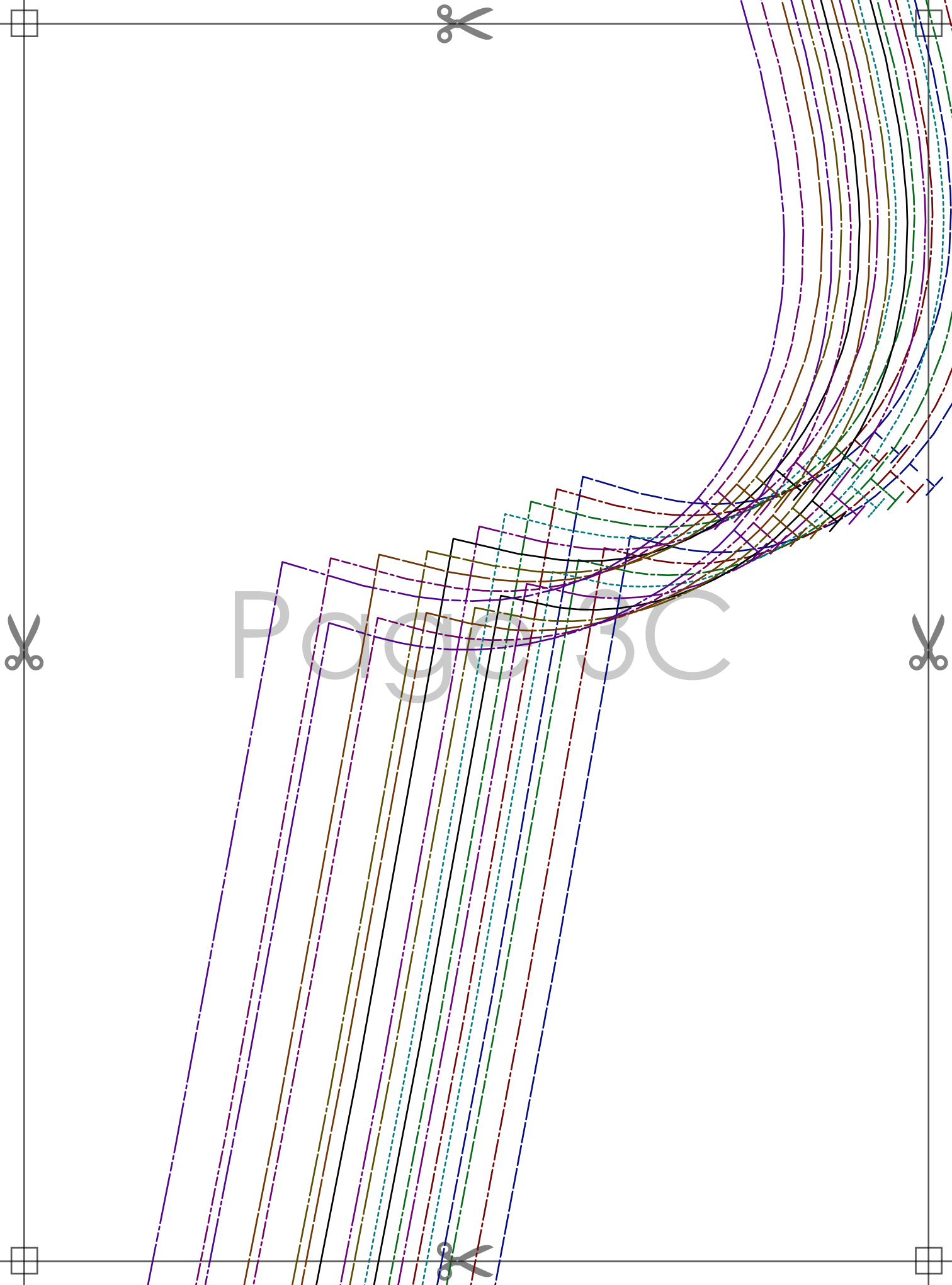

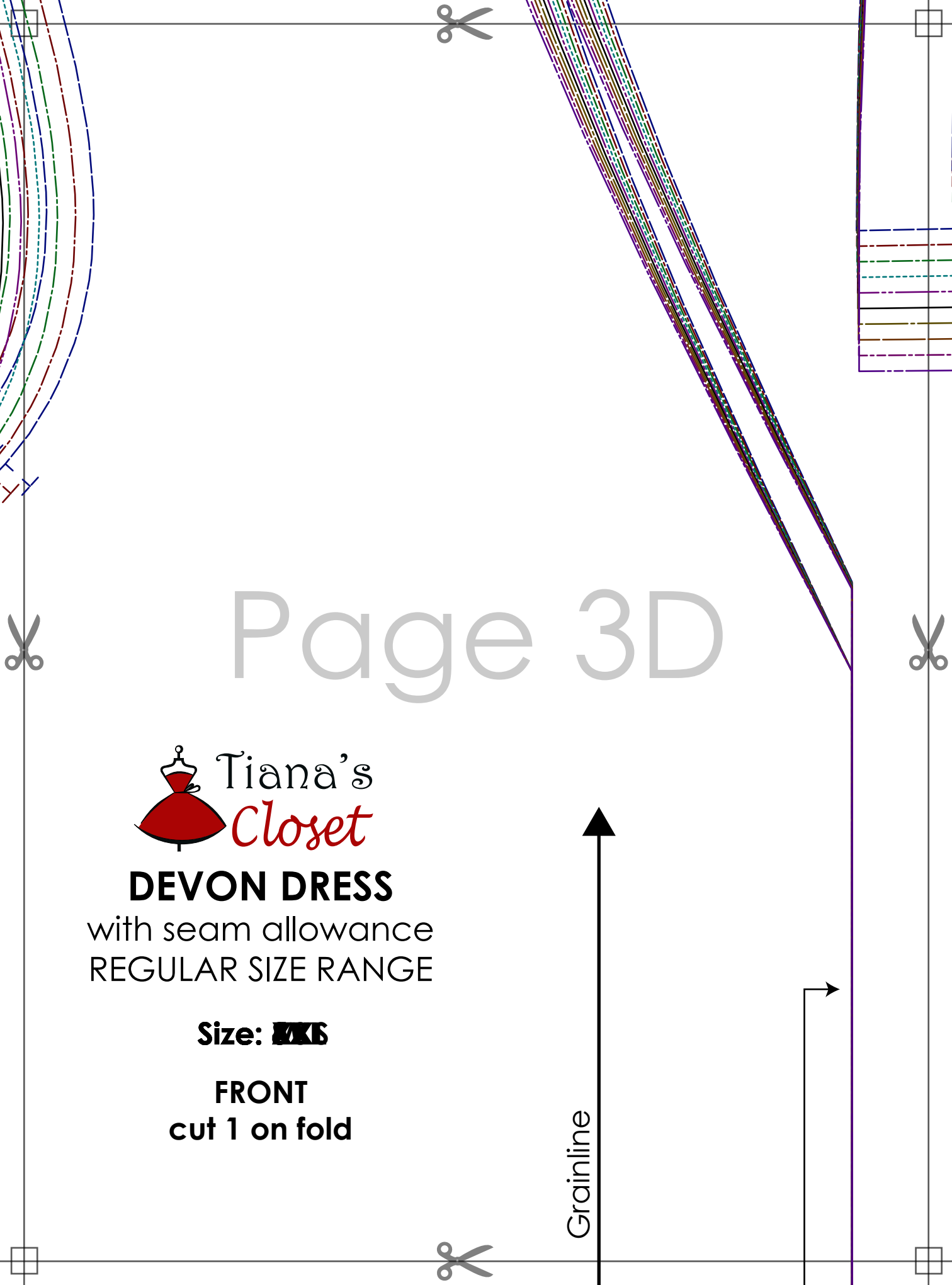

# Page 3D



Tiana's  
*Closet*

## DEVON DRESS

with seam allowance  
REGULAR SIZE RANGE

Size: ~~XS~~ XS

**FRONT**  
cut 1 on fold

Grainline

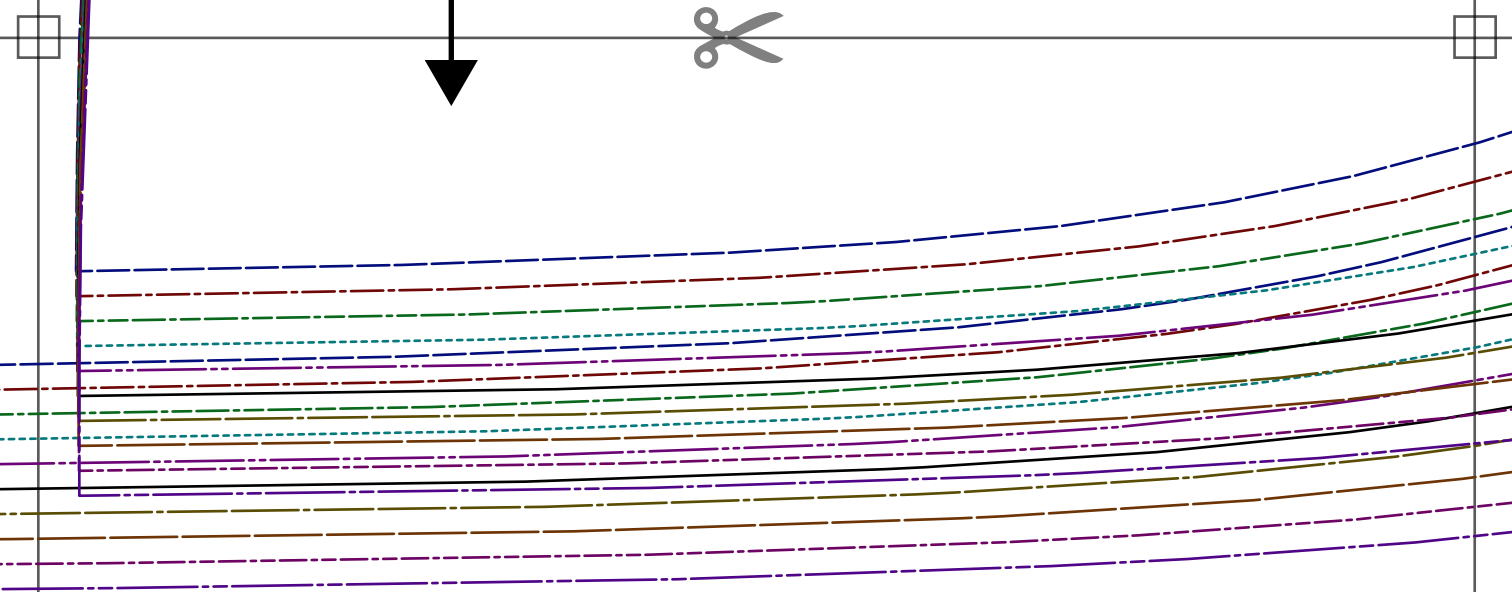

Page 3E

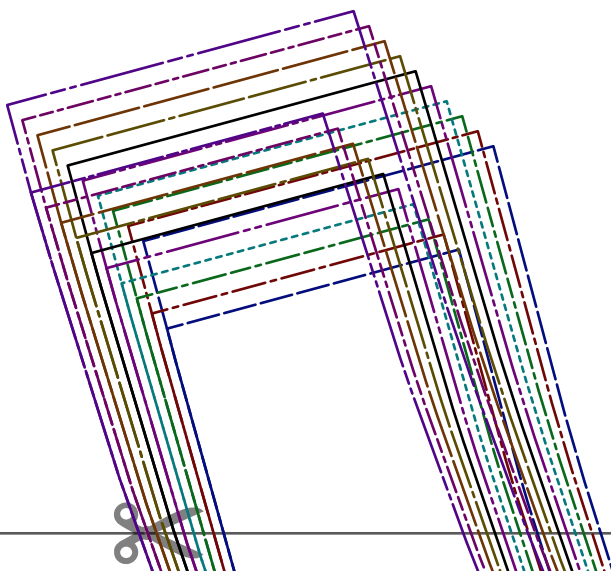

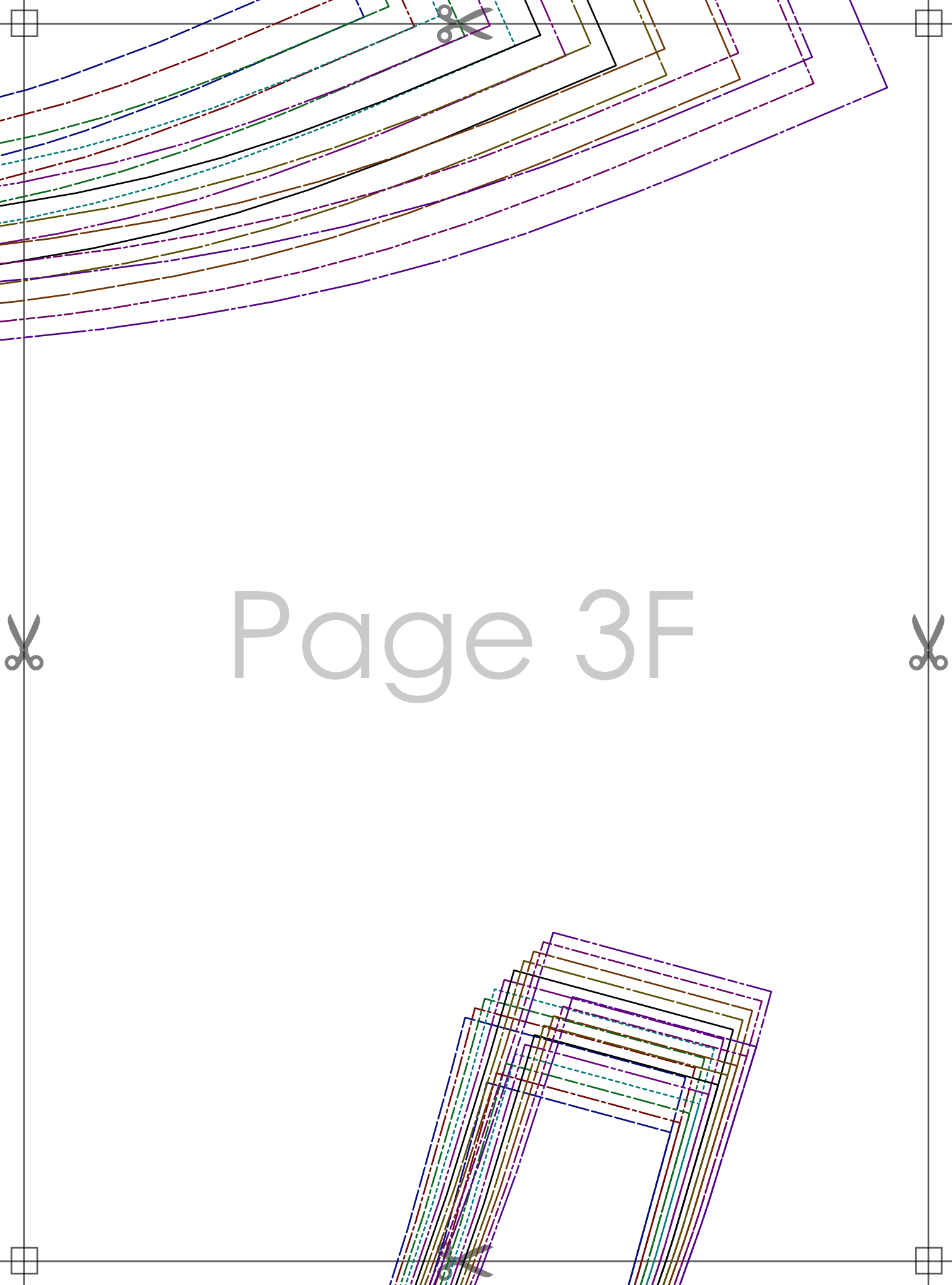

Page 3F





Page 4A



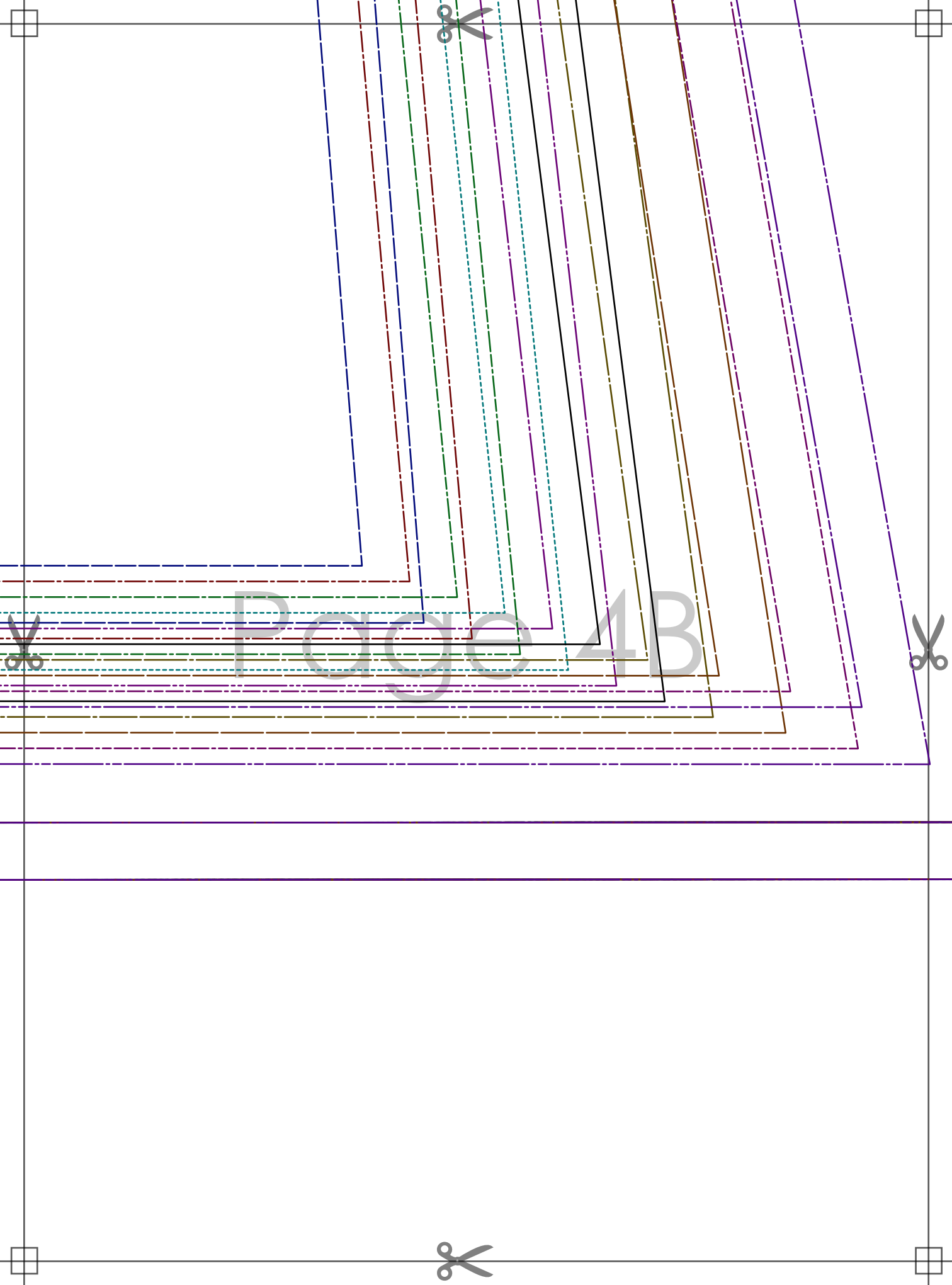

Page 4B

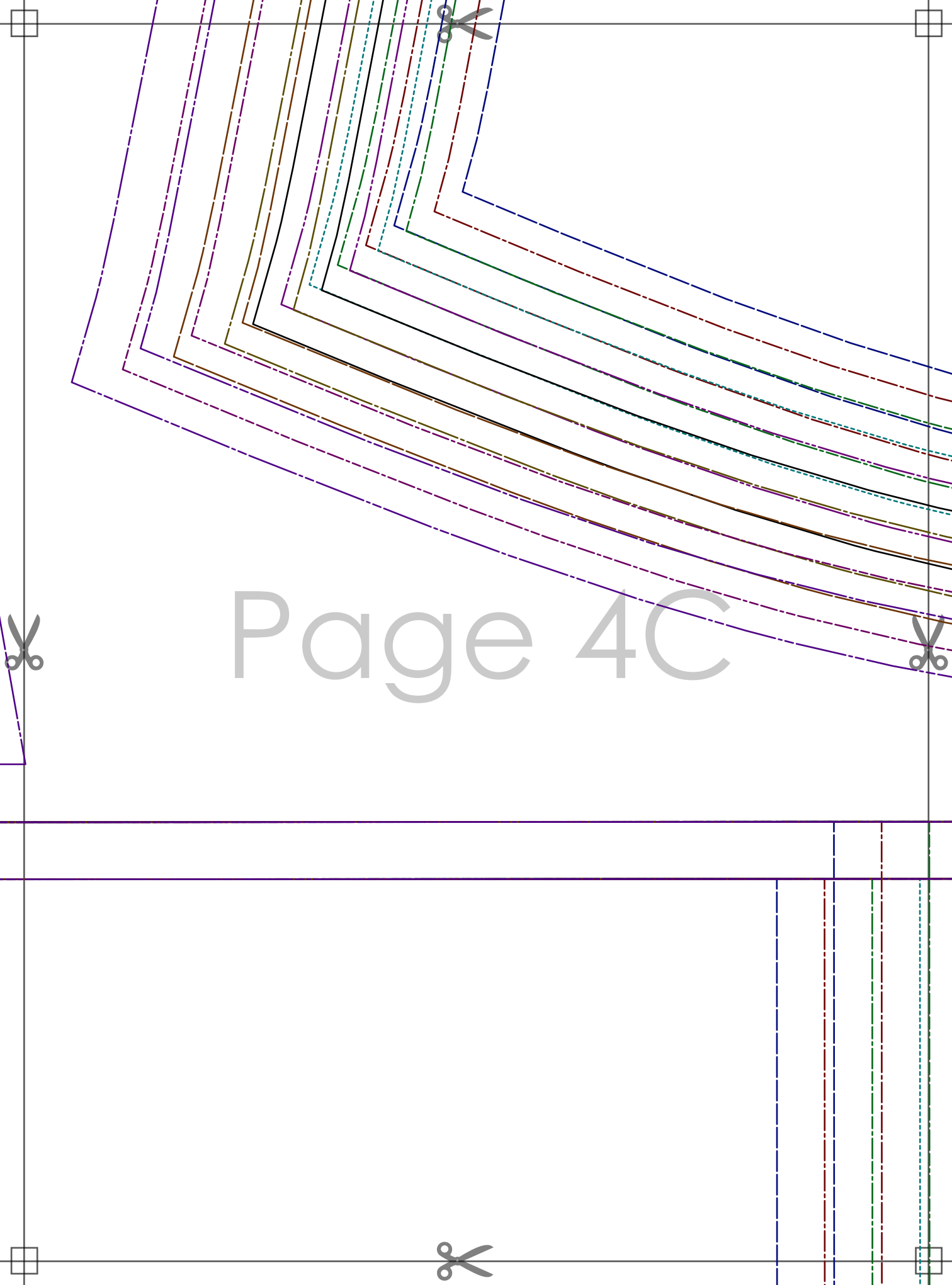

Page 4C

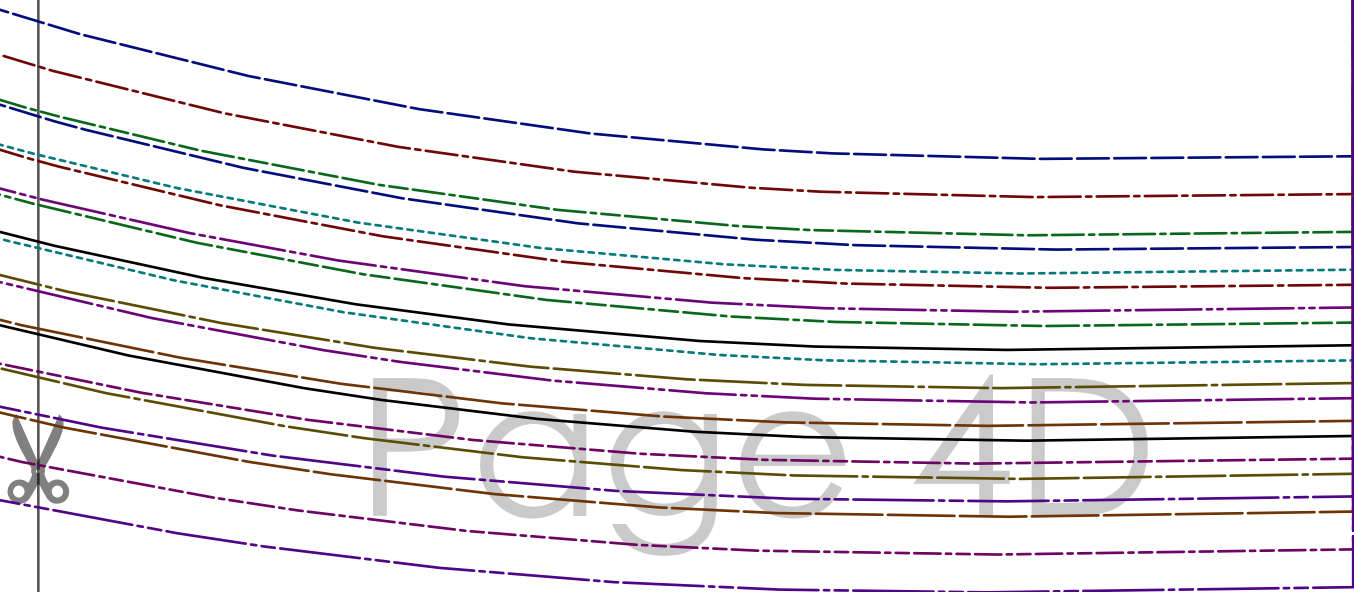
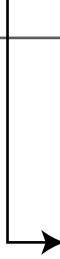

Page 4D

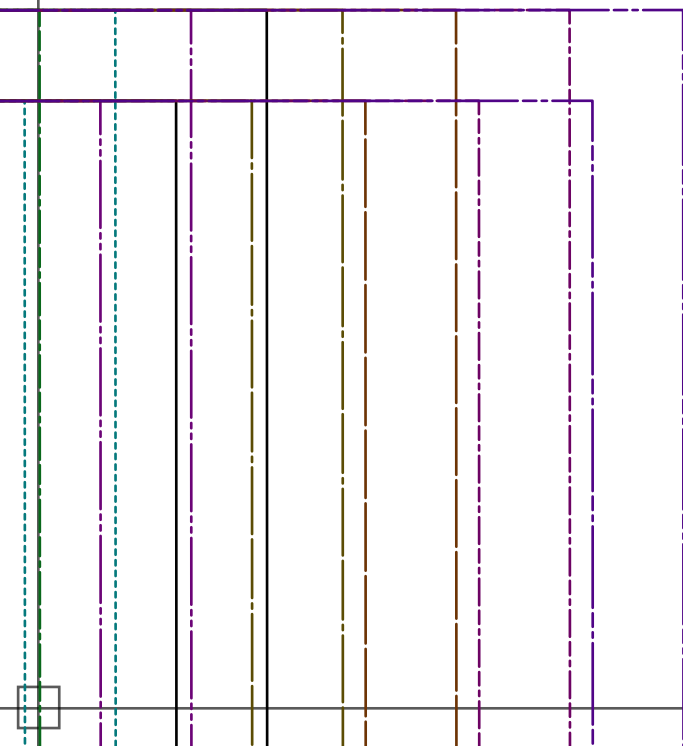

Page 4E

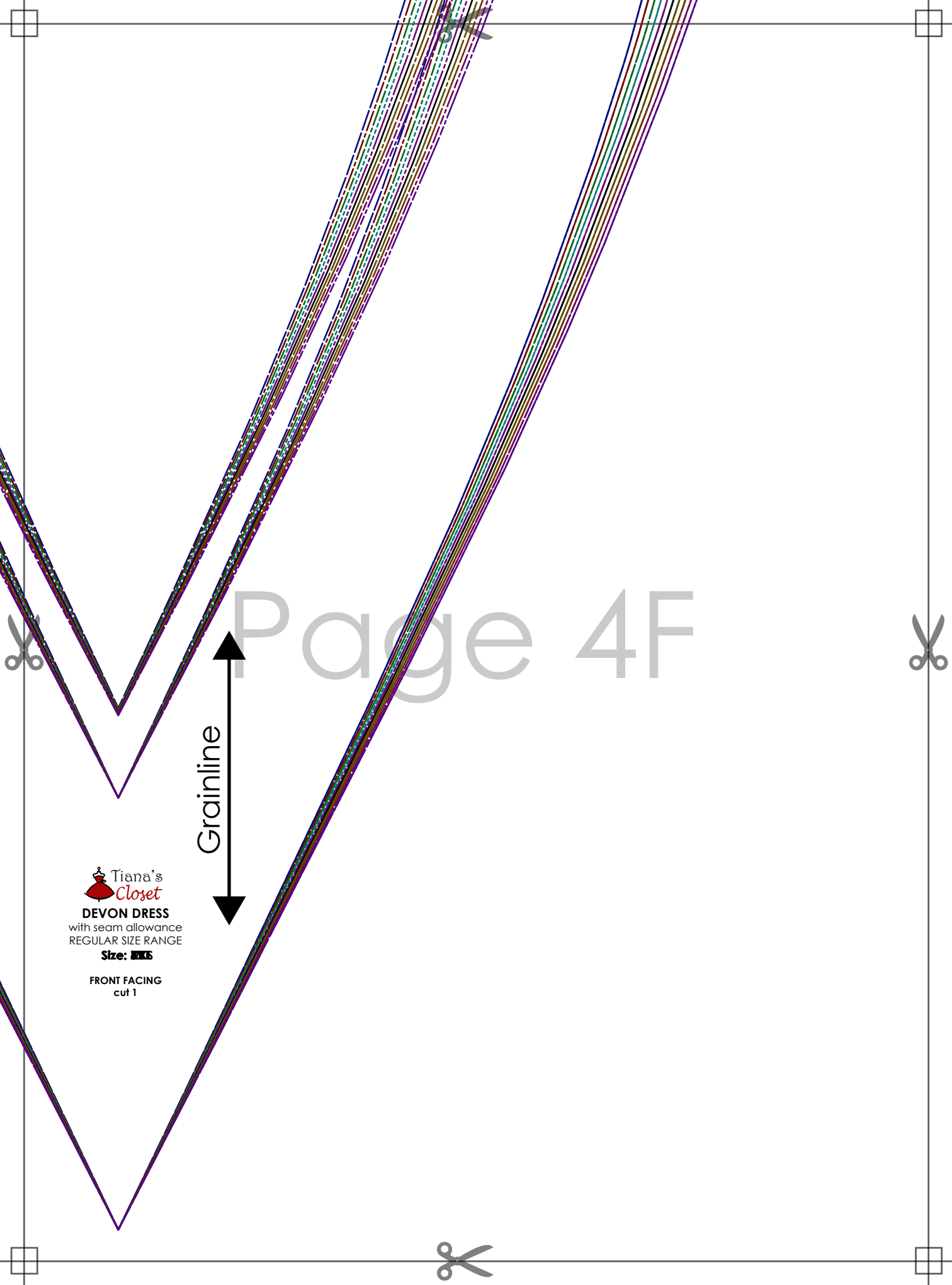

Page 4F

Grainline



Tiana's Closet

DEVON DRESS

with seam allowance  
REGULAR SIZE RANGE

Size: **XS**

FRONT FACING  
cut 1

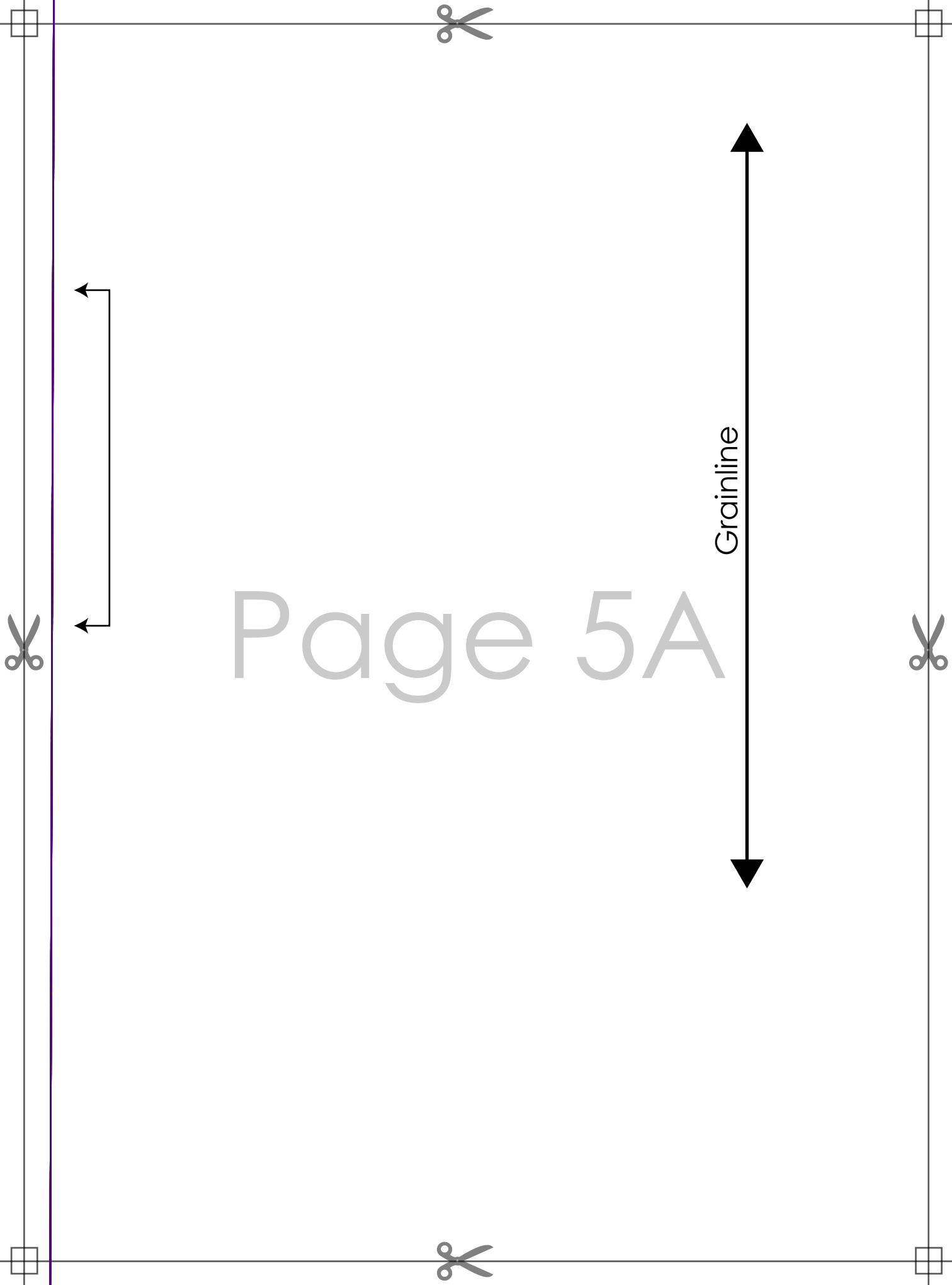

Page 5A

Grainline



## **DEVON DRESS**

with seam allowance  
REGULAR SIZE RANGE

**Size: ~~XS~~**

**SKIRT - MIDDLE TIER**  
**cut 2 on fold (1 back + 1 front)**

Page 5B



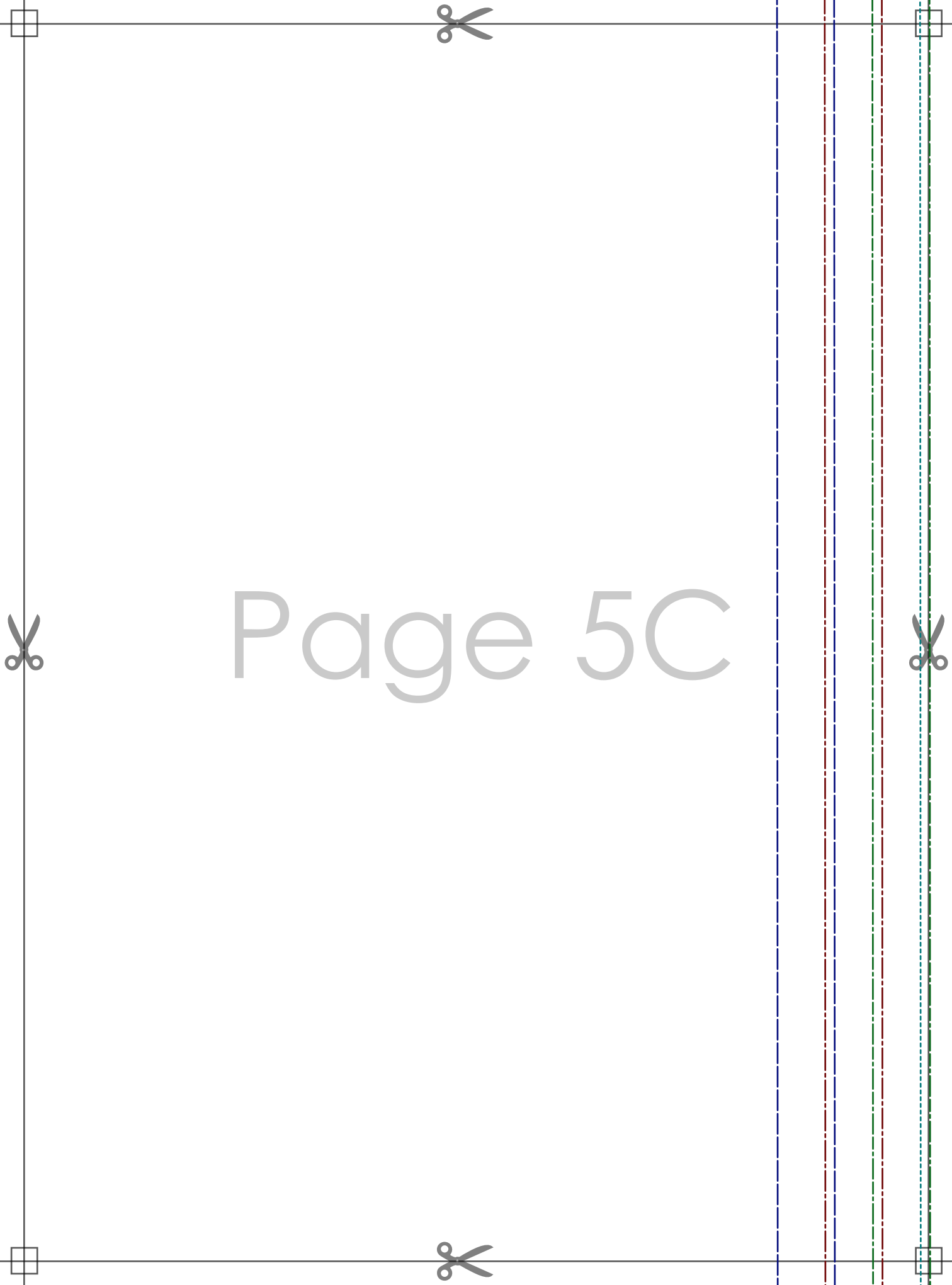

Page 5C

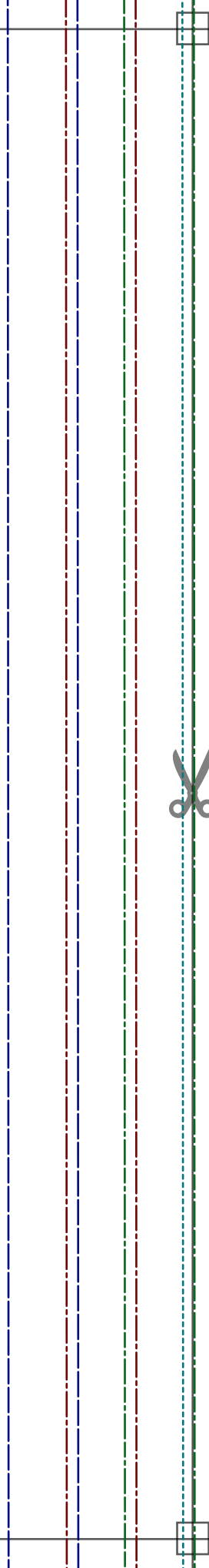

Page 5D



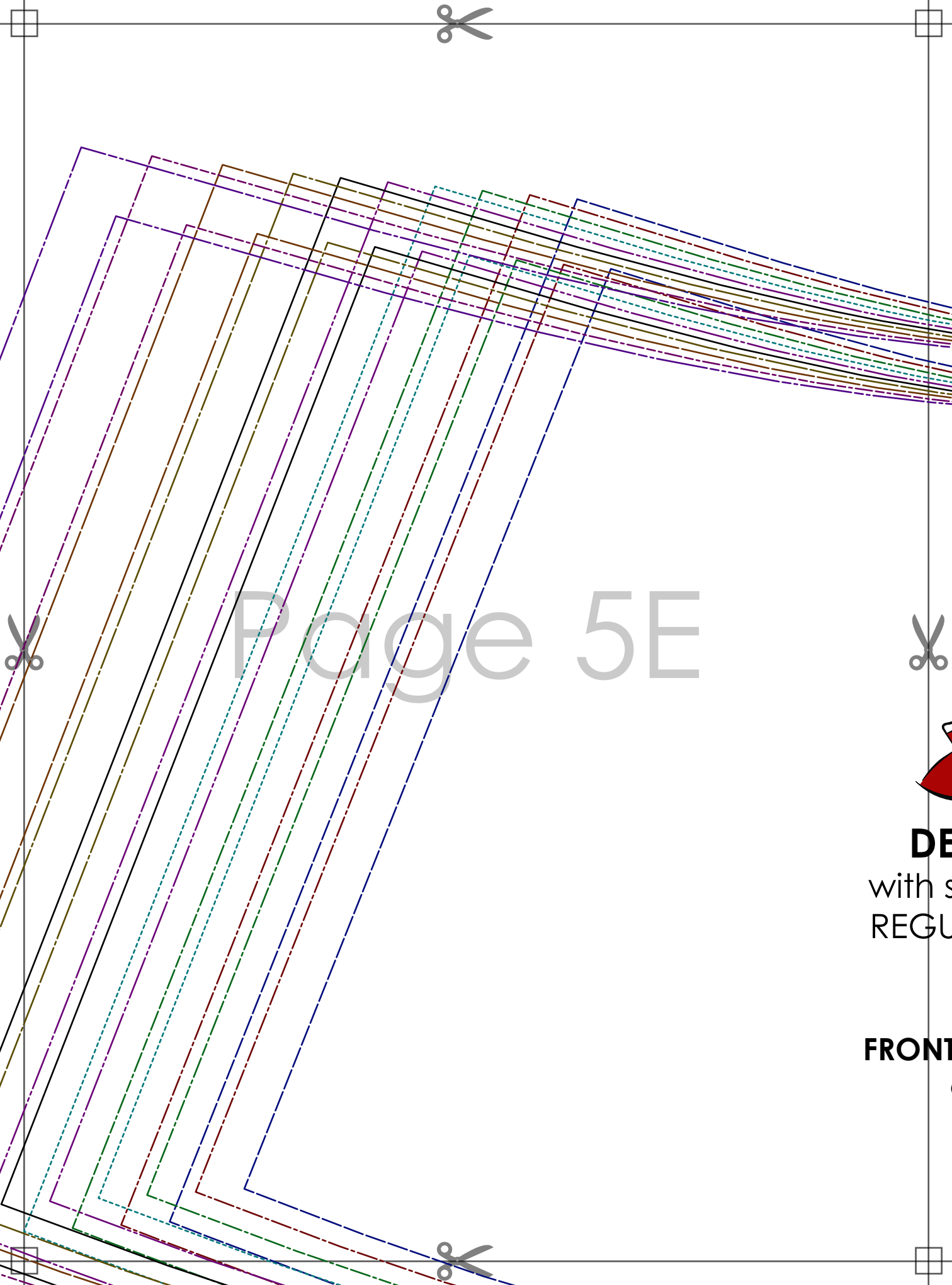

Page 5E

**DE**  
with s  
REGU

**FRONT**

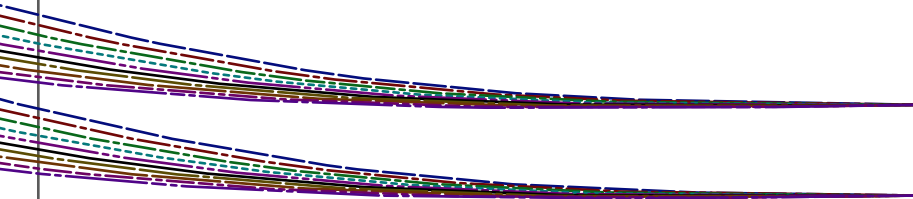

Page 5F



Tiana's  
*Closet*

## DEVON DRESS

with seam allowance  
REGULAR SIZE RANGE

Size: ~~XXXX~~

FRONT SKIRT - UPPER TIER  
cut 1 on fold

Grainline

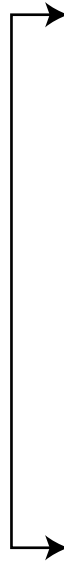

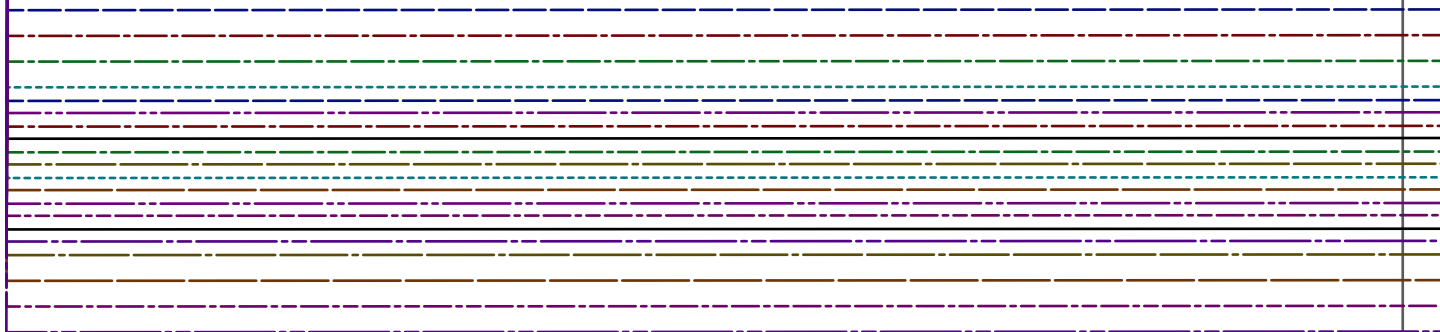

Page 6A

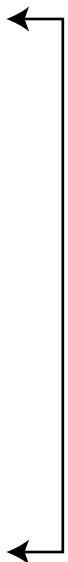

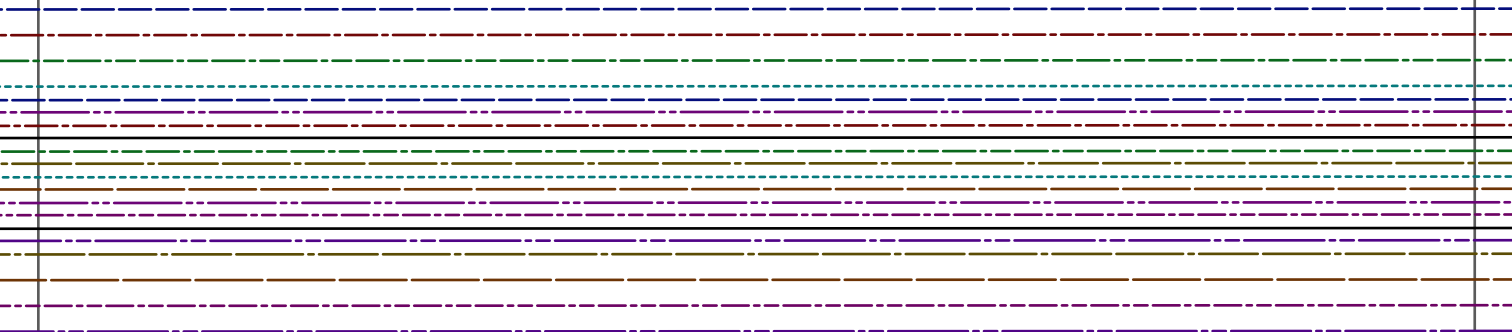

Page 6B

Grainline



cut 2





Tiana's  
*Closet*

Page 6C

## DEVON DRESS

with seam allowance  
REGULAR SIZE RANGE

Size: ~~XS~~

**SKIRT - LOWER TIER**

**cut 2 on fold (1 back + 1 front)**

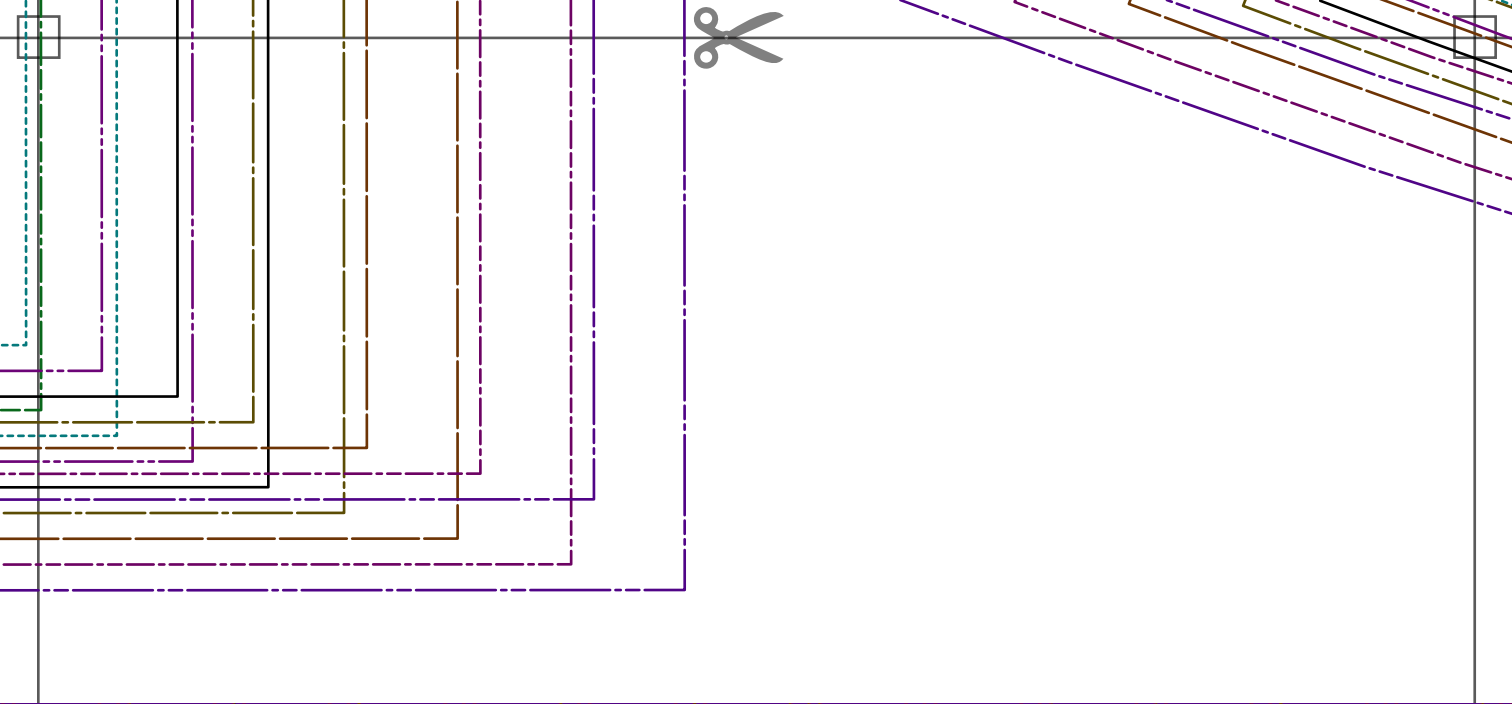

Page 6D





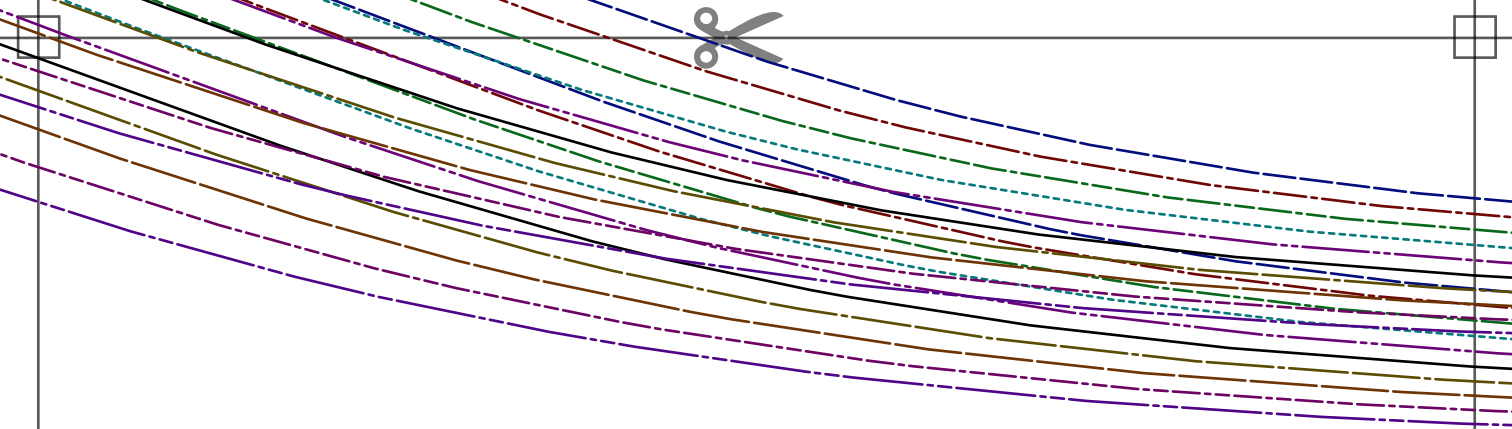

Page 6E



