

Page 1A

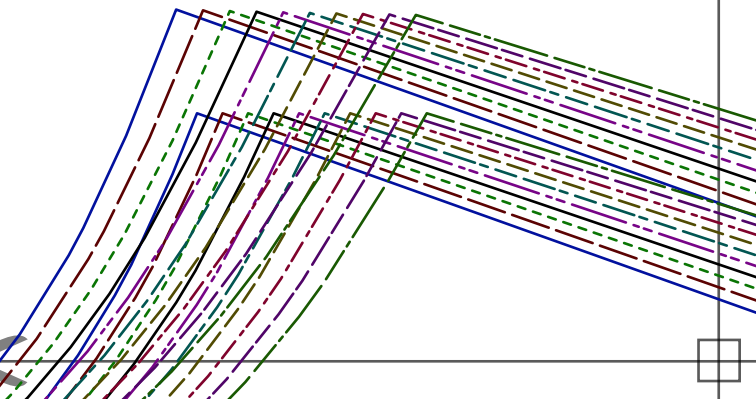

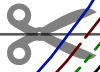

Page 1 B

SLEEVE  
cut 2

Size: ~~XXX~~

with seam allowance

**MINA BABY DOLL DRESS**

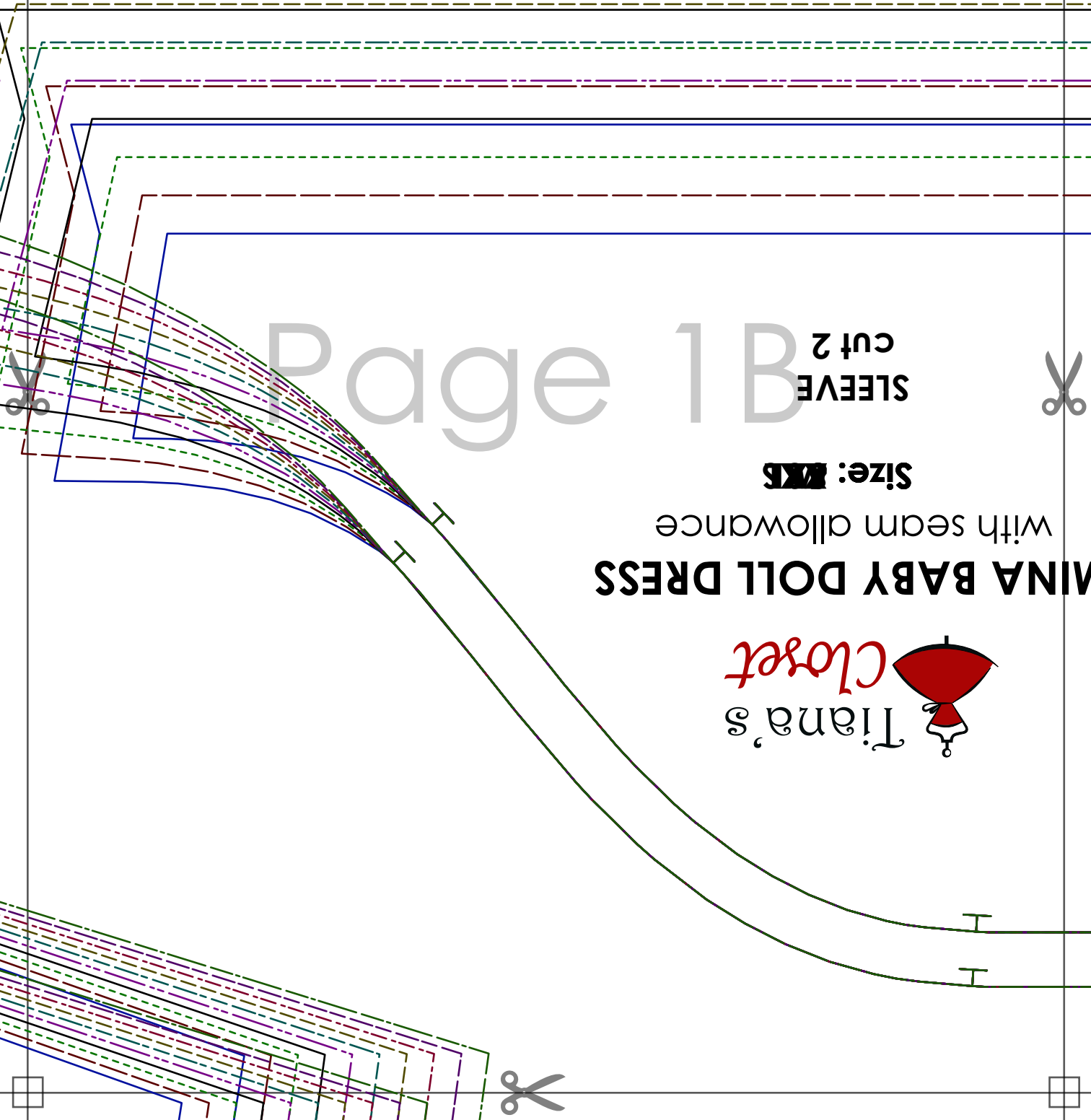

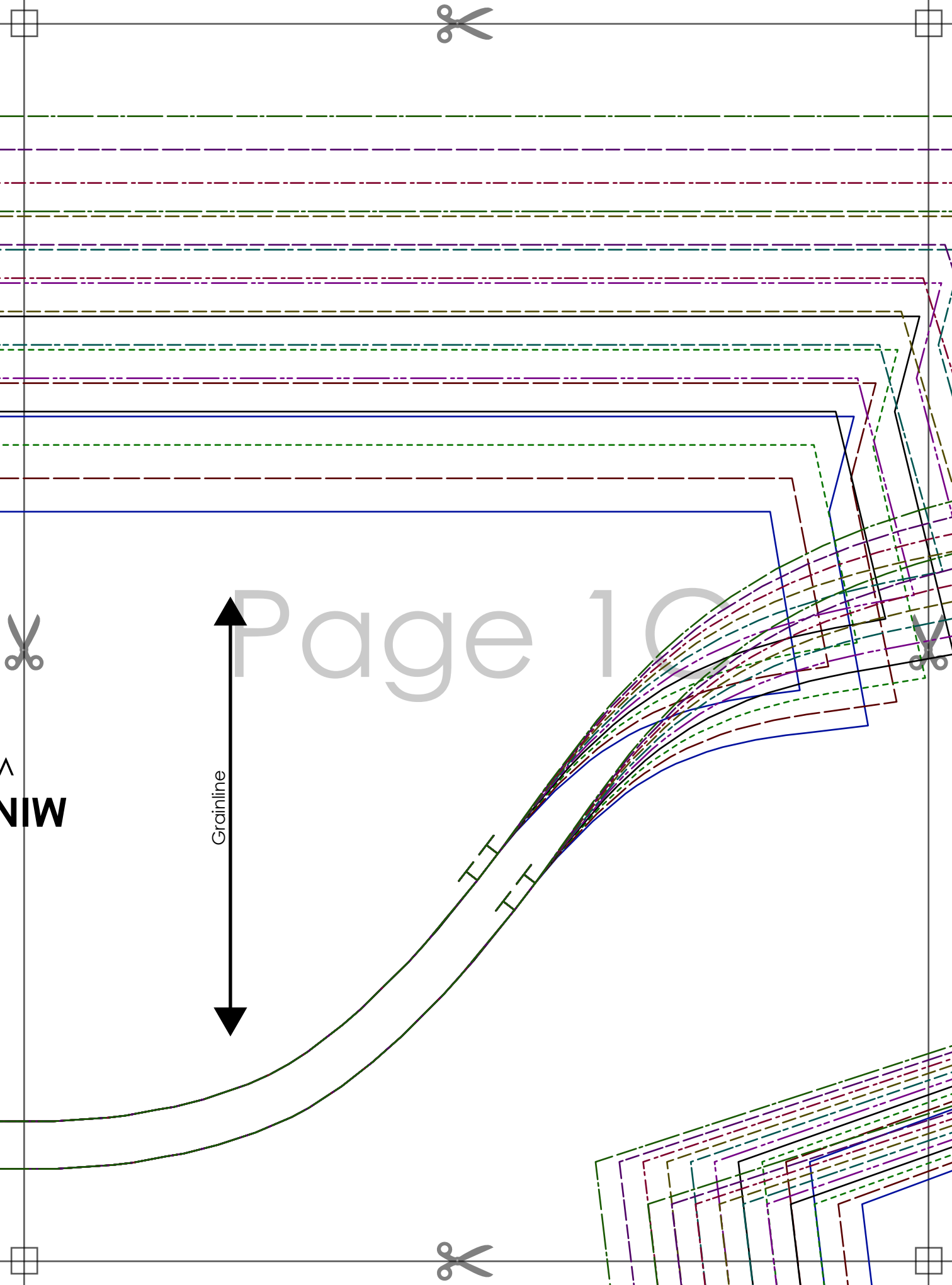

Grainline

Page 10

NIW

II

II

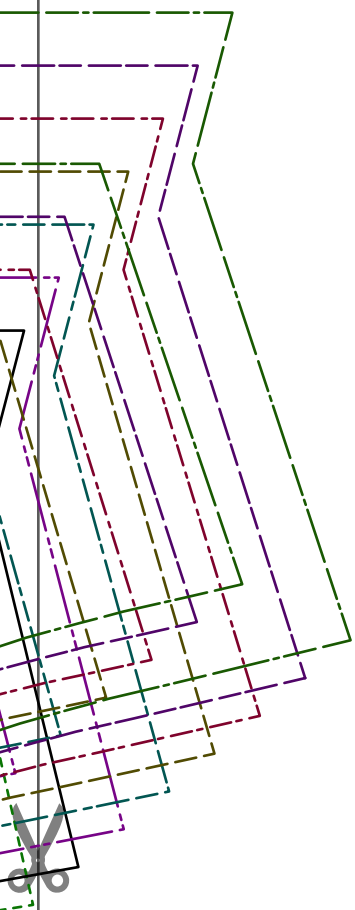

Page 1D

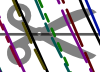
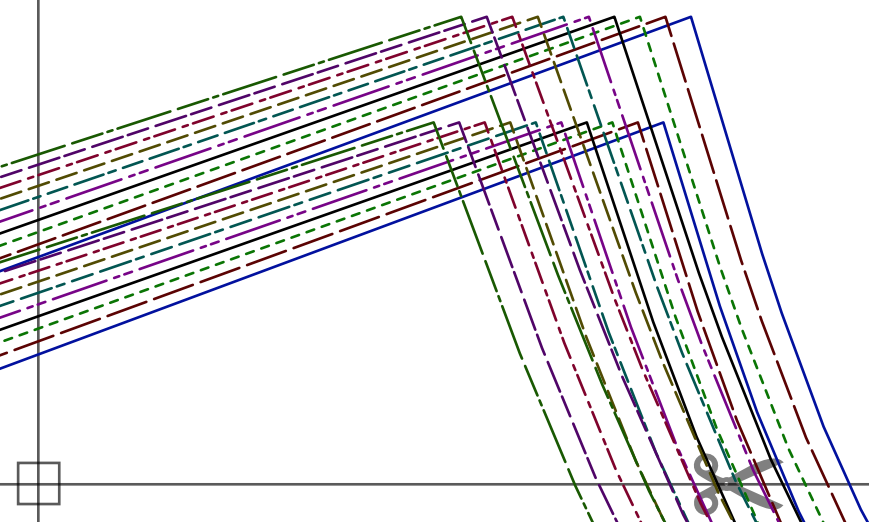

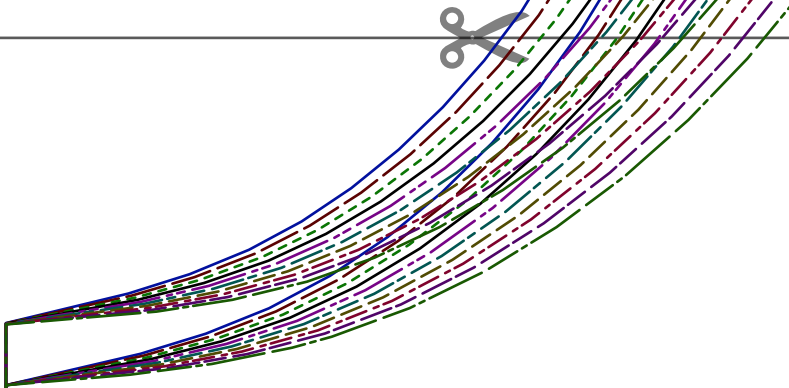

Page 2A

Fold along this line

Grainline



**MINA BABY DOLL DRESS**  
with seam allowance

**Size: ~~XS~~ S**

**BACK**  
cut 1 on fold

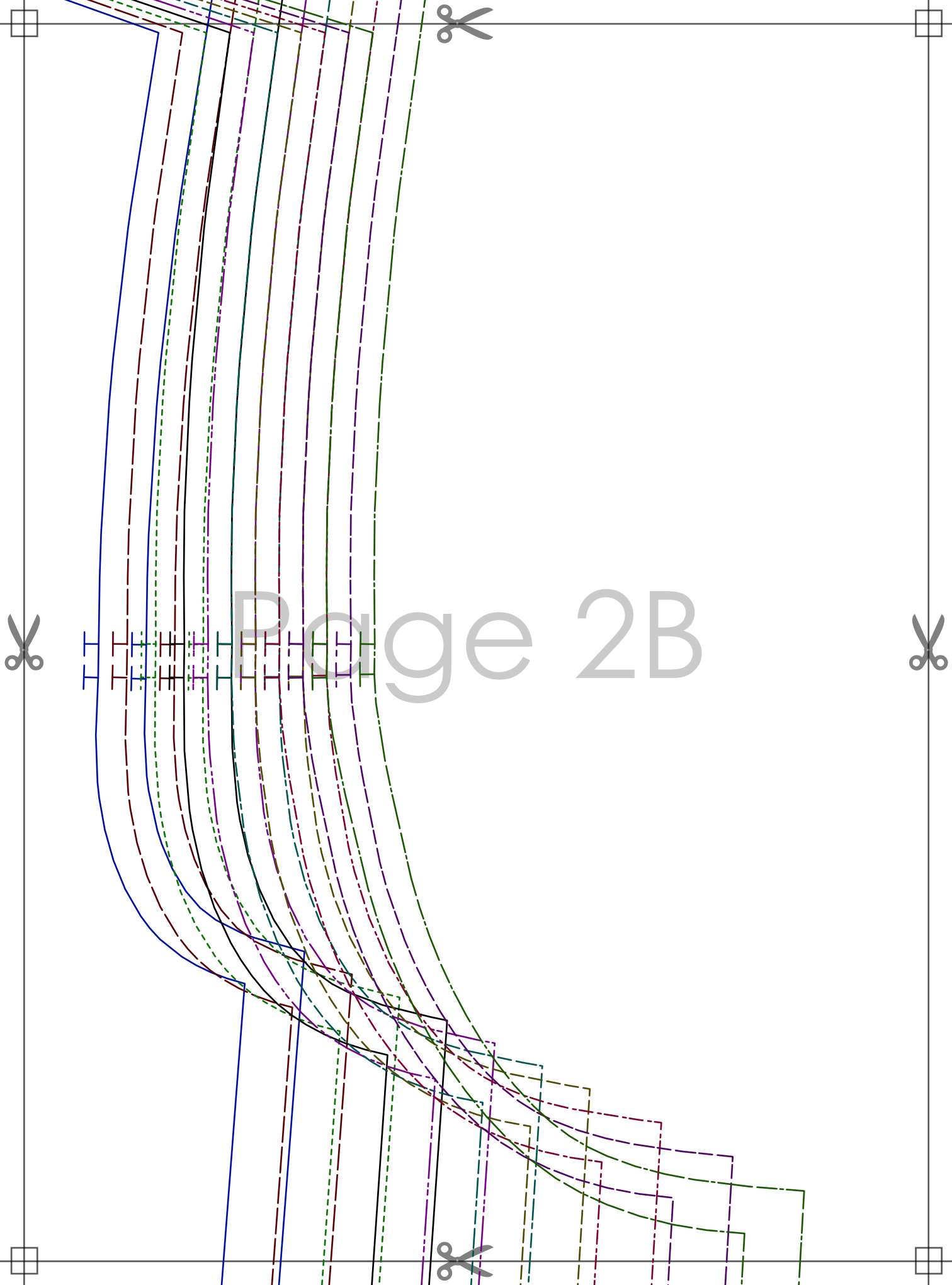

Page 2B

Page 20

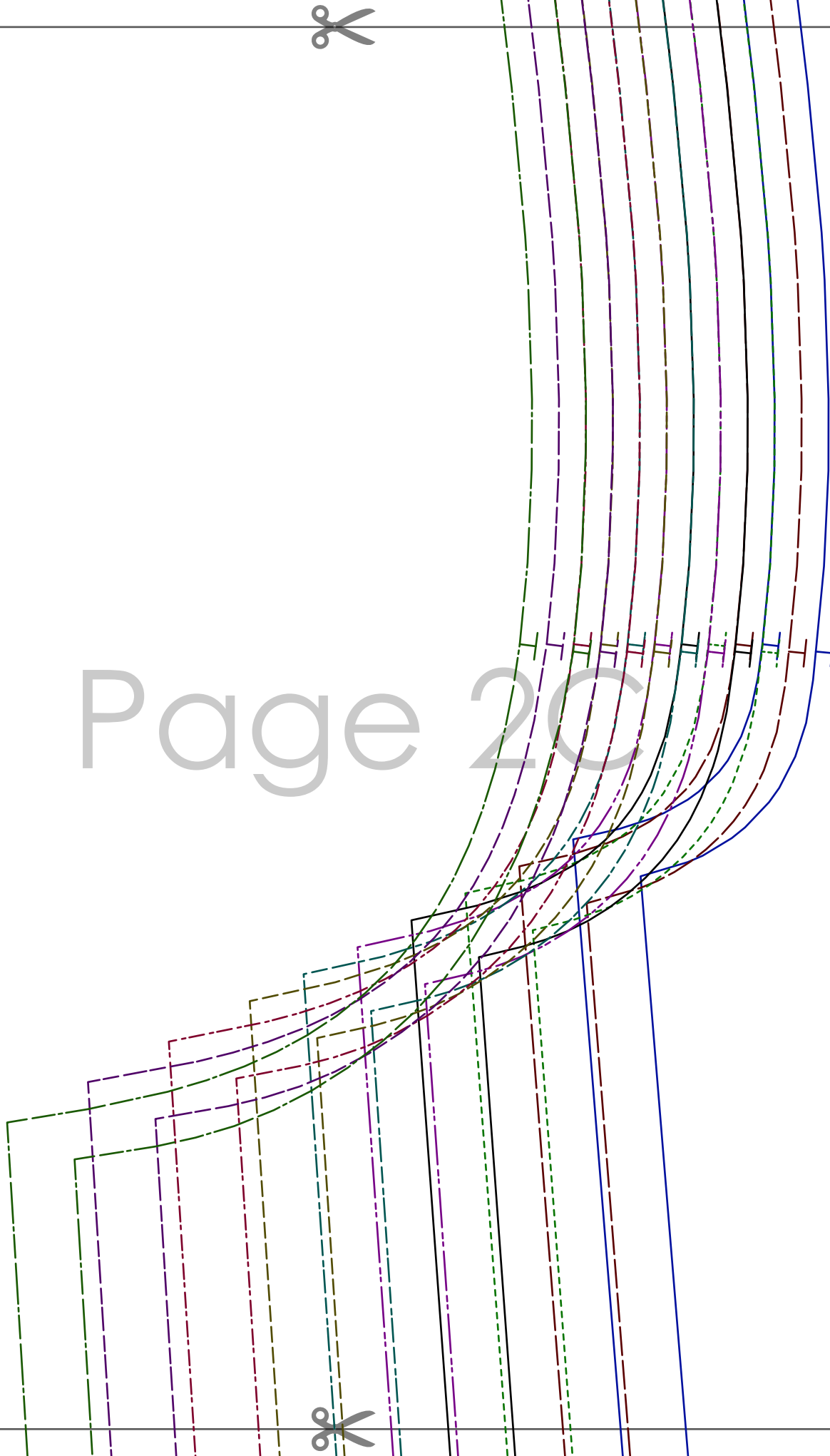
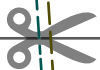

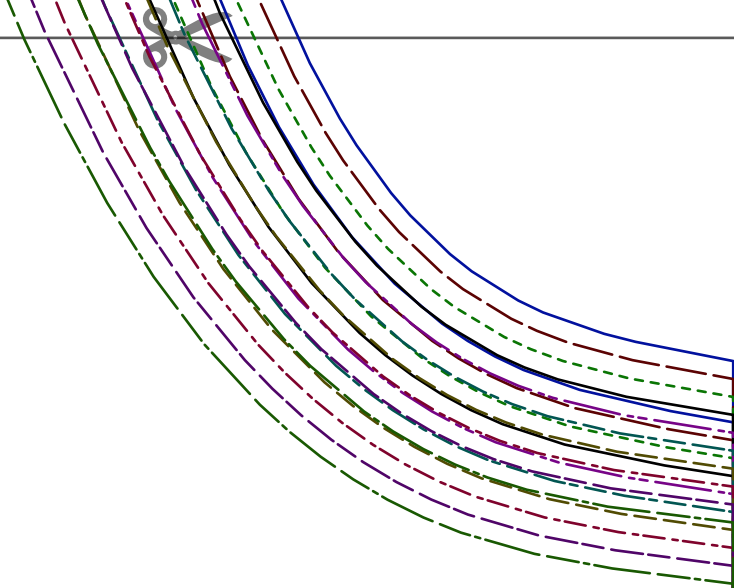

# Page 2D



## **MINA BABY DOLL DRESS**

with seam allowance

**Size: ~~XS~~ S**

**FRONT**  
**cut 1 on fold**

Grainline

Fold along this line







Page 3A



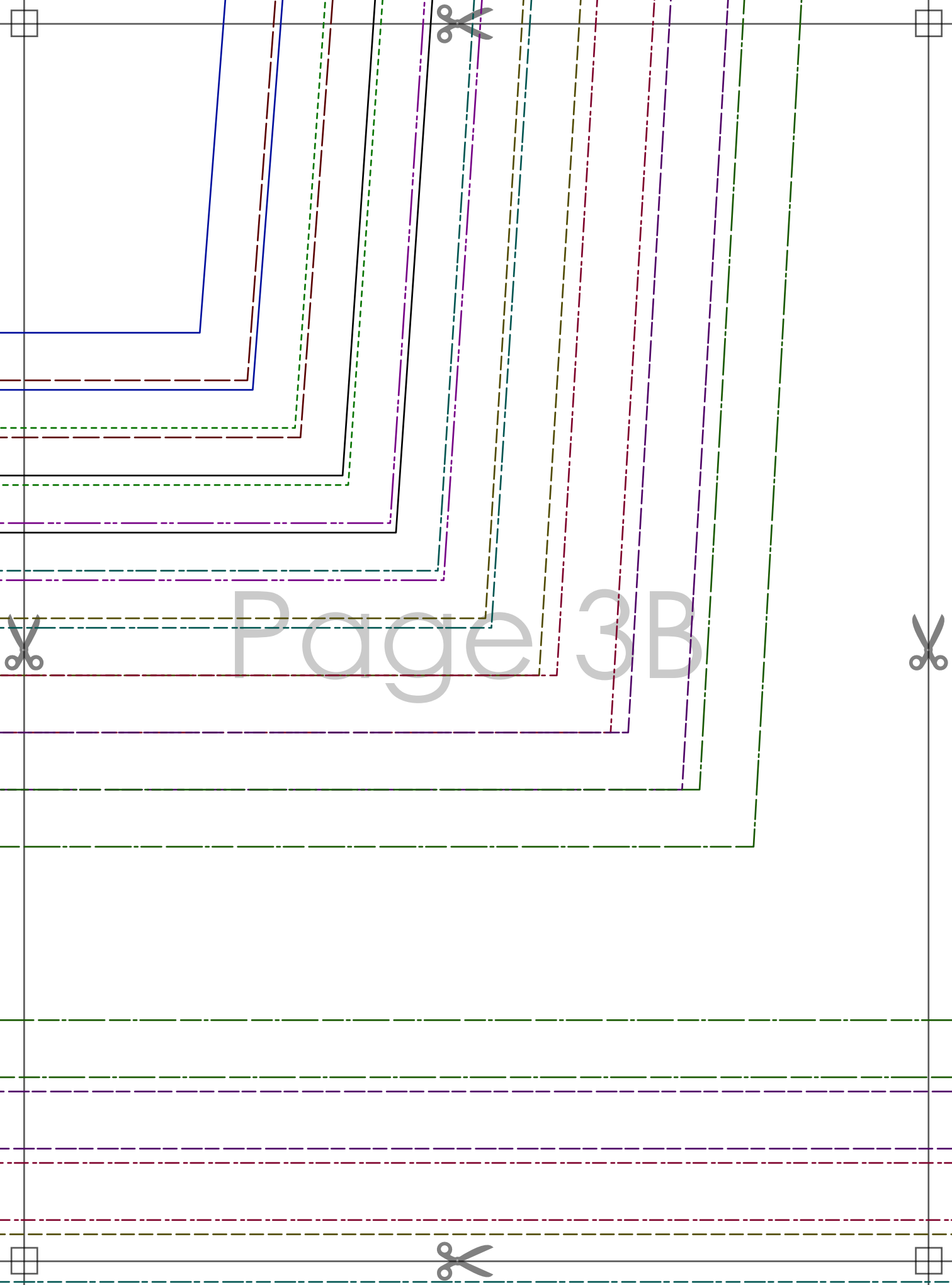

Page 3B

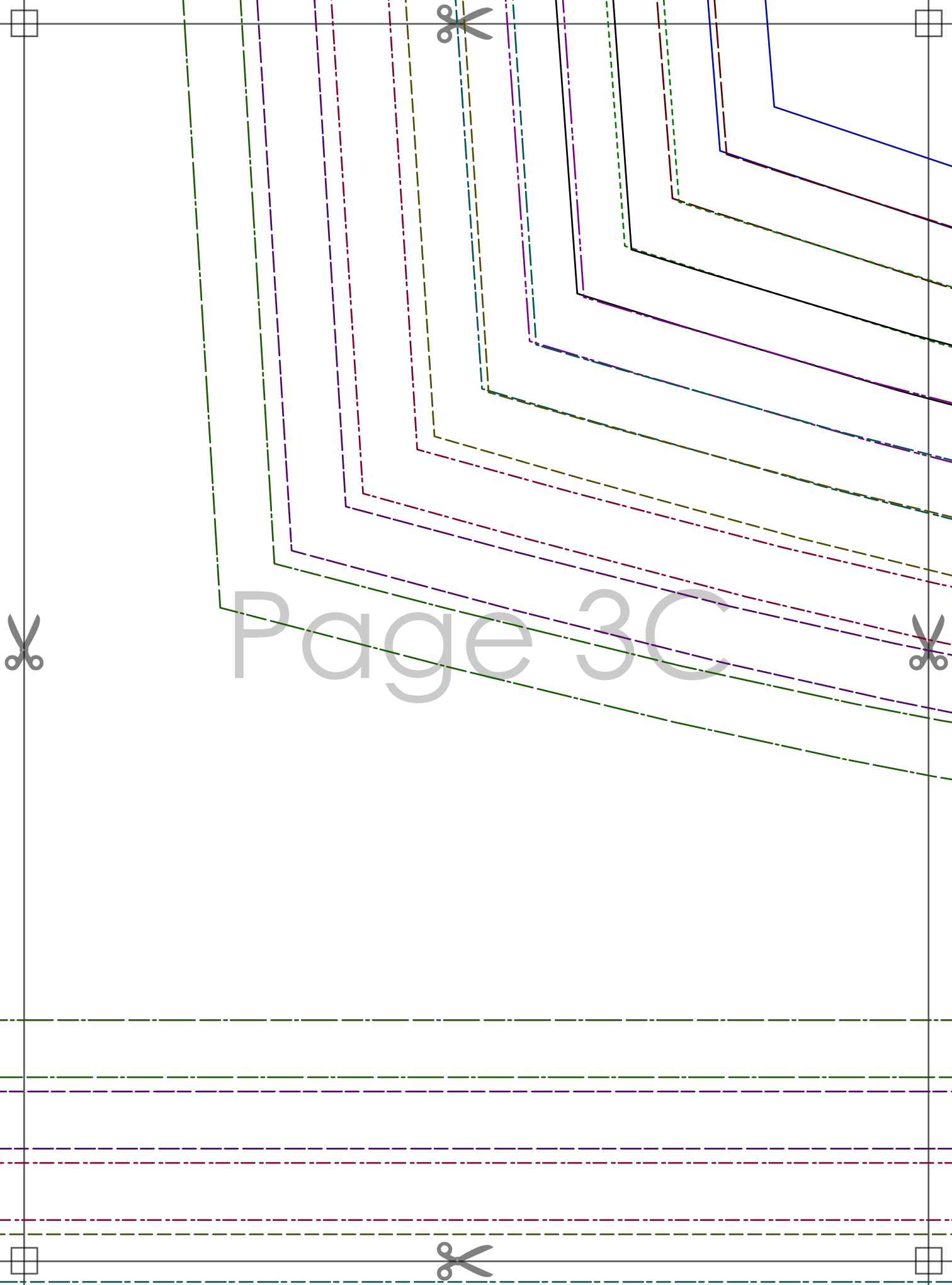

Page 3C

cut 1 on fold

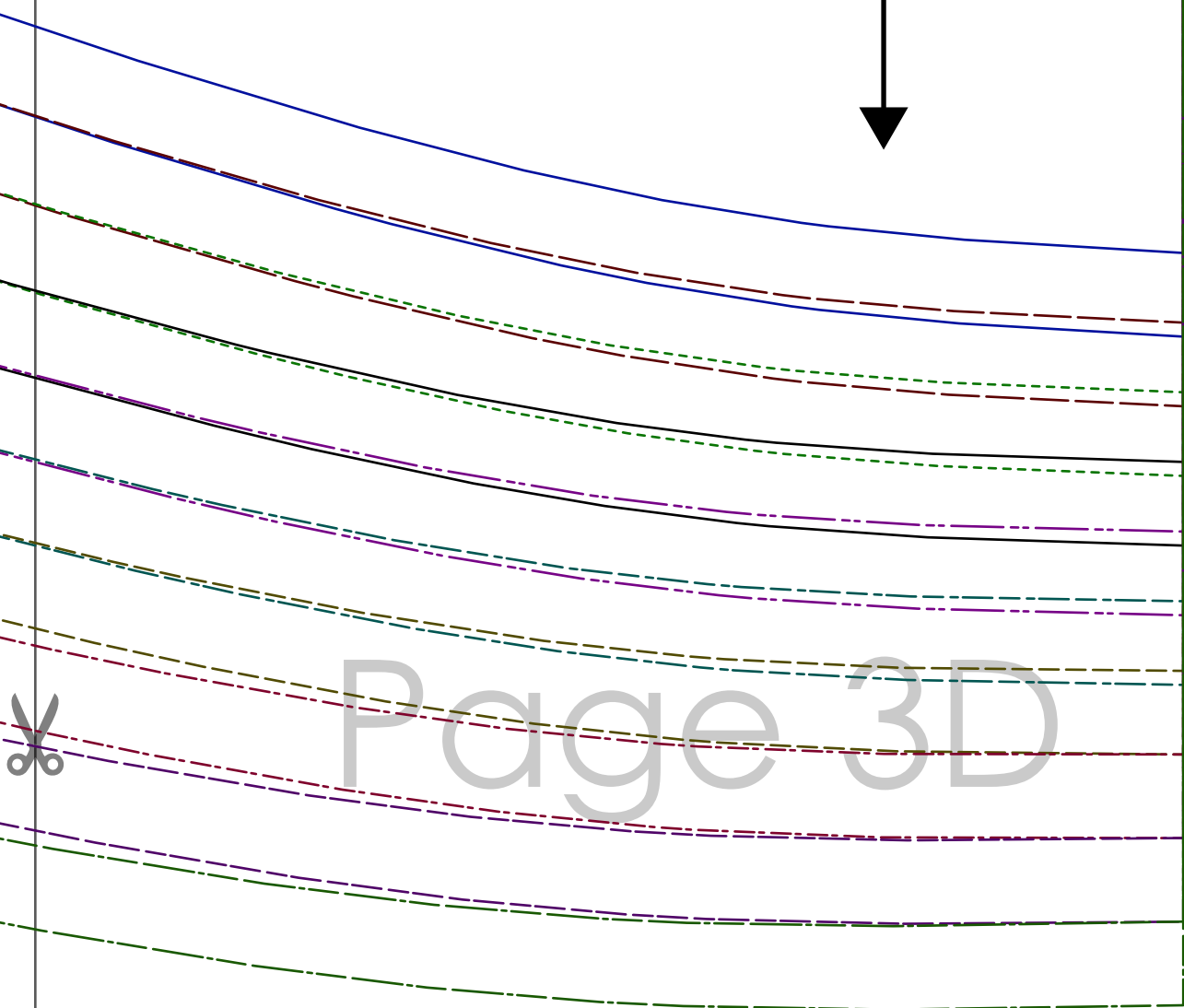

Page 3D

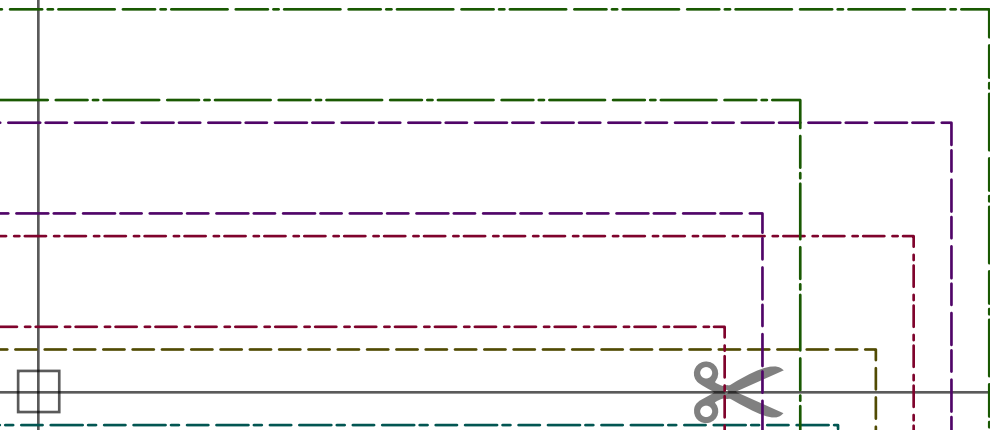

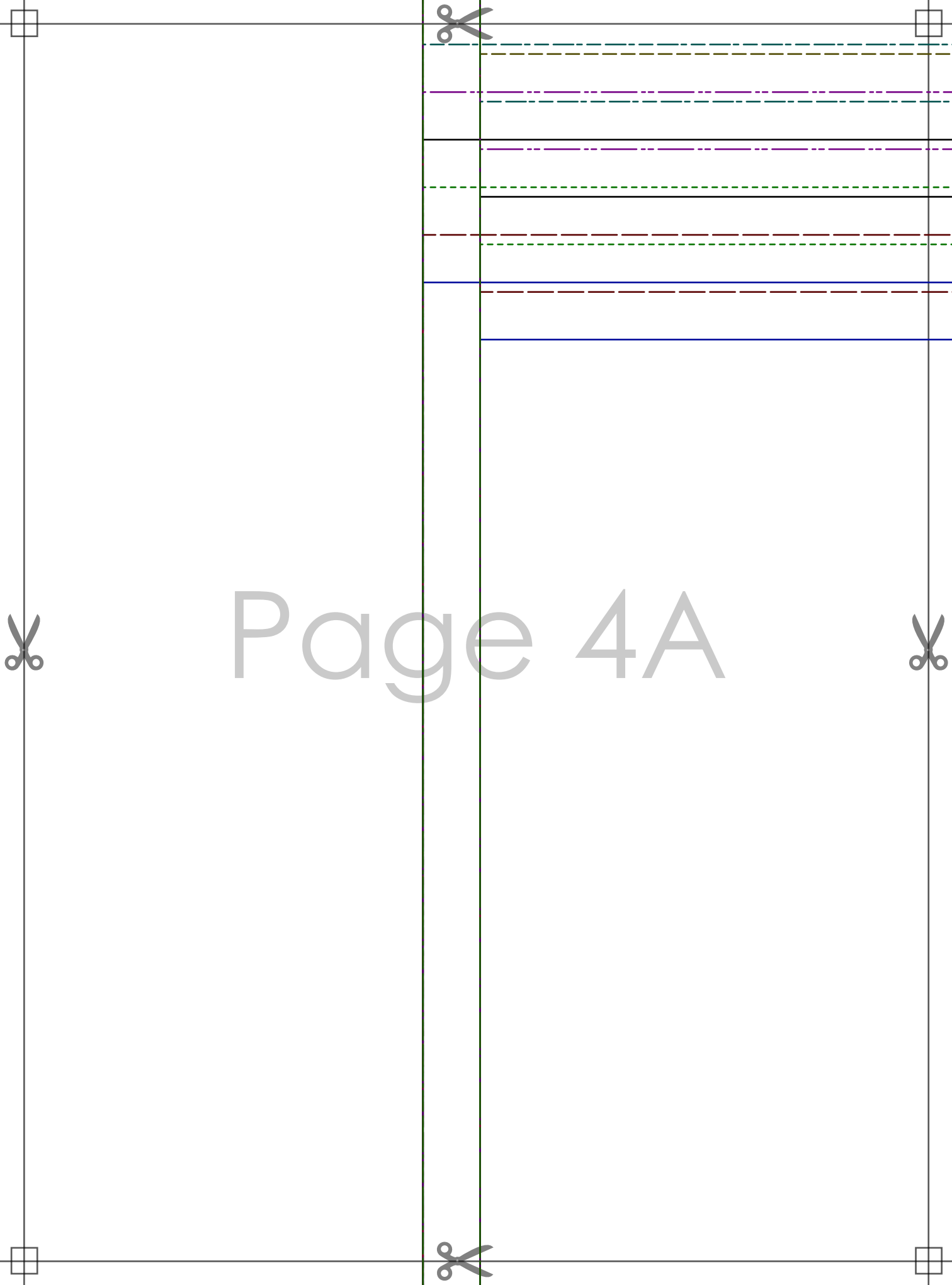

Page 4A

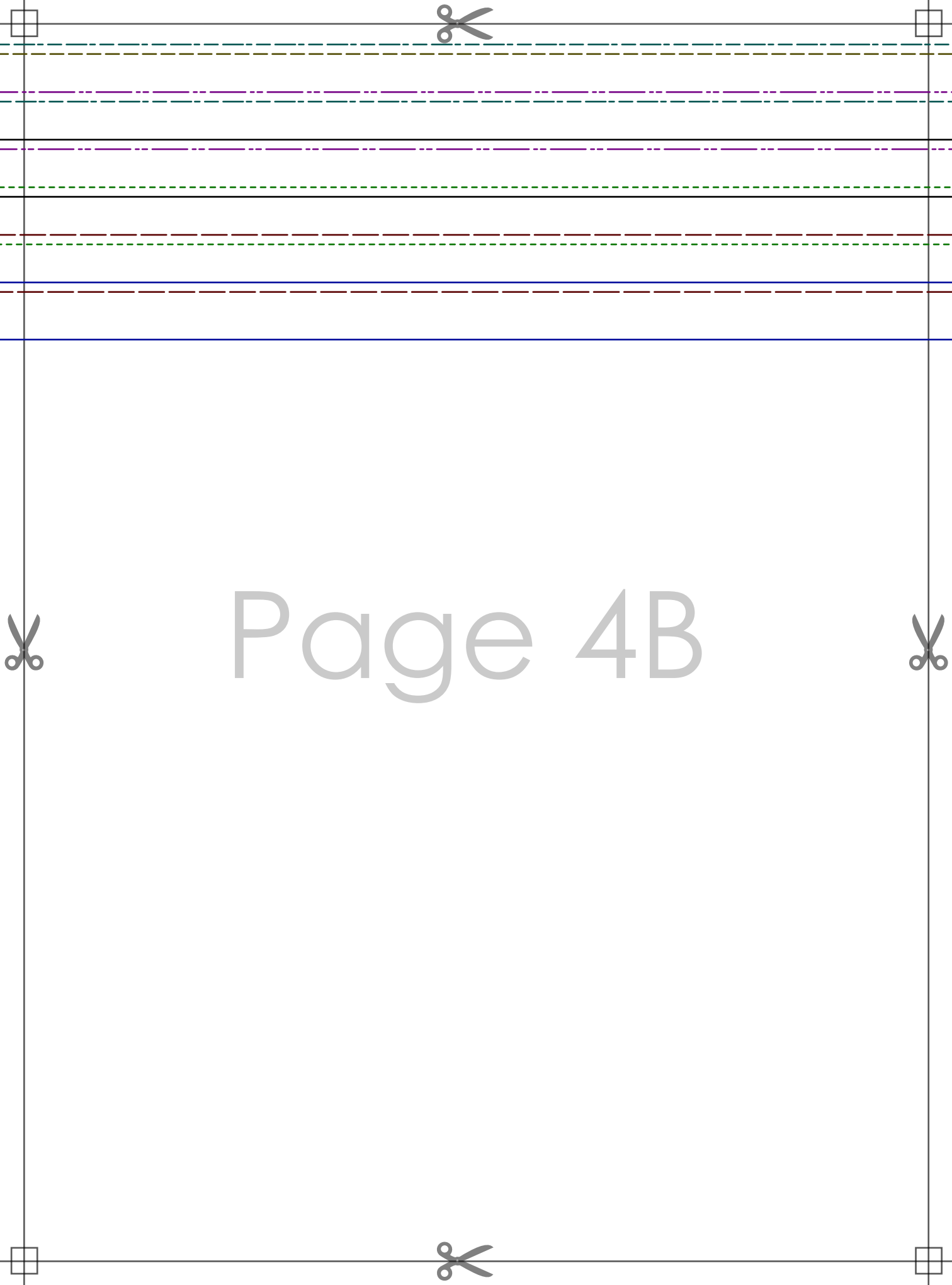

Page 4B

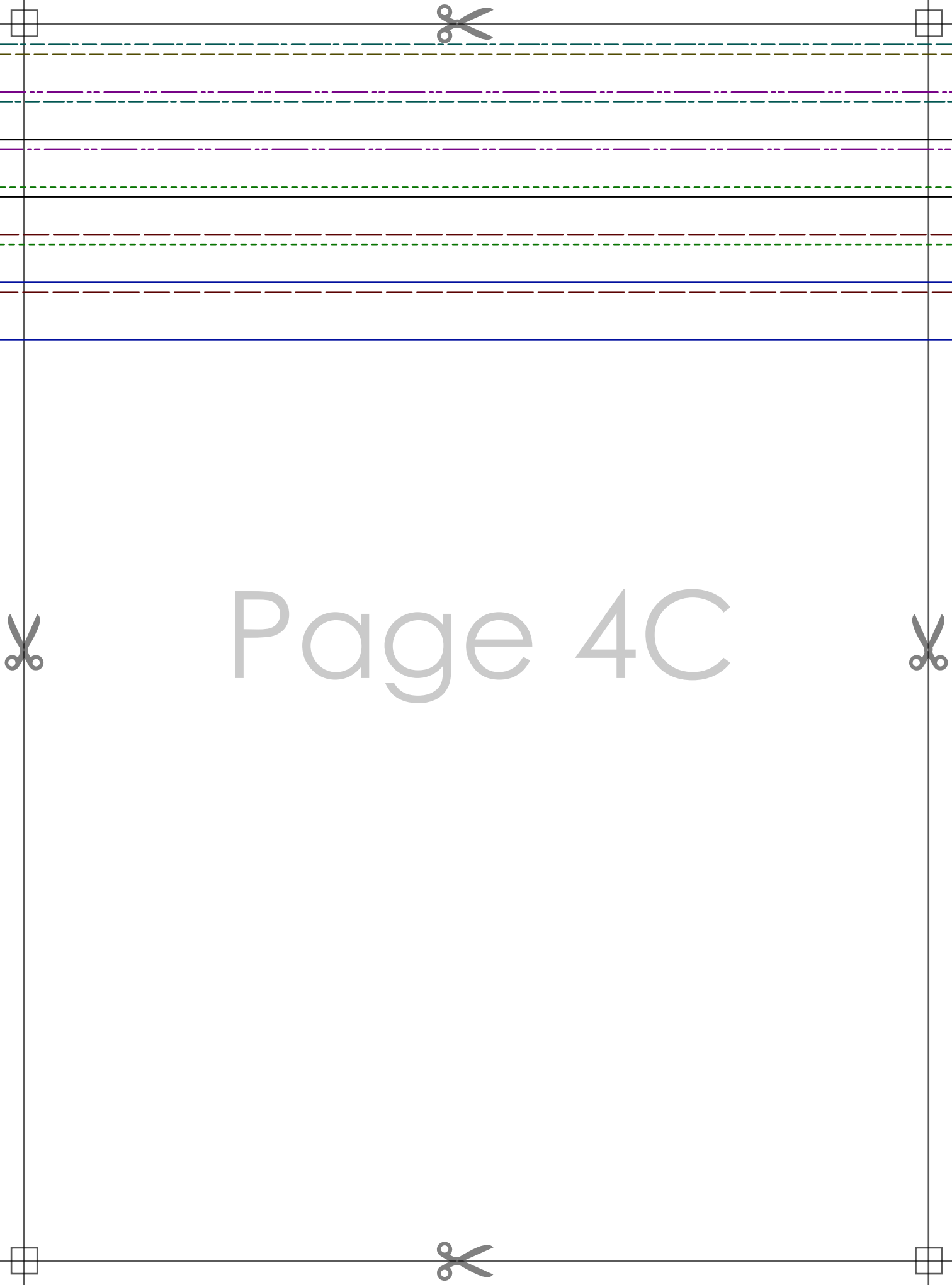

Page 4C

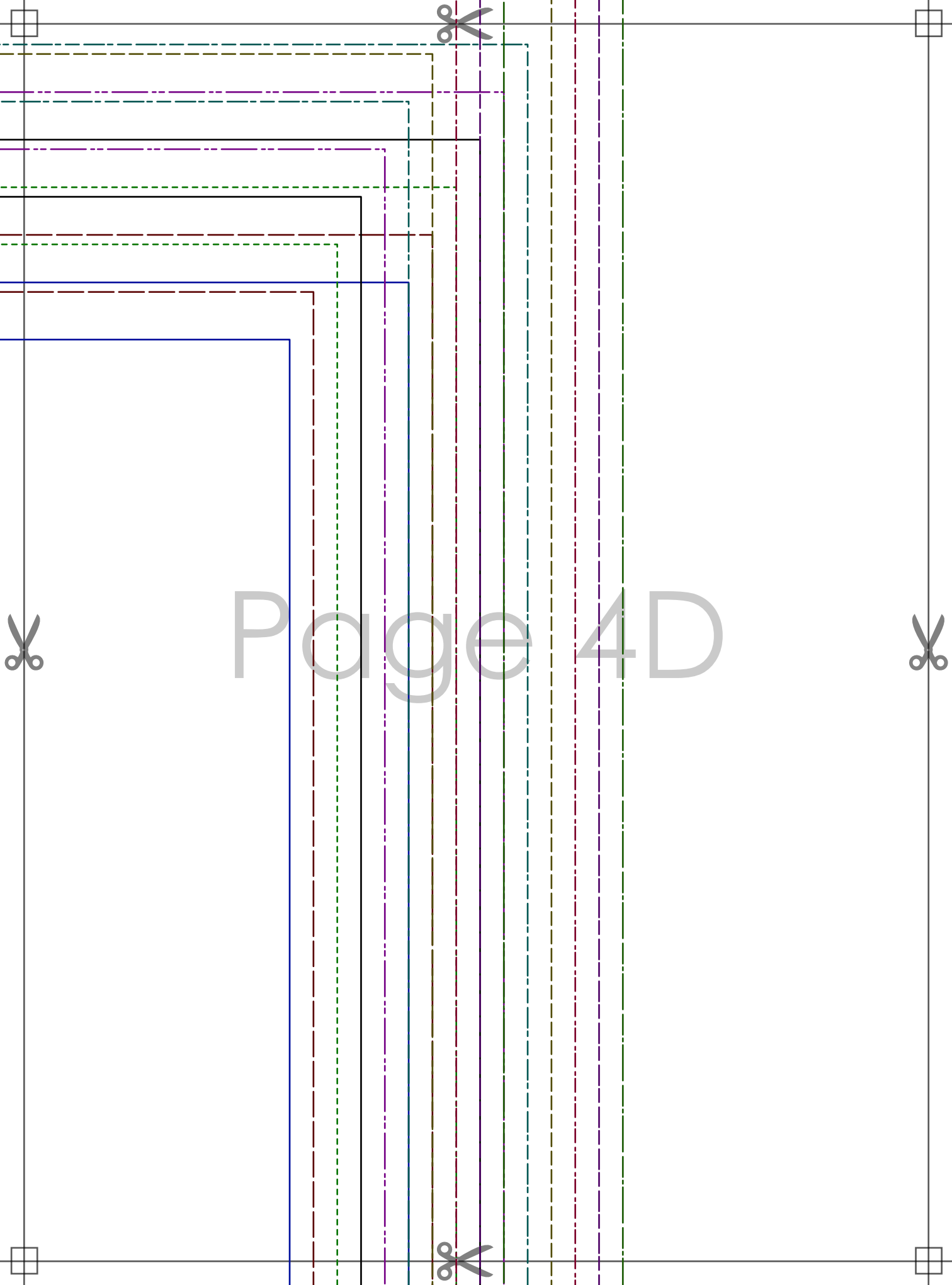

Page 4D



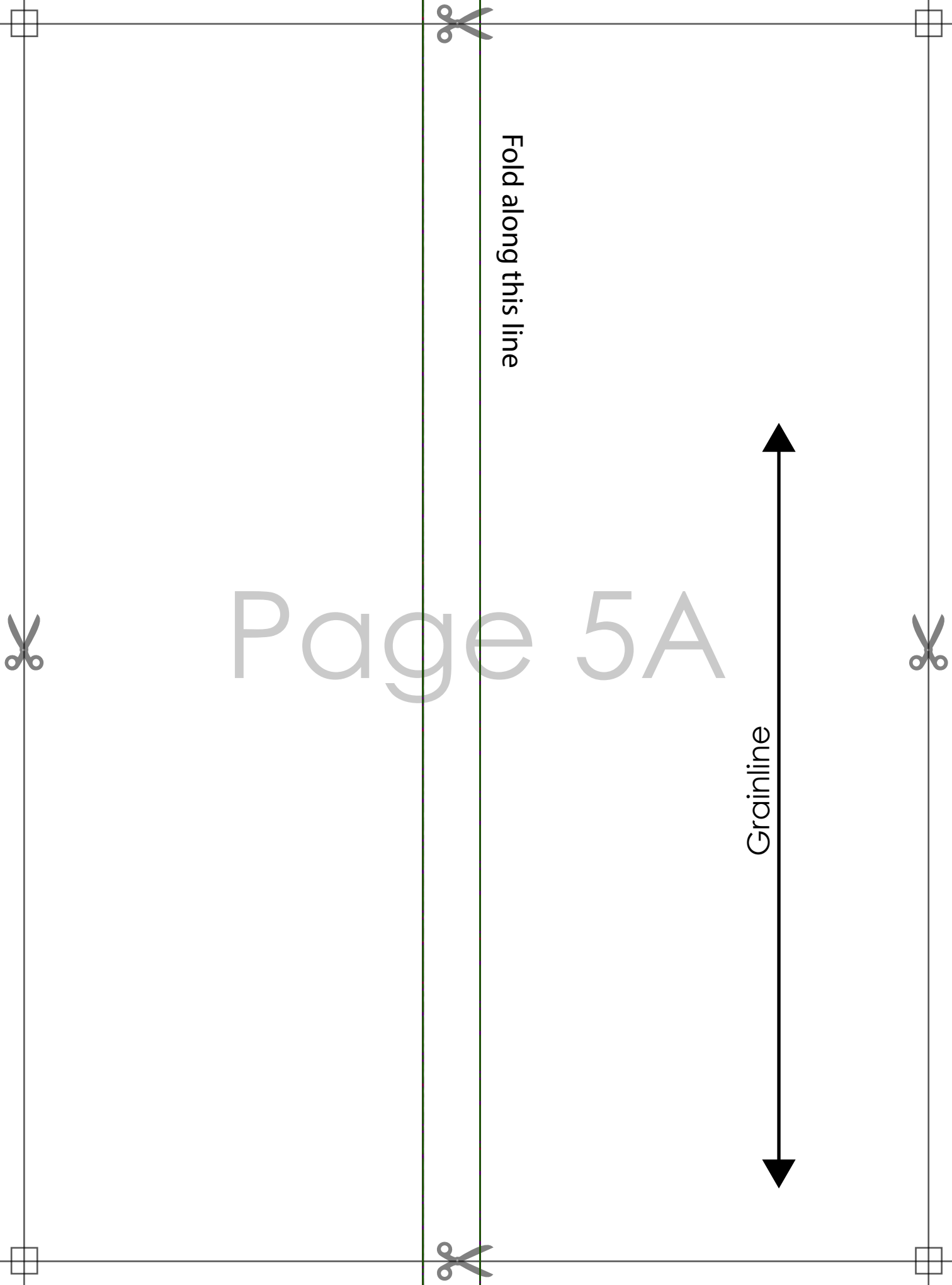

Fold along this line

Page 5A

Grainline



## **MINA BABY DOLL DRESS**

with seam allowance

**Size: ~~XXX~~**

**SKIRT**

**cut 2 on fold (1 back + 1 front)**

Page 5B

Page 5C

Page 5D

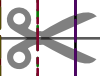
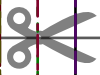

Page 6A

Page 6B

Page 6C

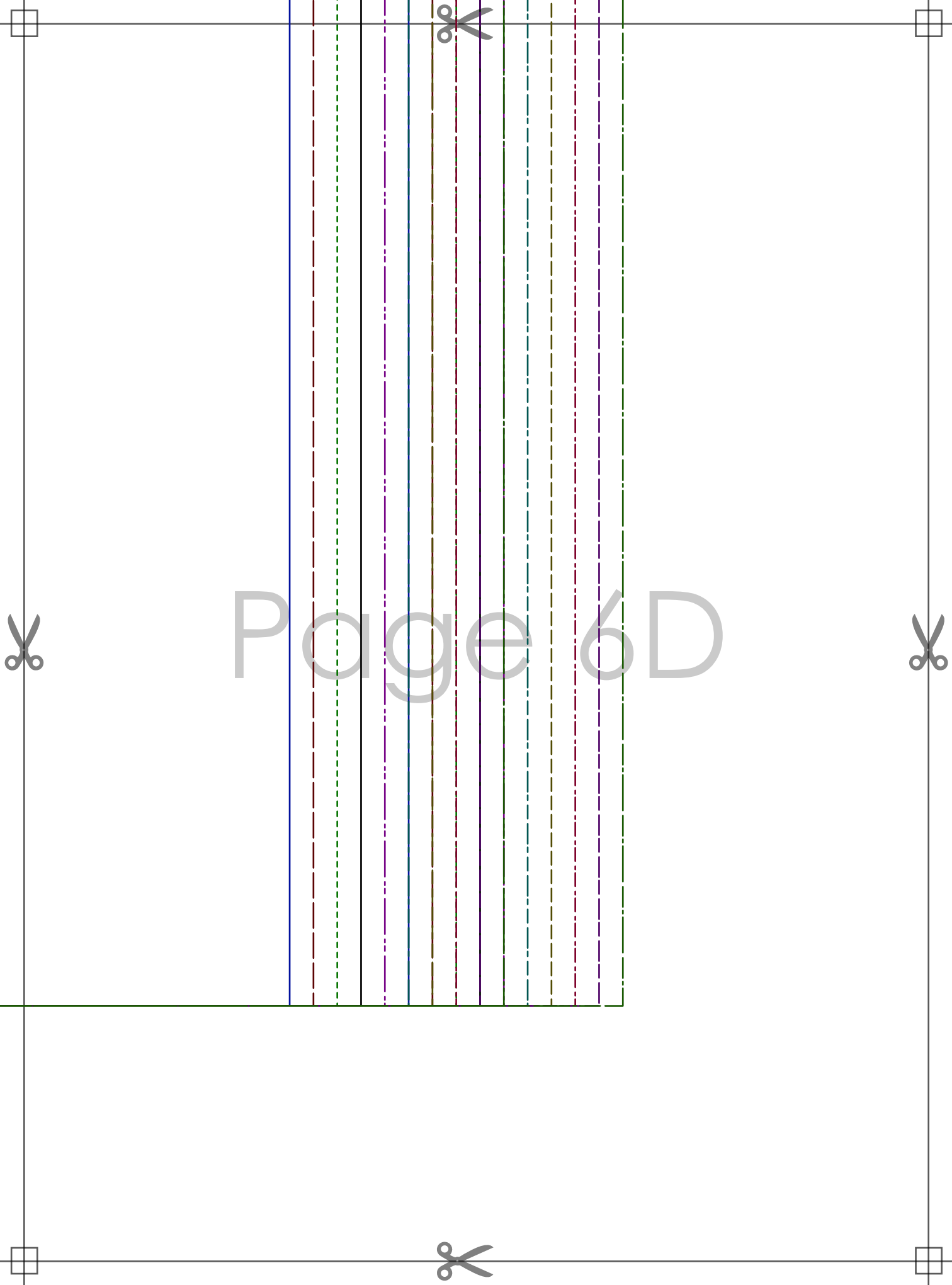

Page 6D