

Page 1 A

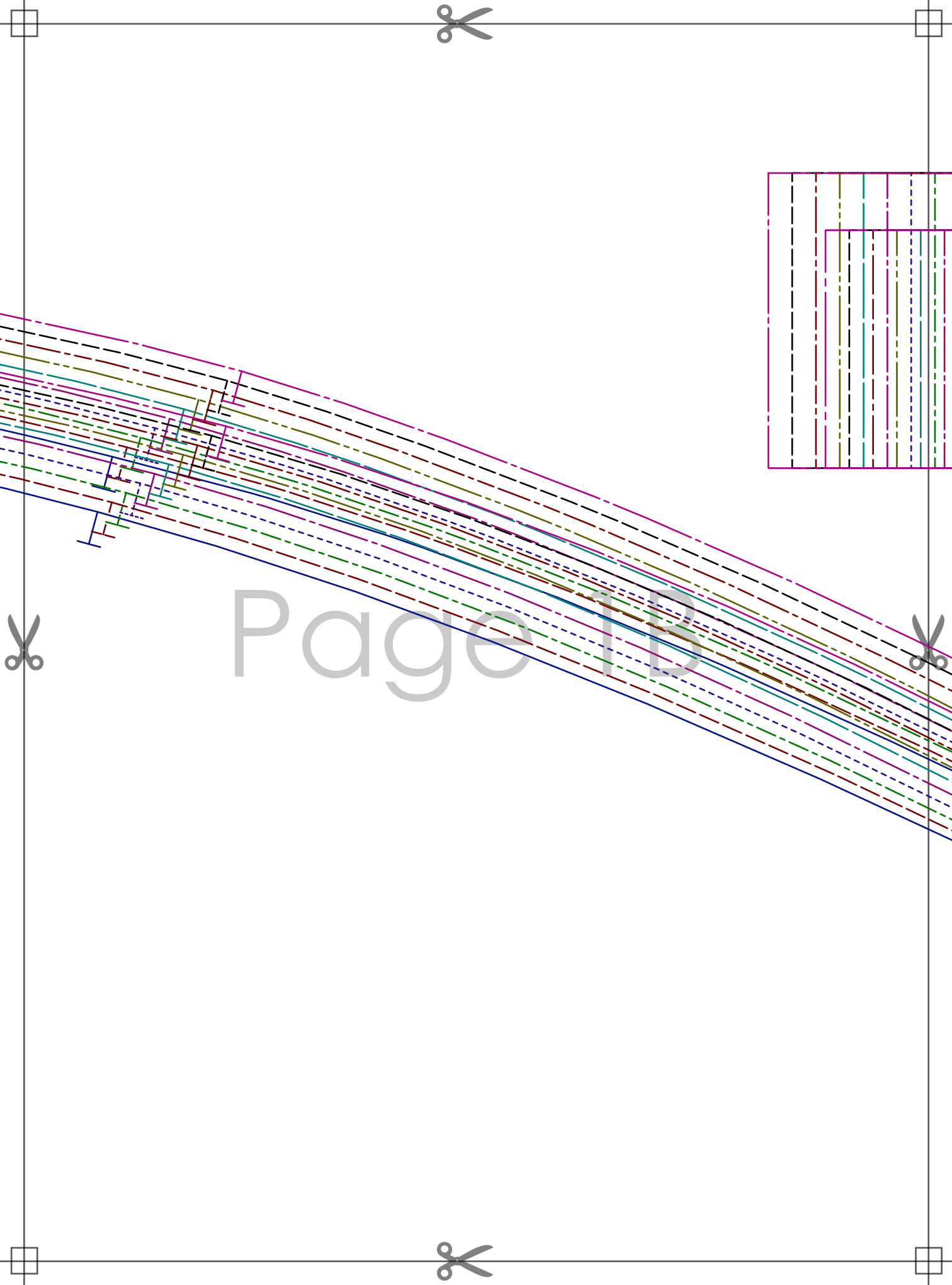





AMY BATWING TOP
with seam allowance

Size: XS

CUFF
cut 2 on fold

Page 1C

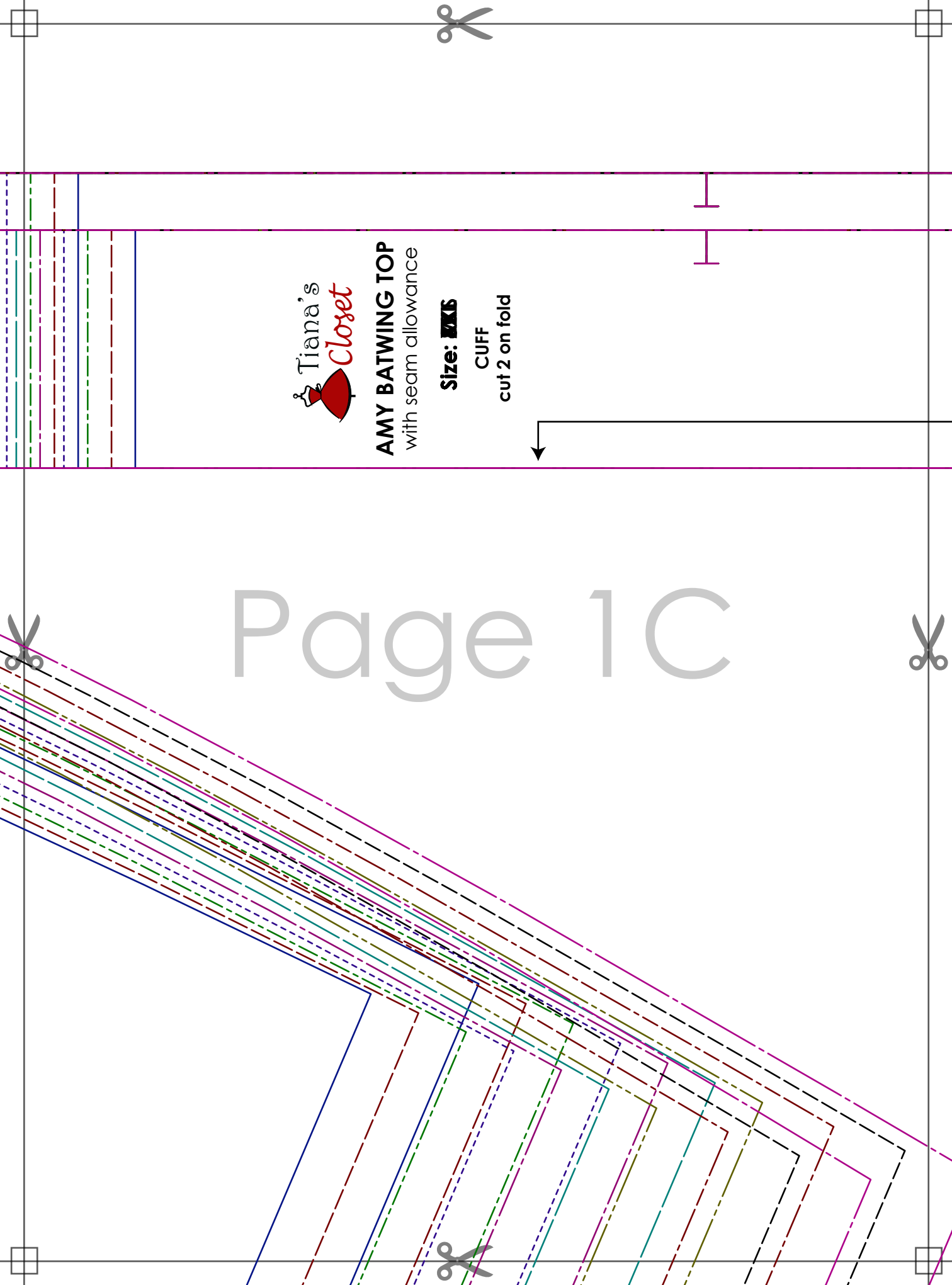

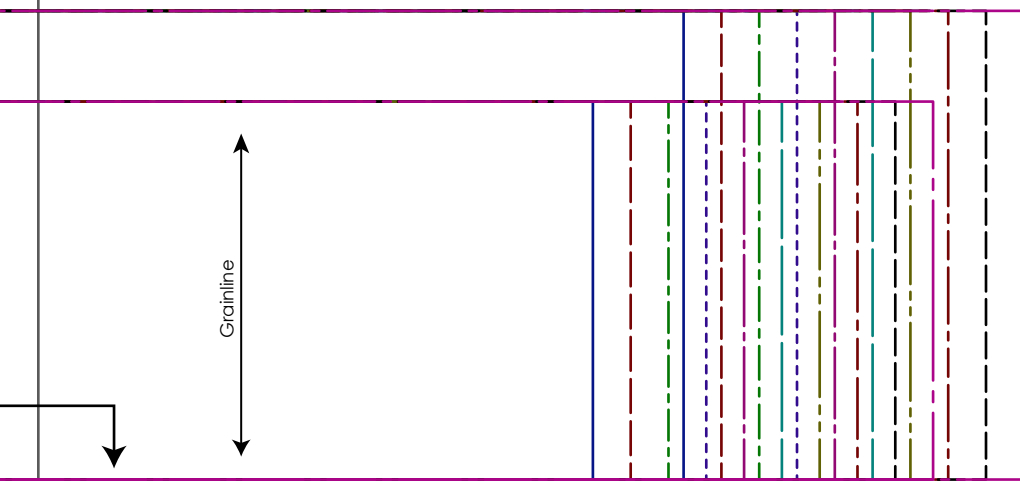

Page 1D



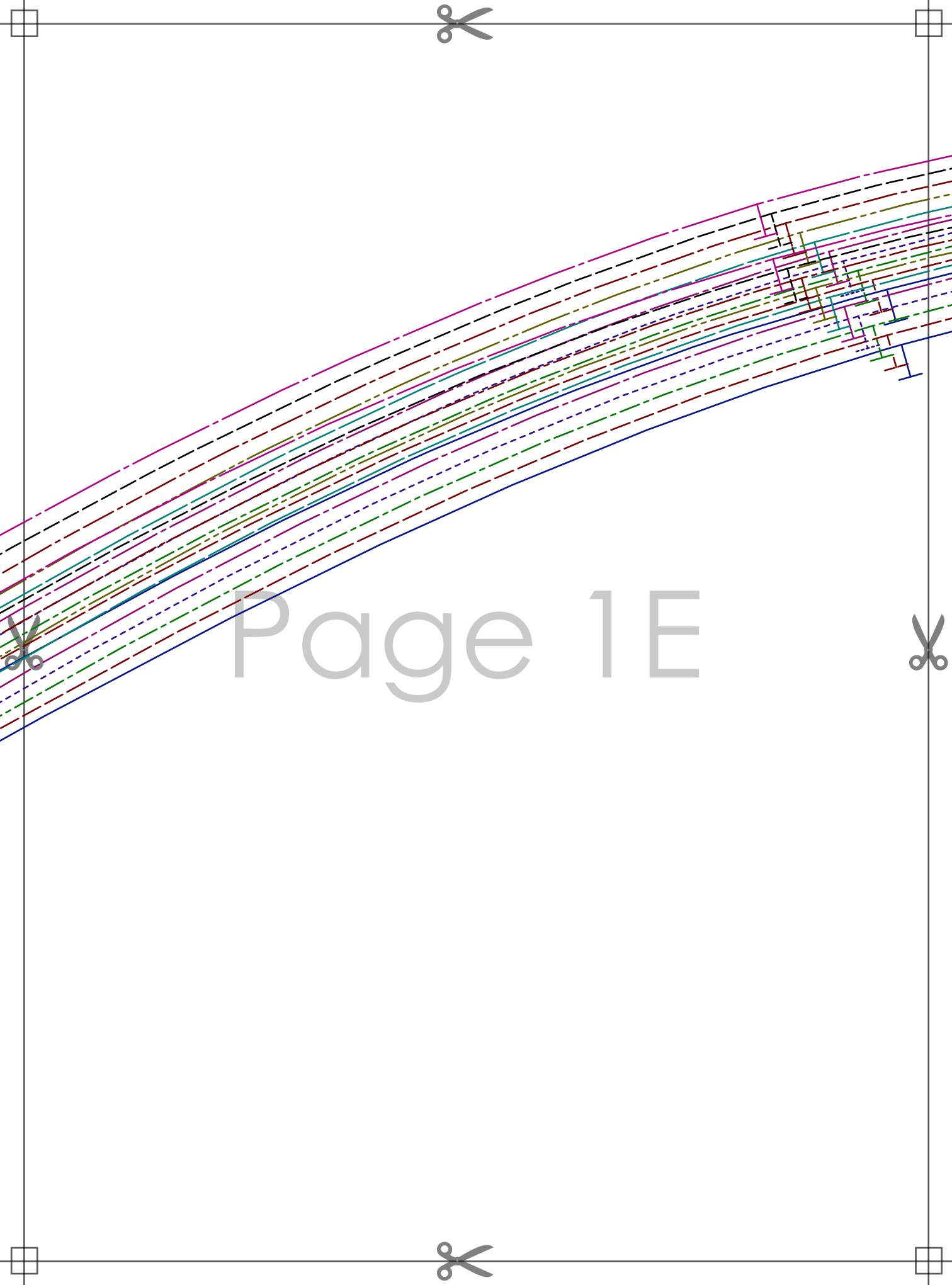

Page 1E

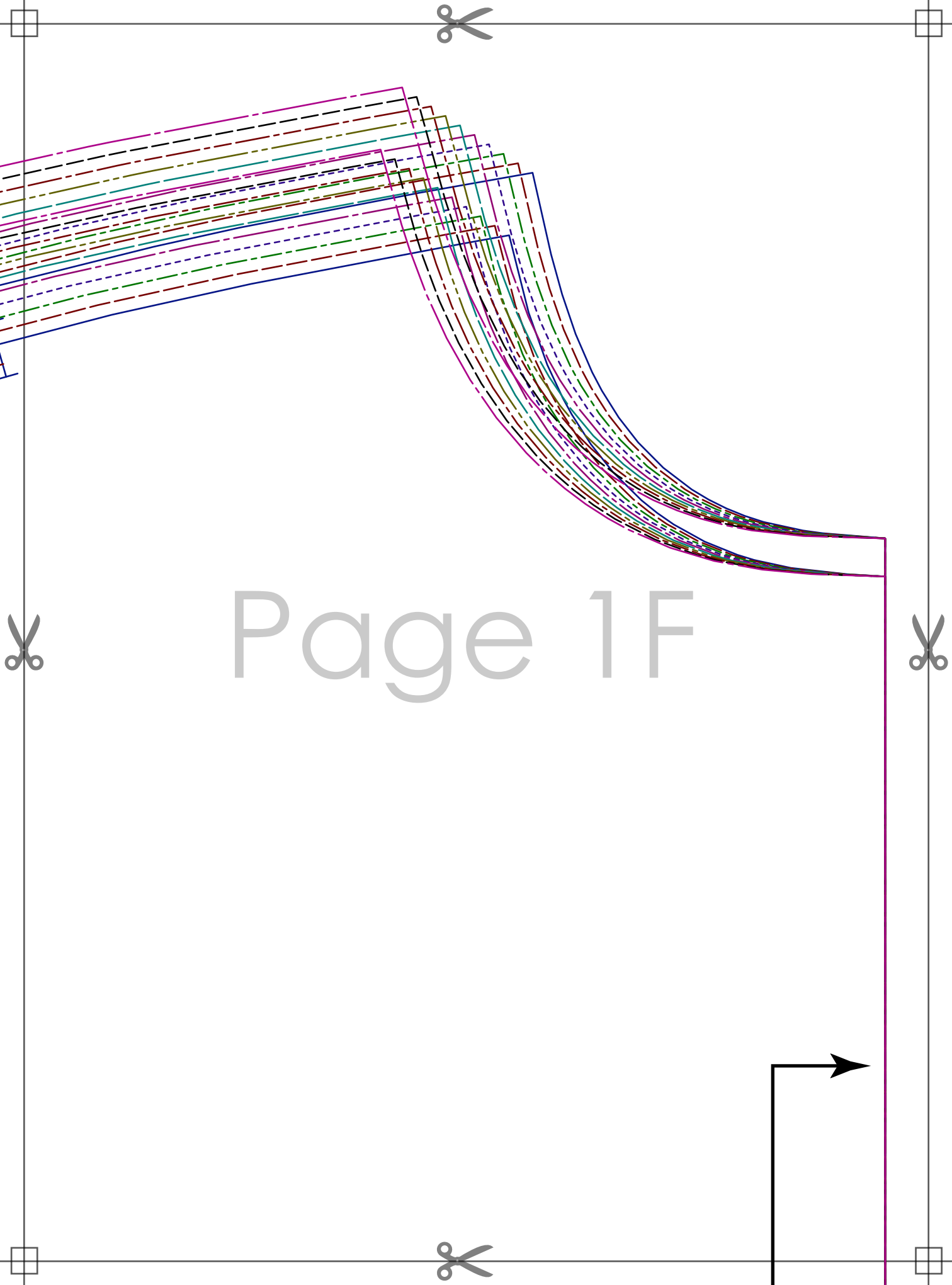

Page 1F



AMY BATWING TOP
with seam allowance

Size: ~~M~~ S

BACK
cut 1 on fold

Page 2A

Grainline

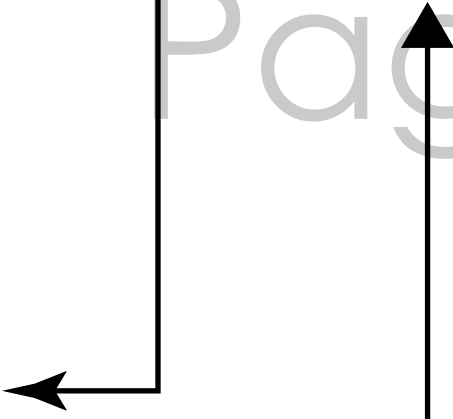



Page 2B

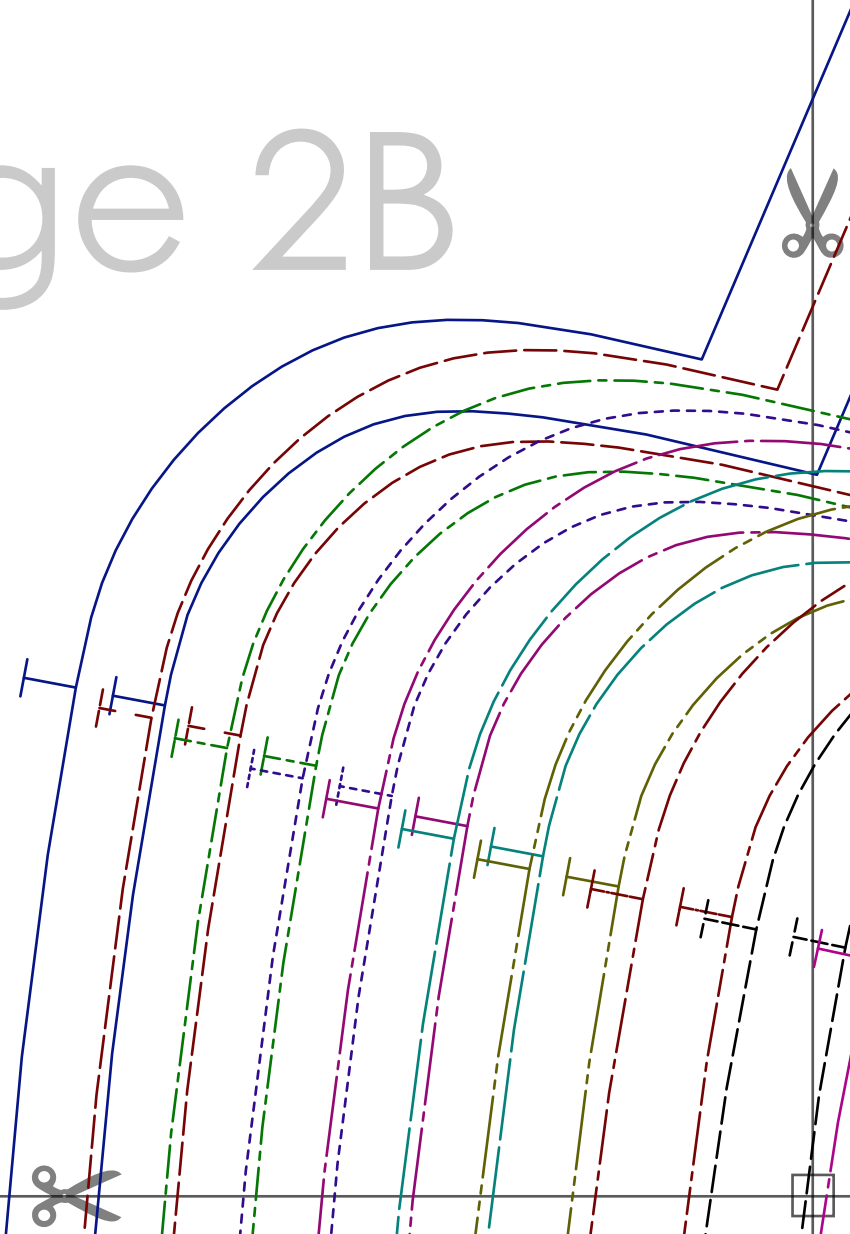
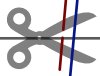

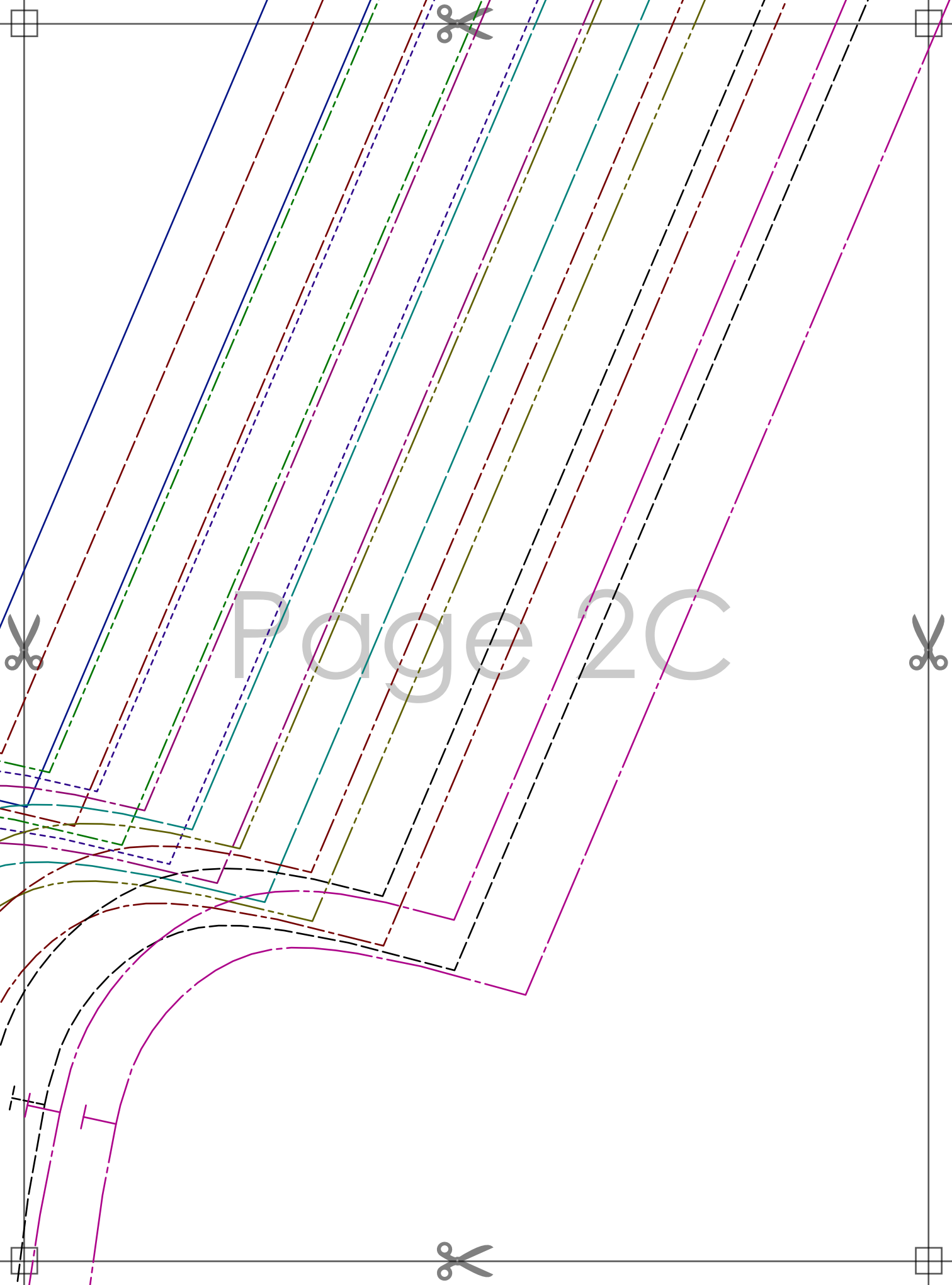

Page 2C

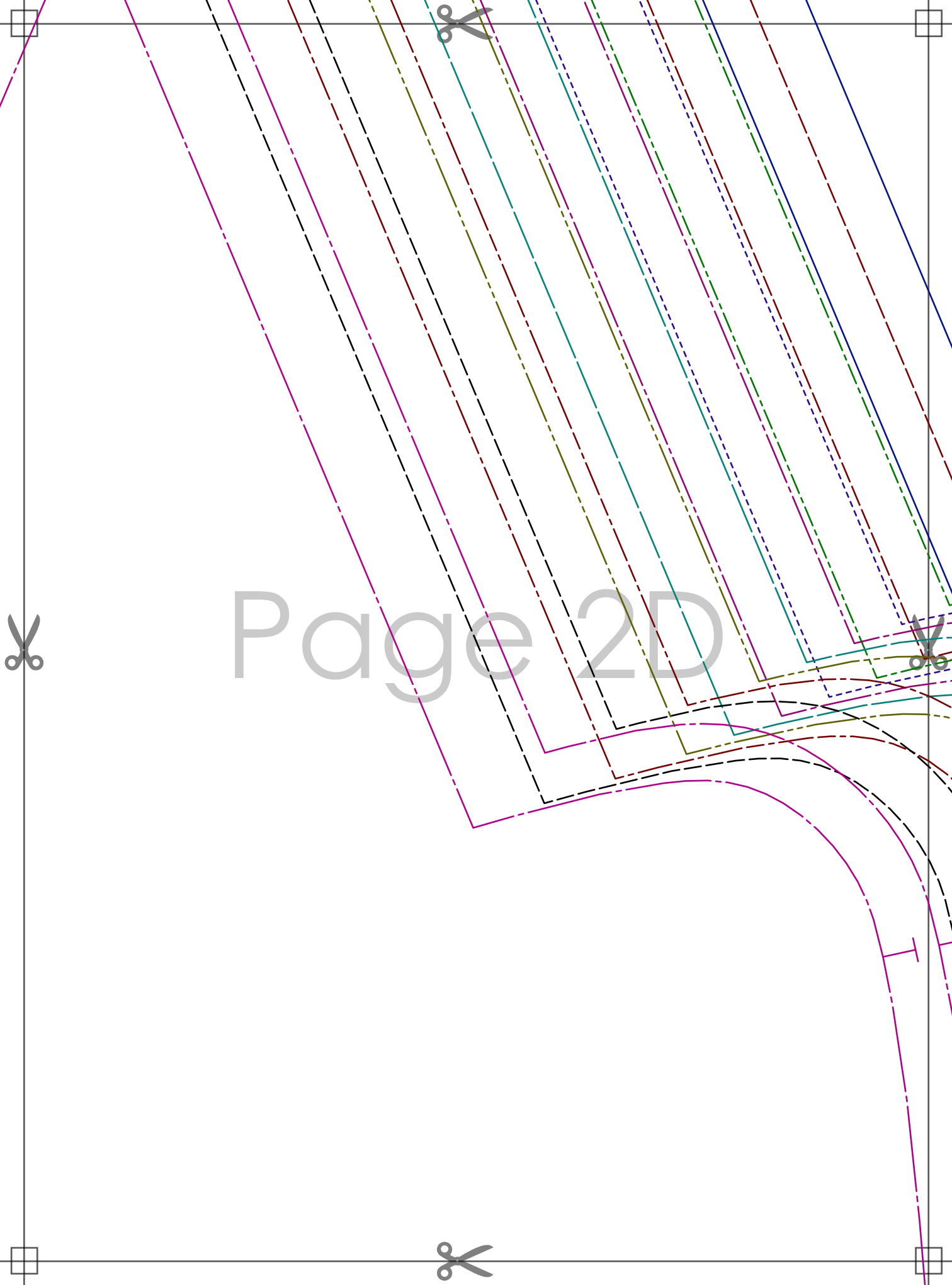

Page 2D

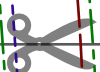

Page 2E

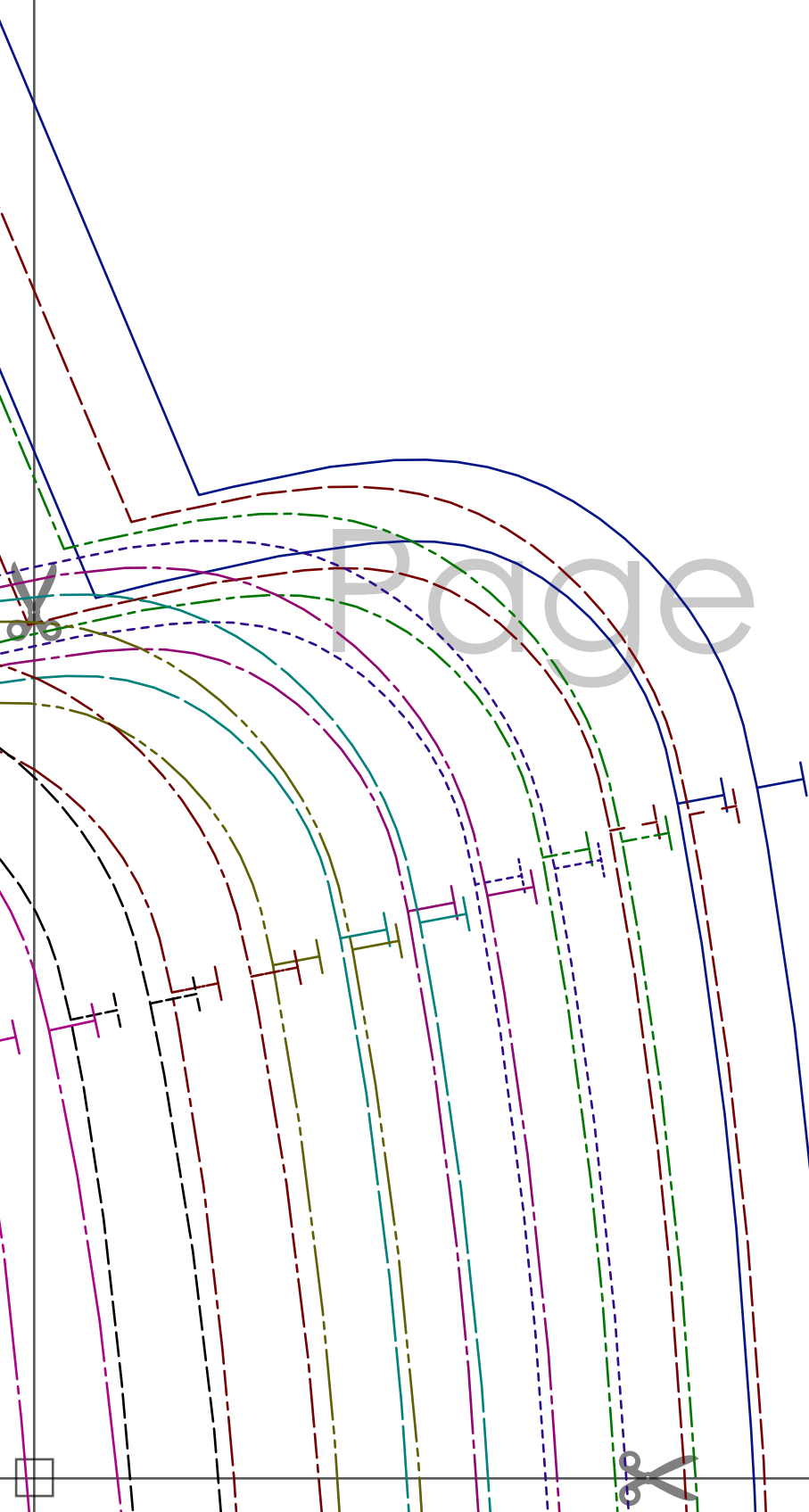



AMY BATWING TOP
with seam allowance

Size: ~~M~~ S

FRONT
cut 1 on fold

Page 2F

Grainline



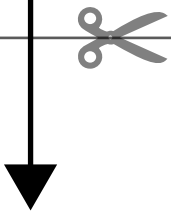

Page 3A



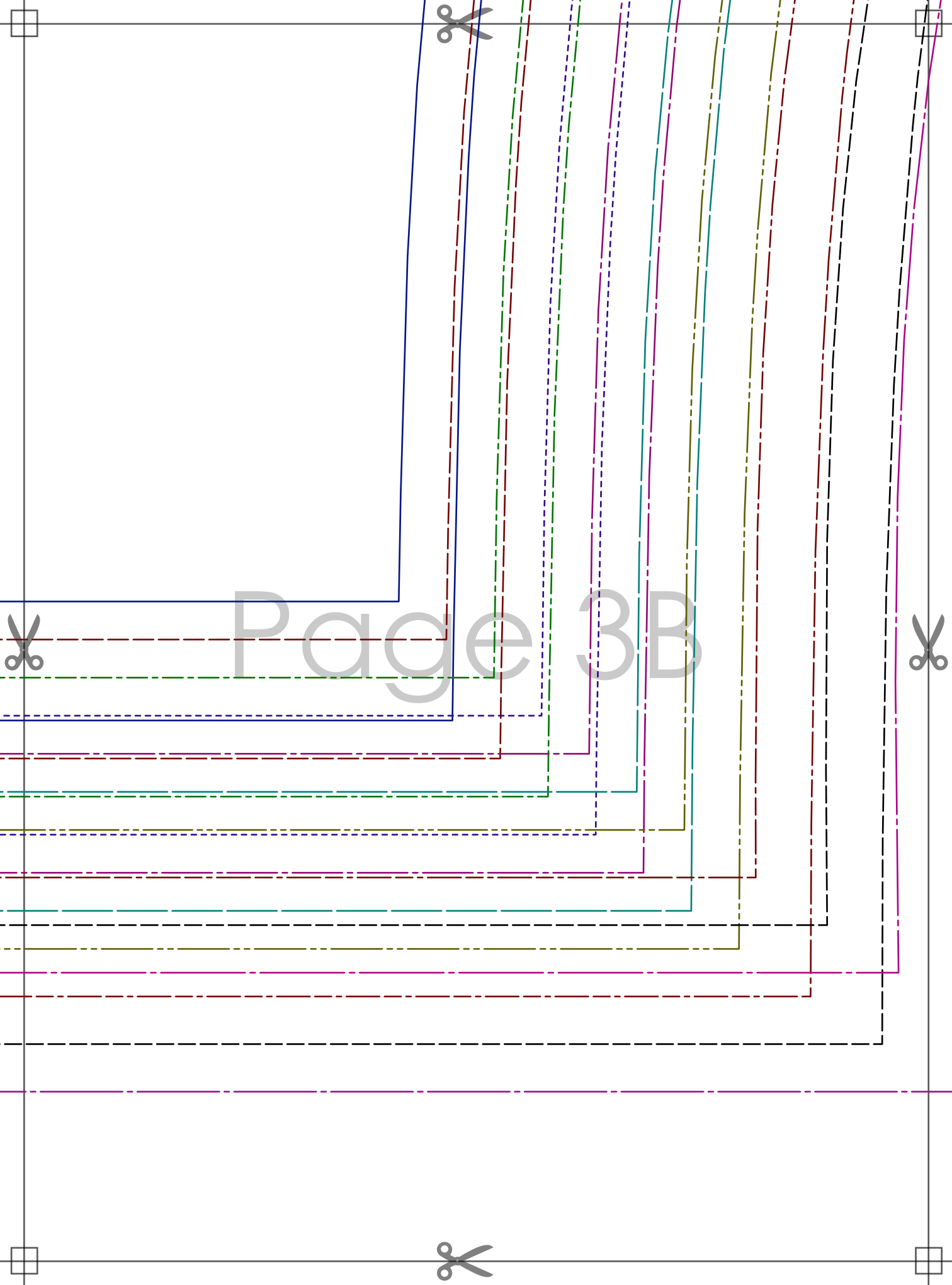

Page 3B

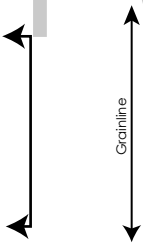
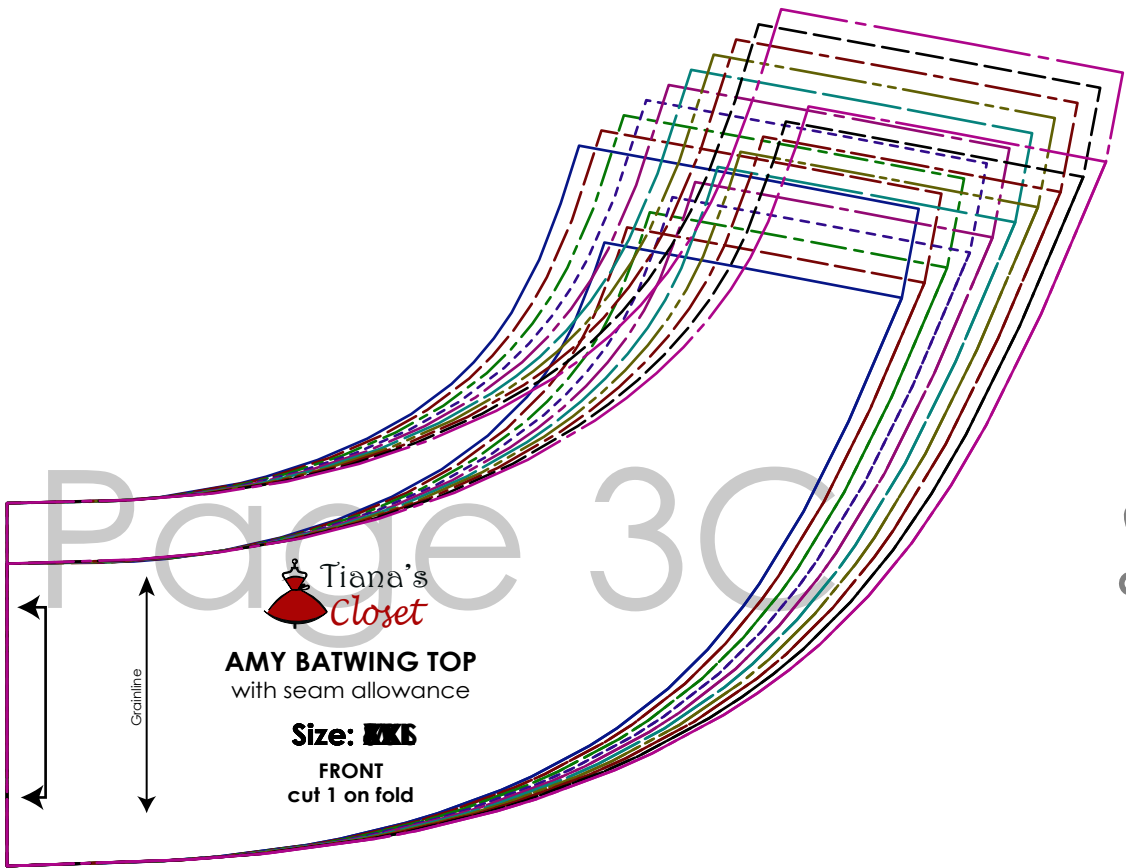
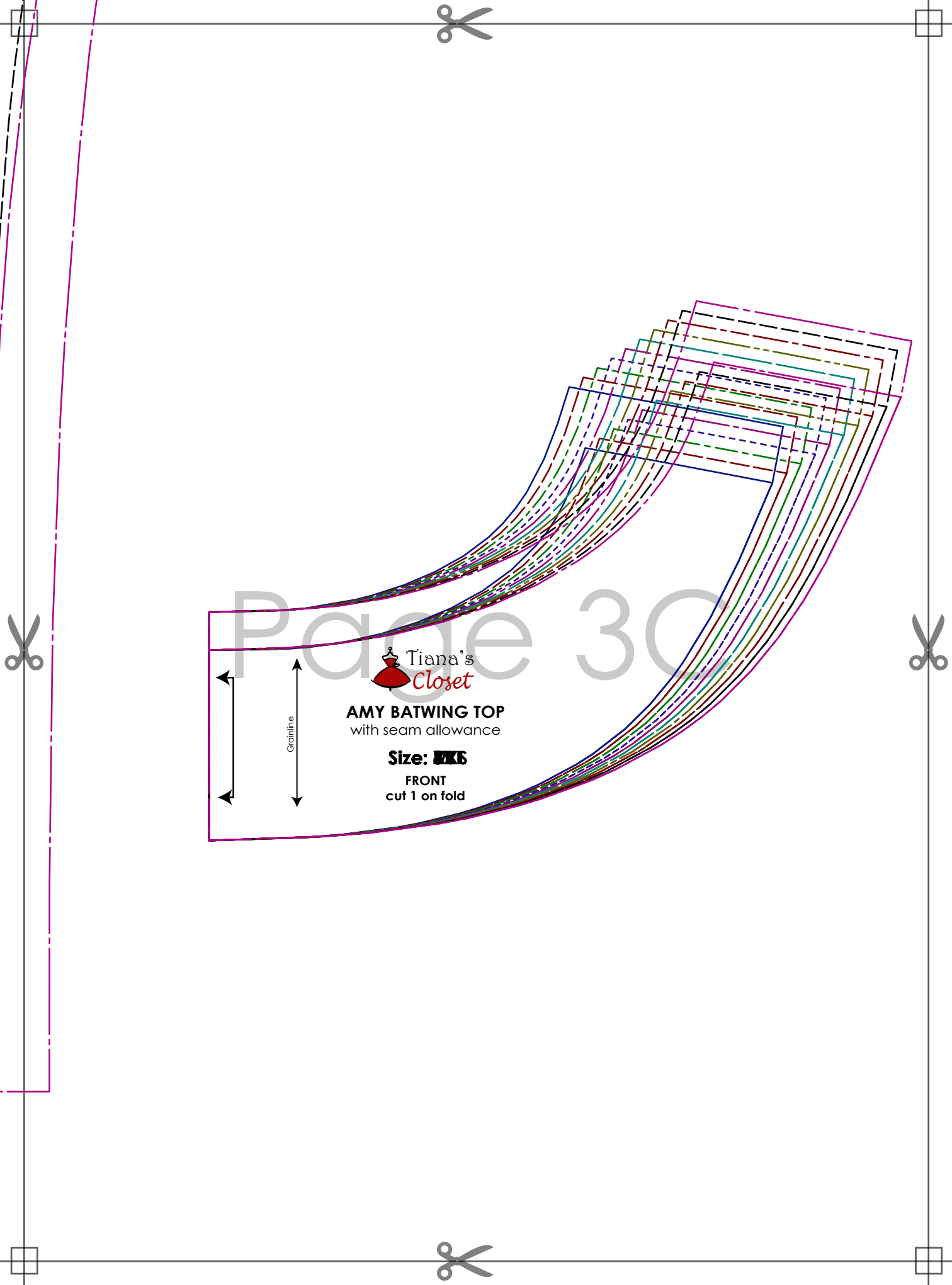

Tiana's
Closet

AMY BATWING TOP
with seam allowance

Size: ~~M~~L

FRONT
cut 1 on fold

Page 30

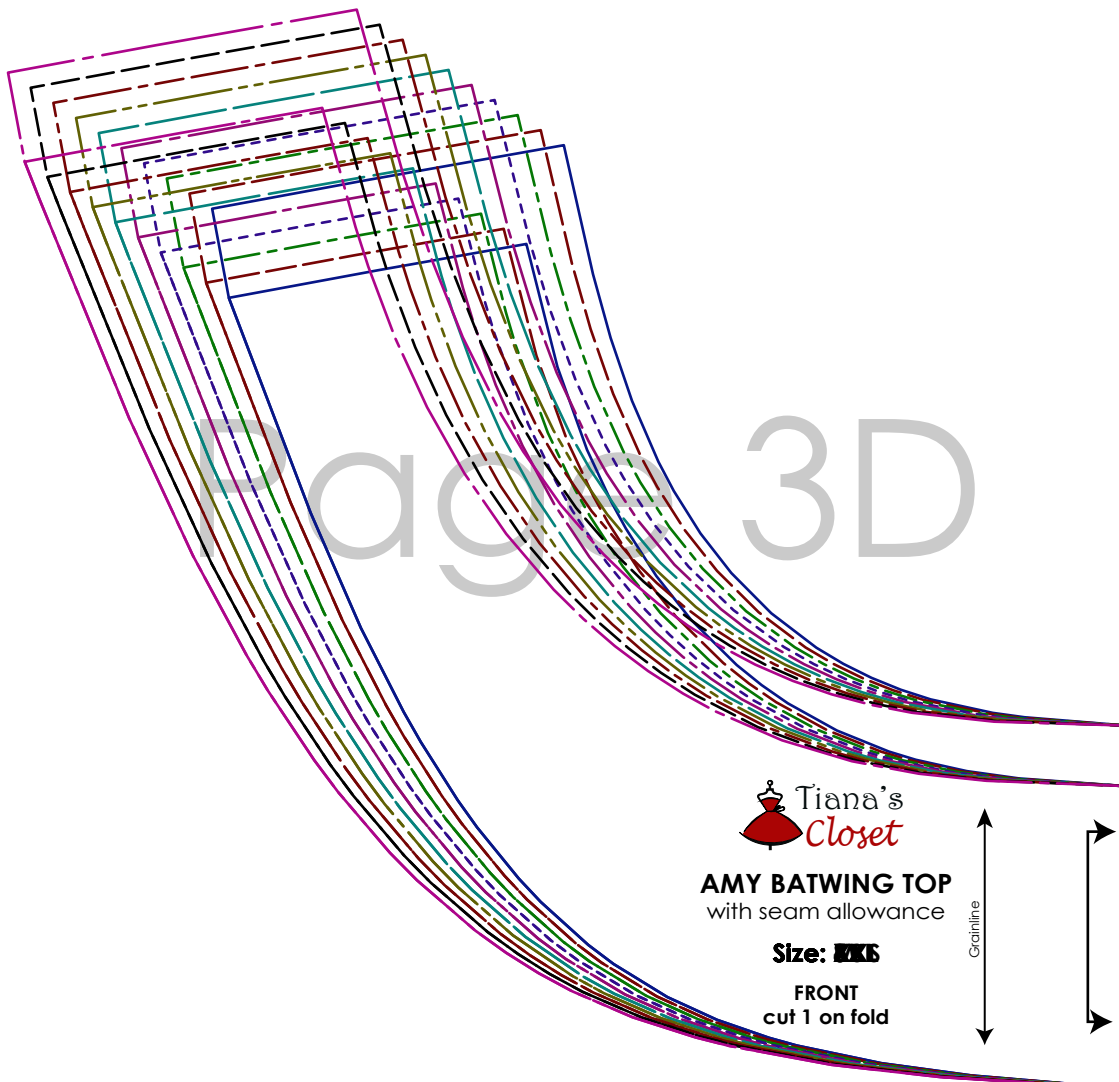

Page 3D



AMY BATWING TOP
with seam allowance

Size: ~~M~~ S

FRONT
cut 1 on fold

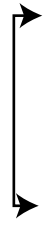

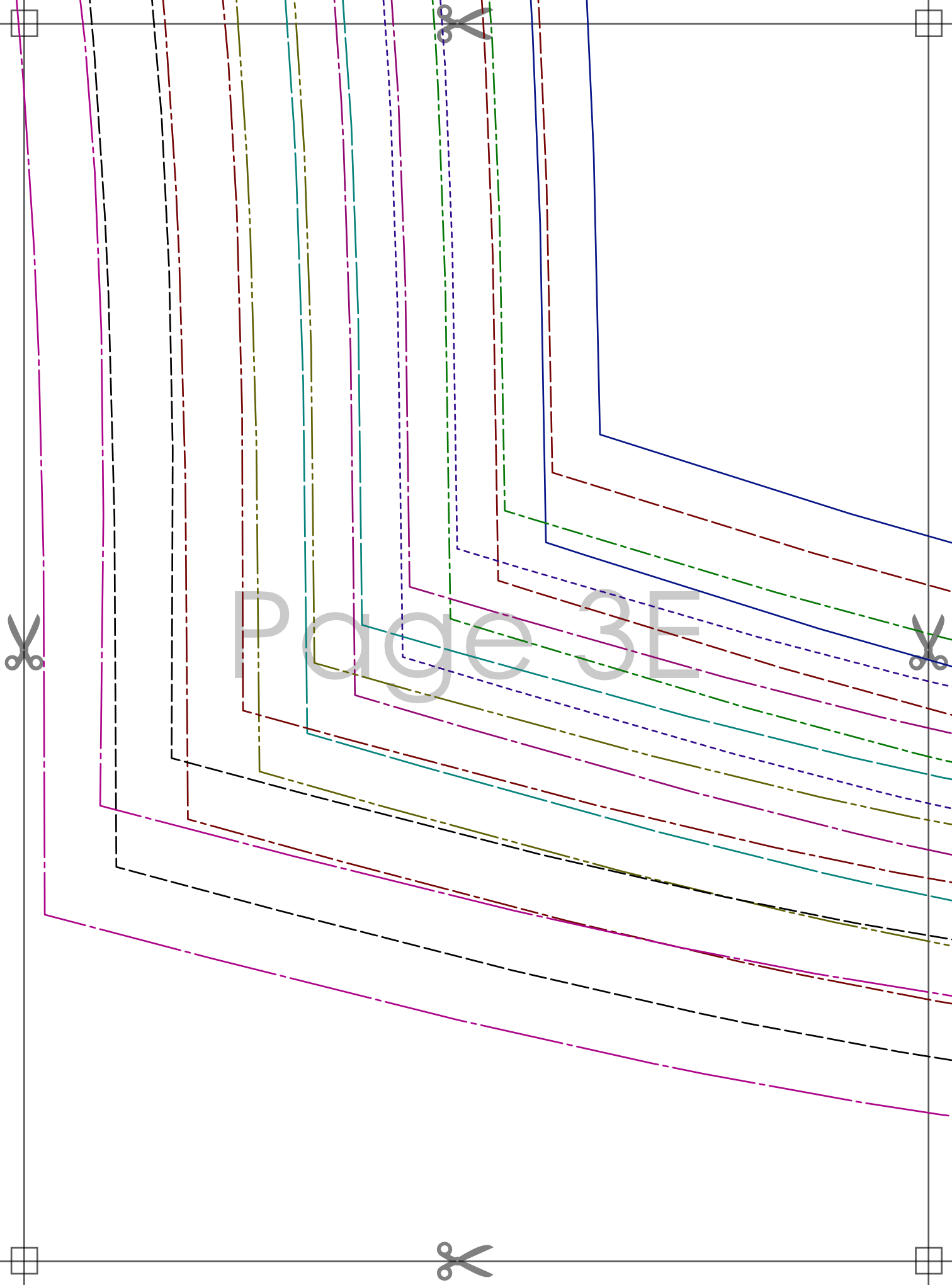



Page 3F

