

SIZE TABLE

KID'S CLOTHING SIZE

- Size is for body measurements, not finished garments.
- Size is based on body height, age is just approximate and may not be correct, please choose size according to kid's height. If kid is in the middle range, go up one size.

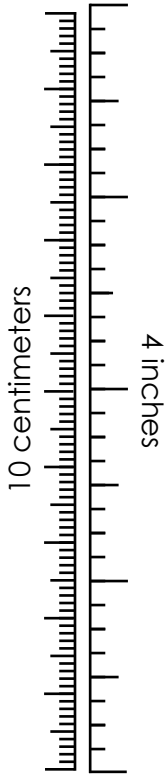

Size/Height (cm)	80	90	100	110	120	130	140	150	160
Approx age	12M	24M	3-4Y	4-5Y	6-7Y	8-9Y	10-11Y	12-13Y	14-15Y
Cross shoulder	22	23	24	26	28	30	32	34.5	37.5
Chest	50	53	56	59	63	67	71	75	79
Waist	47	50	53	56	59	62	66	70	74
Hip	54	57	60	64	68	72	76	80	84

Size	80	90	100	110	120	130	140	150	160
Height (inch)	31.5	35.4	39.4	43.3	47.2	51.2	55.1	59.1	63.0
Approx age	12M	24M	3-4Y	4-5Y	6-7Y	8-9Y	10-11Y	12-13Y	14-15Y
Cross shoulder	8.7	9.1	9.4	10.2	11.0	11.8	12.6	13.6	14.8
Chest	19.7	20.9	22.0	23.2	24.8	26.4	28.0	29.5	31.1
Waist	18.5	19.7	20.9	22.0	23.2	24.4	26.0	27.6	29.1
Hip	21.3	22.4	23.6	25.2	26.8	28.3	29.9	31.5	33.1

PRINTING INSTRUCTIONS

- Tiana's Closet sewing patterns are made in Layered PDF format, which means all sizes are saved in one file and can be shown or hidden. It is recommended to use Adobe Acrobat Reader (paid version on Mac OS, free on Windows) or Foxit PDF Reader (free, works on Windows only) to read the file correctly. In order to choose the desired size(s), go to Layers tab of your PDF reader, uncheck all boxes except for the desired size(s) and the box Print for all sizes.

- When printing the pattern, go to Print settings, in the tab Scale choose Custom scale: 100% (or Scaling: None or Actual Size) to print true to size. Note: some computers print smaller than true size even when you choose 100% scale, so you will have to adjust the scale to a little larger than 100% and measure the test square until you get the true size using the test rulers

- Always print the first page of the file and measure to avoid waste of paper.

- After printing the pattern, cut the pages along the lines with scissors icon, align and tape the pages according to their sequences. For example, pages 1A, 1B, 1C, 1D... are line up in one row from left to right, pages 1A, 2A, 3A, 3B... are lined up in one column from up to down.

- You can find photo instruction for printing sewing patterns on Tiana's Closet website: <https://tianascloset.com/index.php/how-to-print-tianas-closet-patterns/>

PATTERN LAYOUT

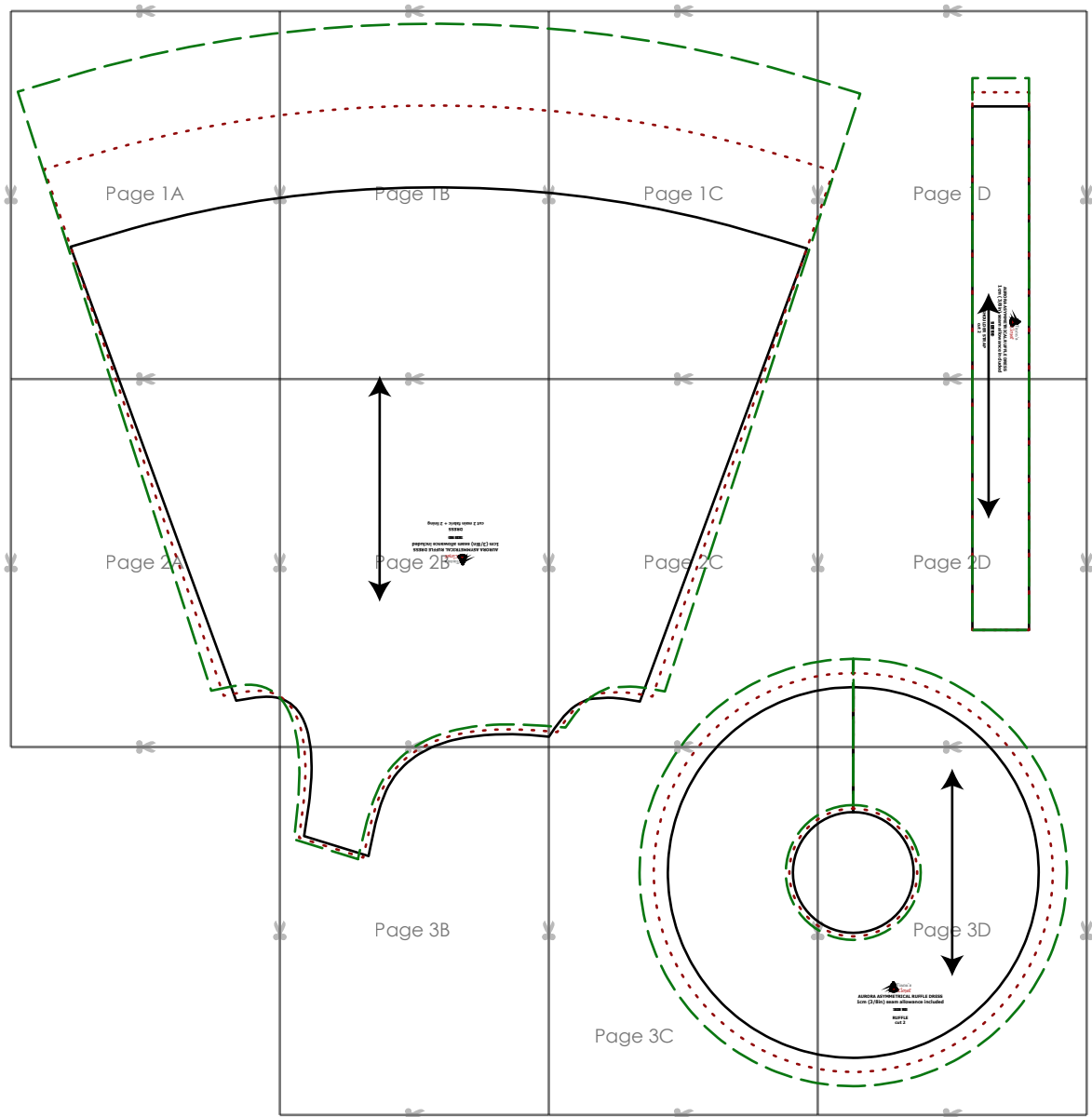

LEGEND

SIZE 80



SIZE 90



SIZE 100



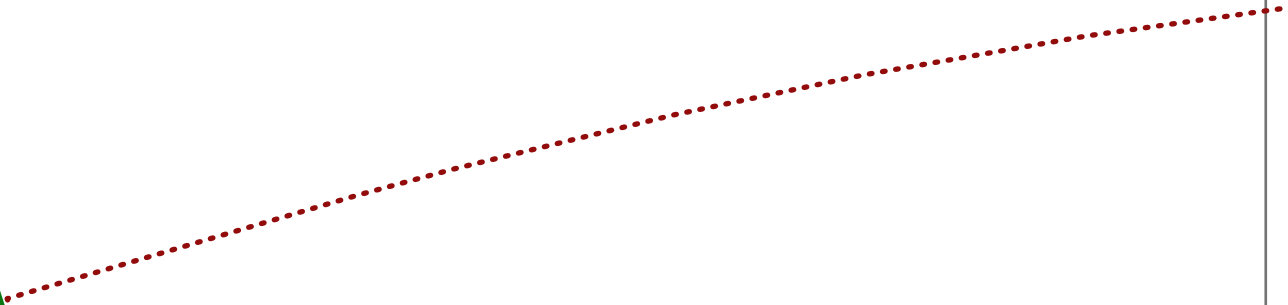
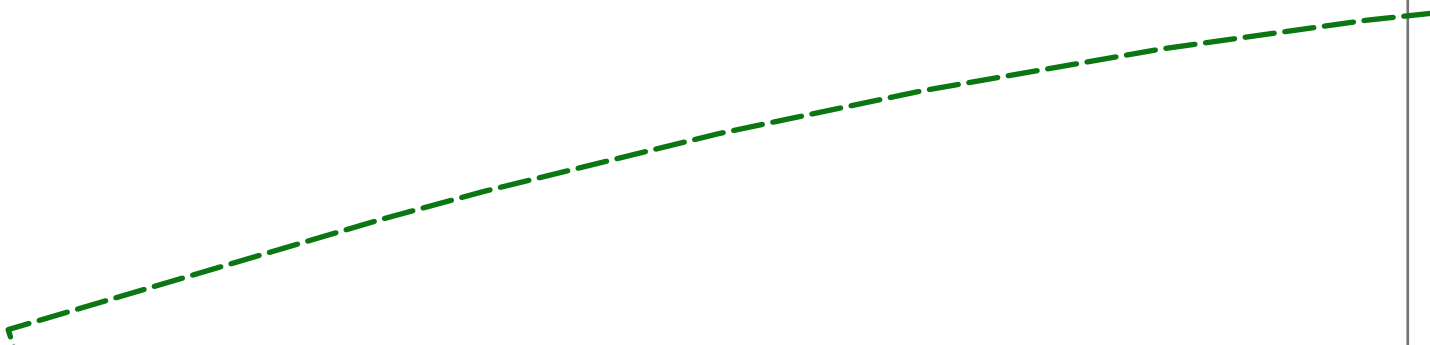

Page 1A



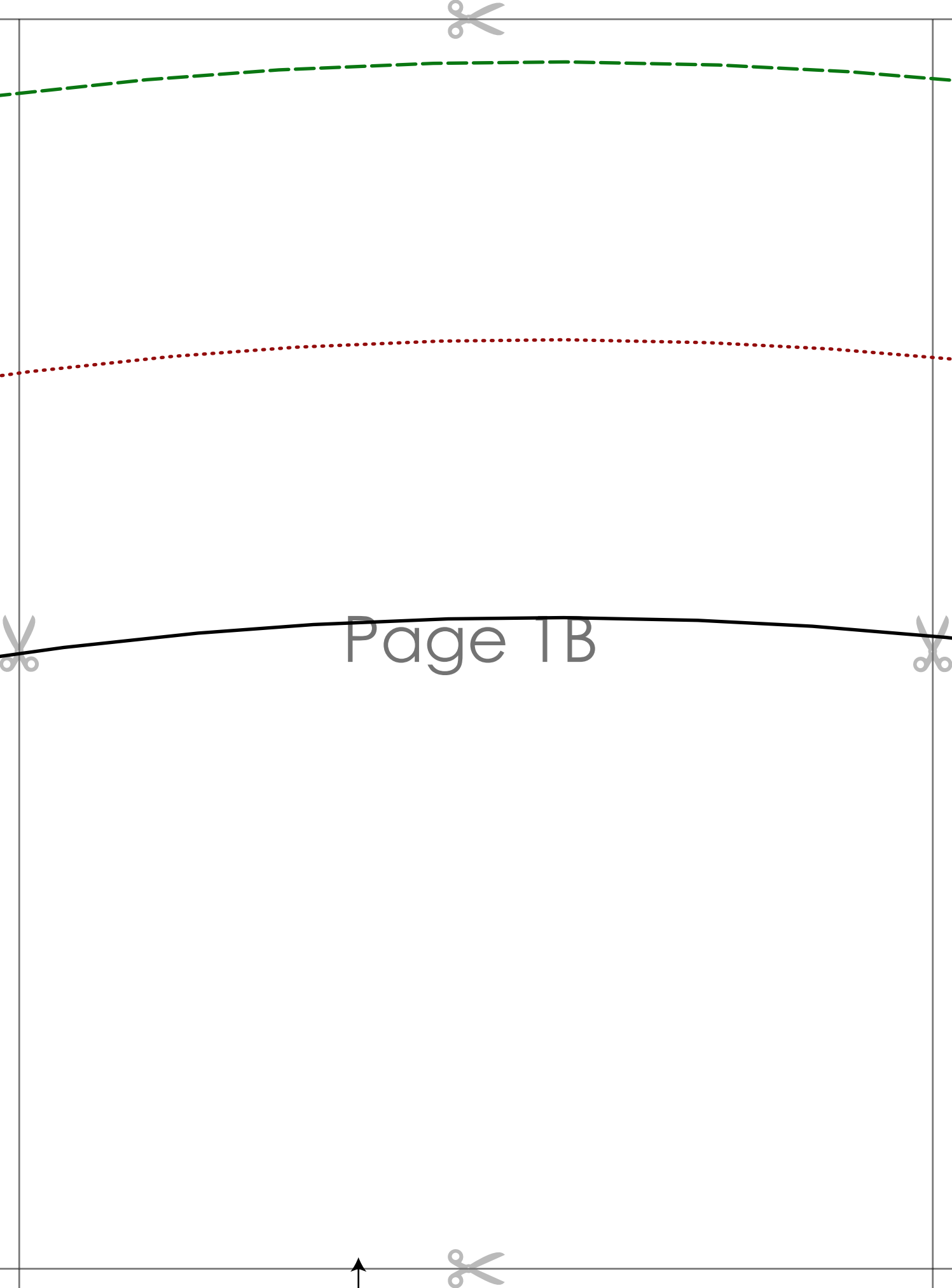

Page 1B



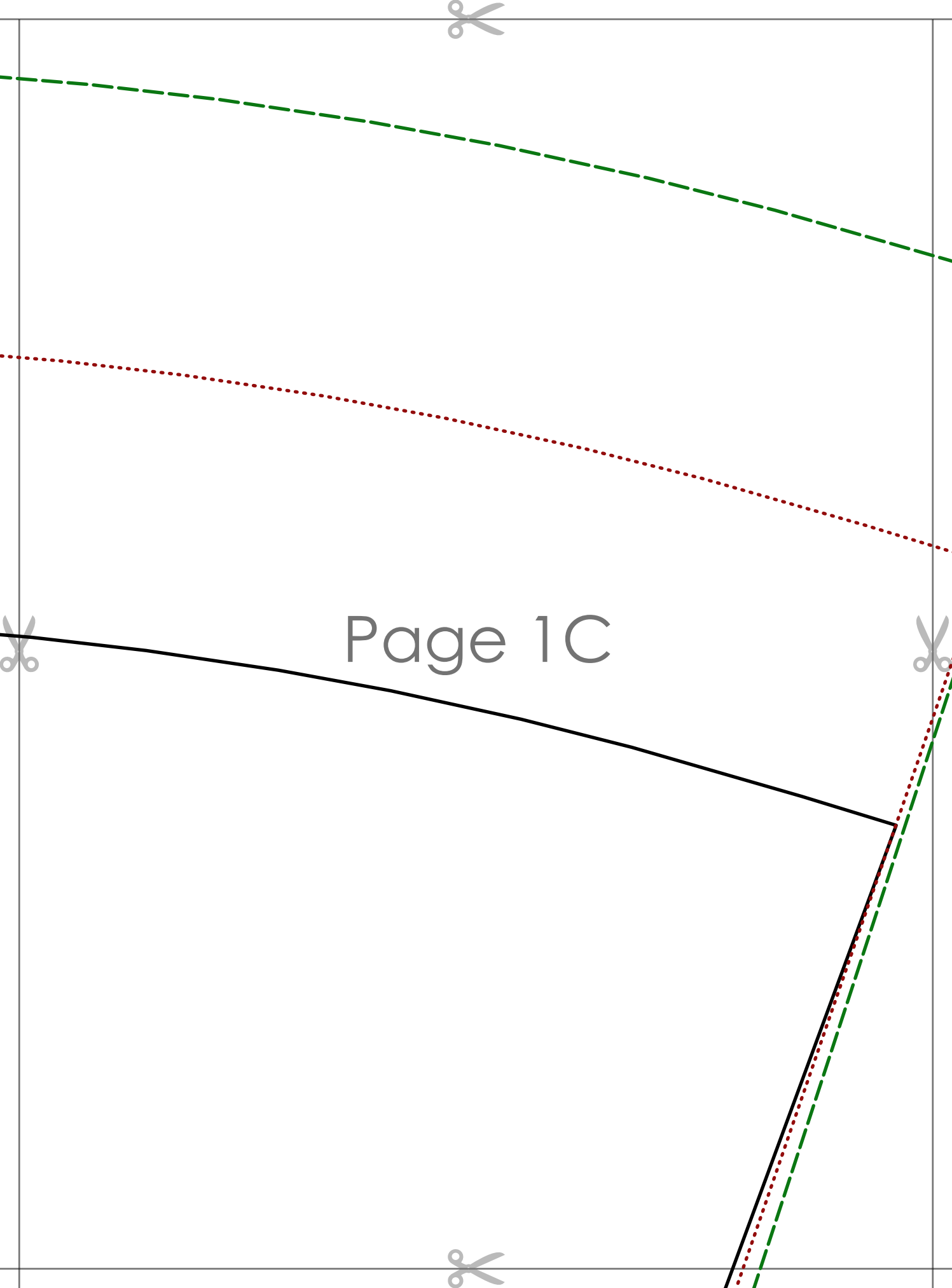

Page 1C



Page D

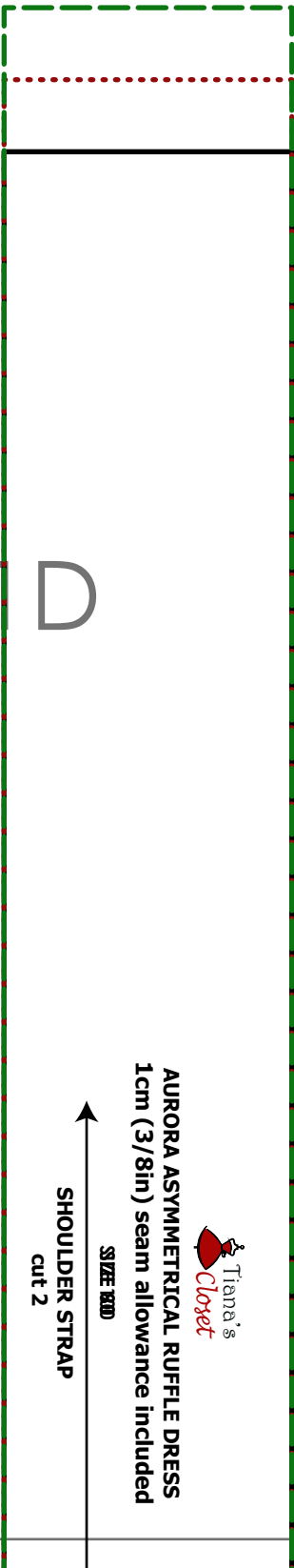
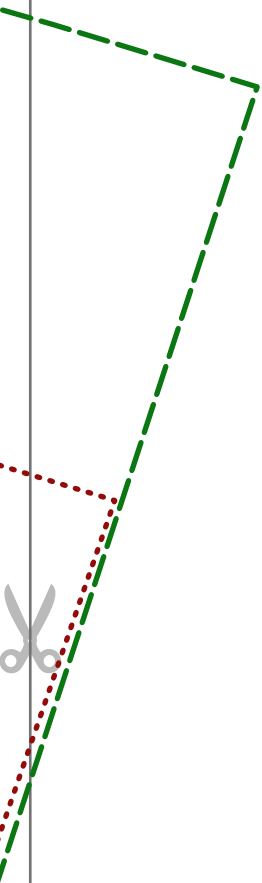

AURORA ASYMMETRICAL RUFFLE DRESS
1cm (3/8in) seam allowance included



SIZE: **80D**

SHOULDER STRAP

cut 2



Page 2A



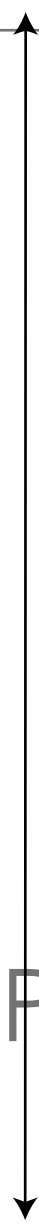

AURORA ASYMMETRICAL RUFFLE DRESS
1cm (3/8in) seam allowance included
SIZE 80D
DRESS
 cut 2 main fabric + 2 lining

Page 2B

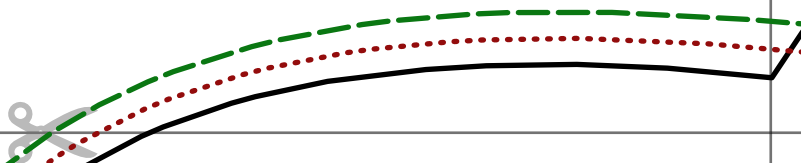
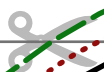
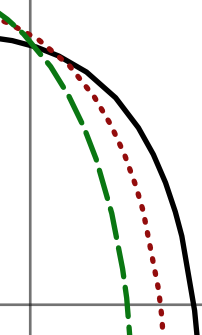

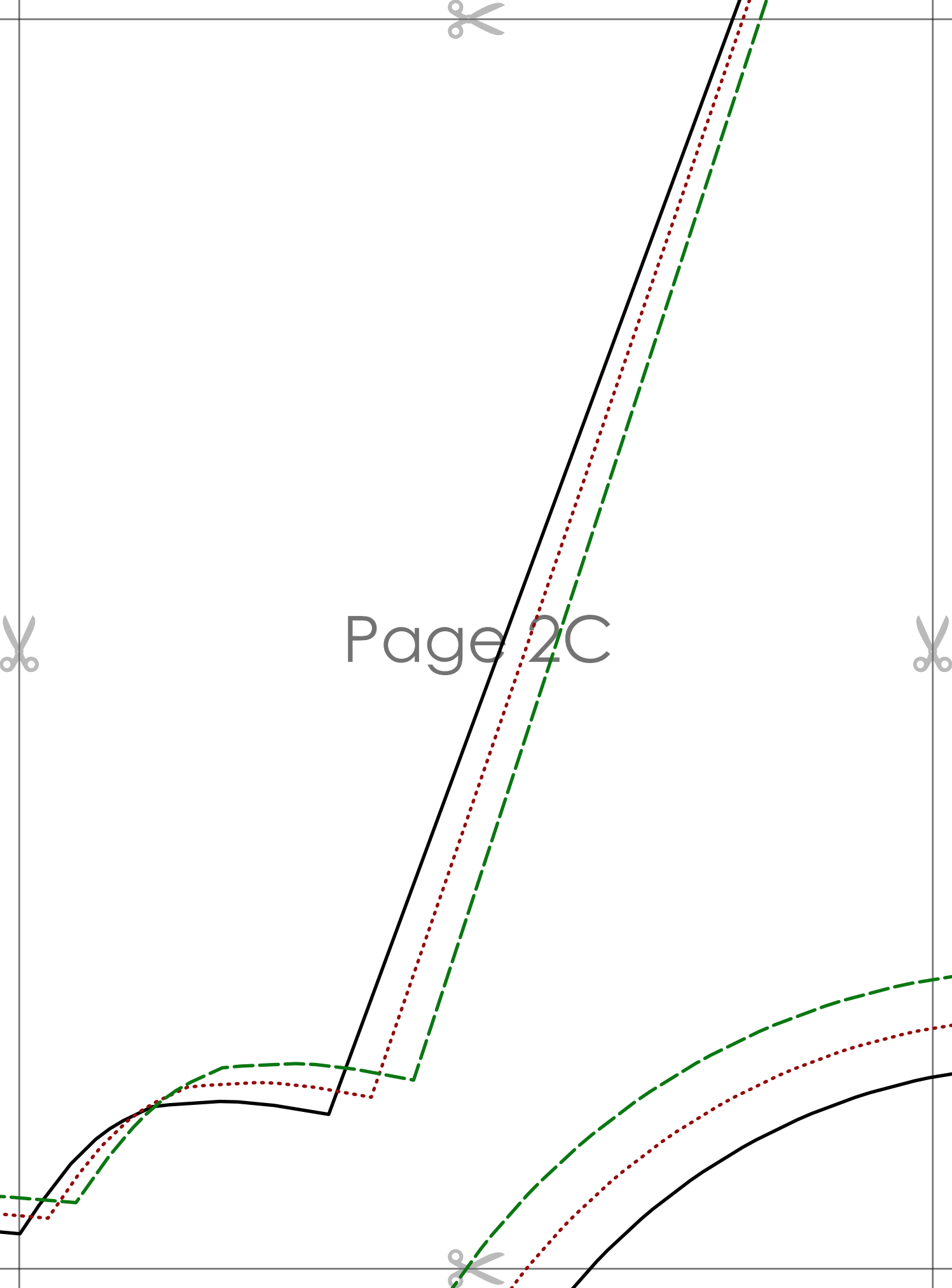

Page 2C



Page 2D

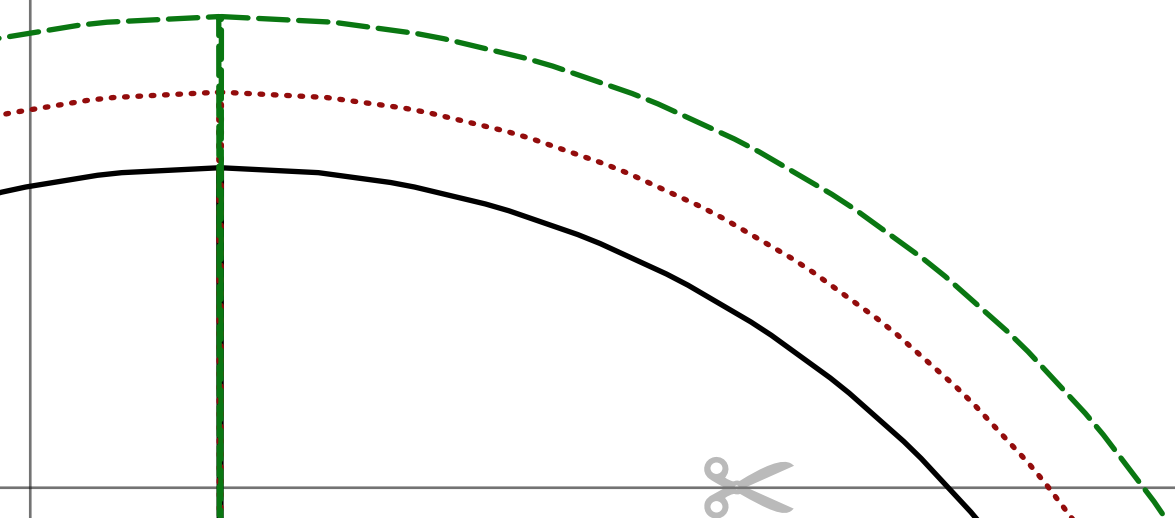

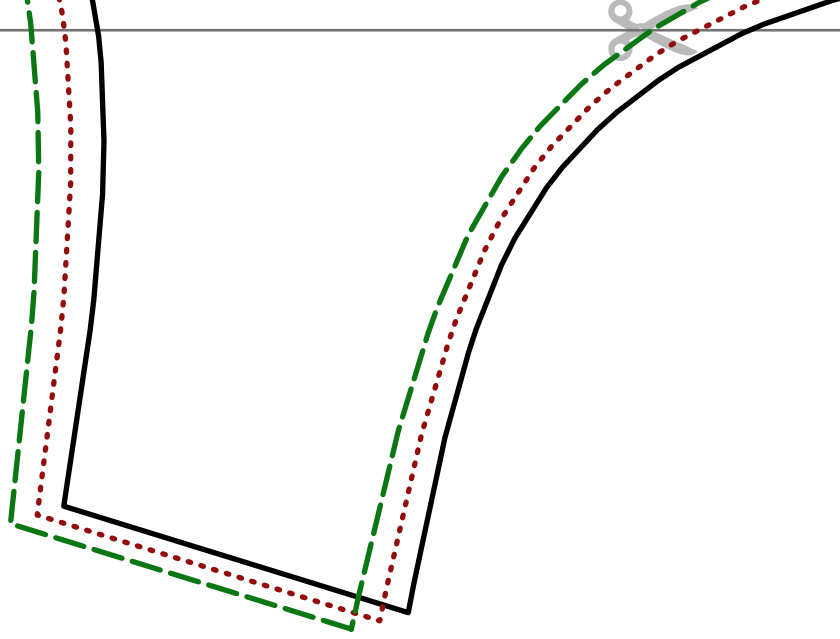

Page 3B



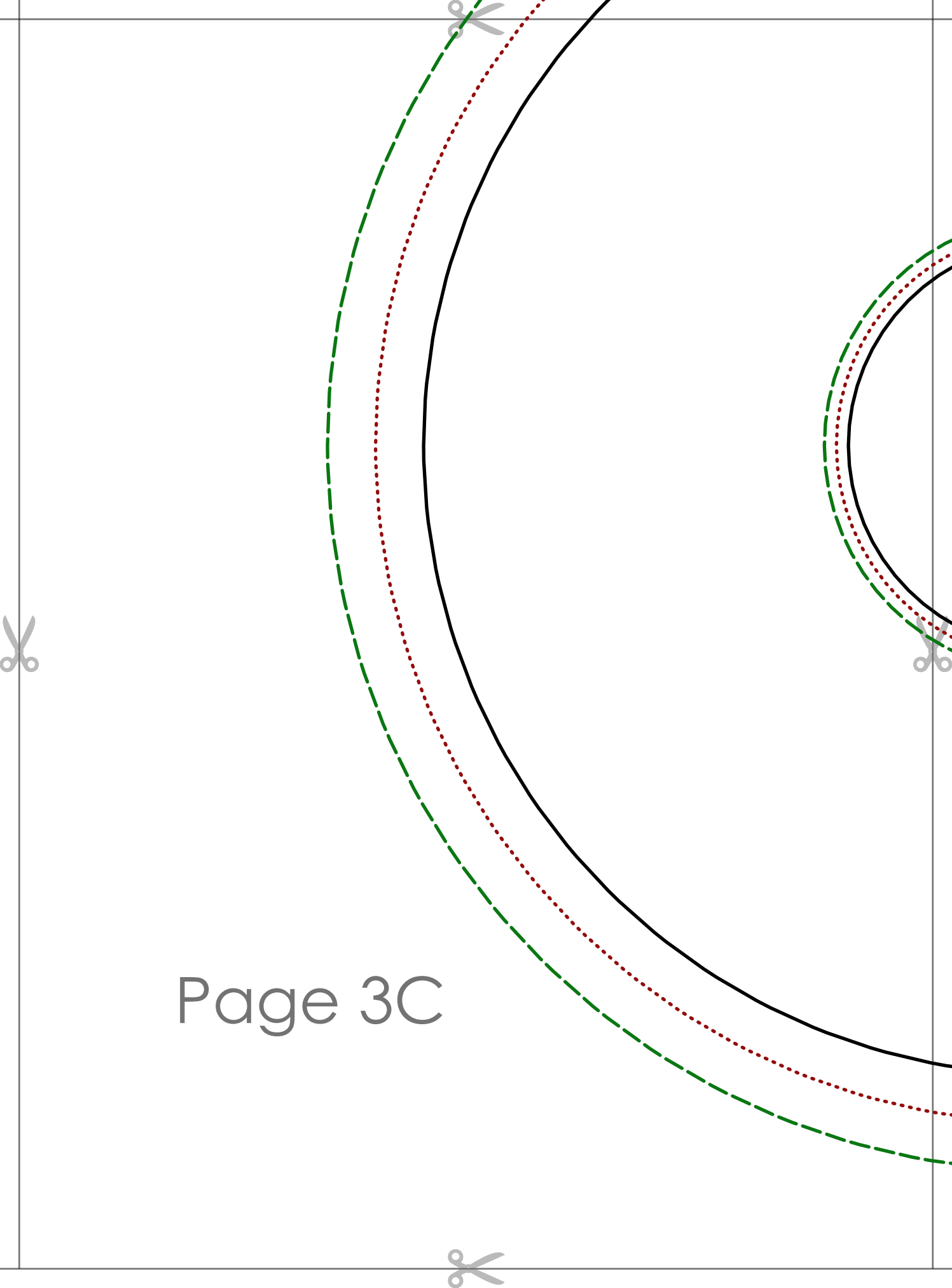

Page 3C

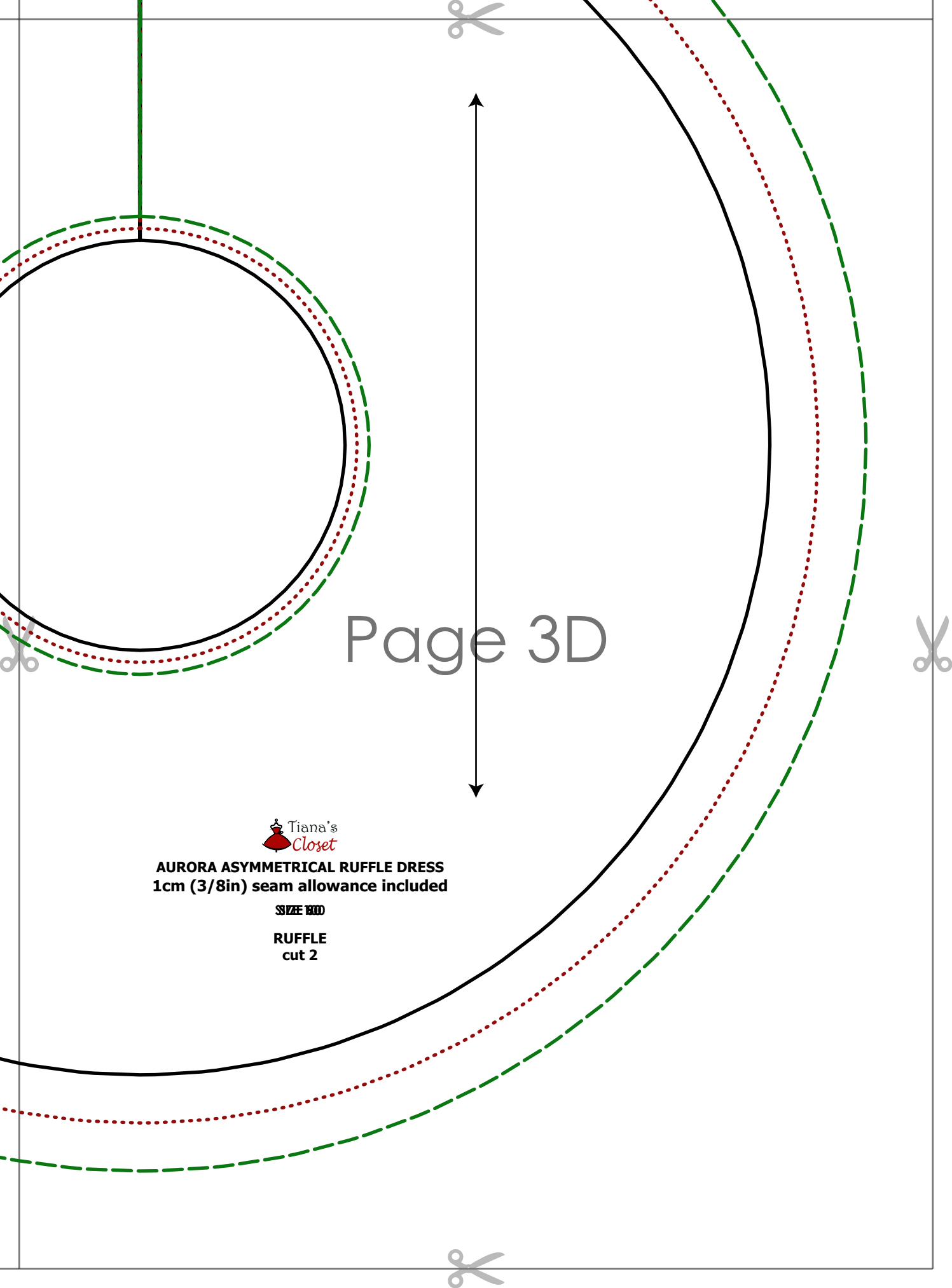

Page 3D



AURORA ASYMMETRICAL RUFFLE DRESS
1cm (3/8in) seam allowance included

SIZE 100

RUFFLE
cut 2