

Page 1A

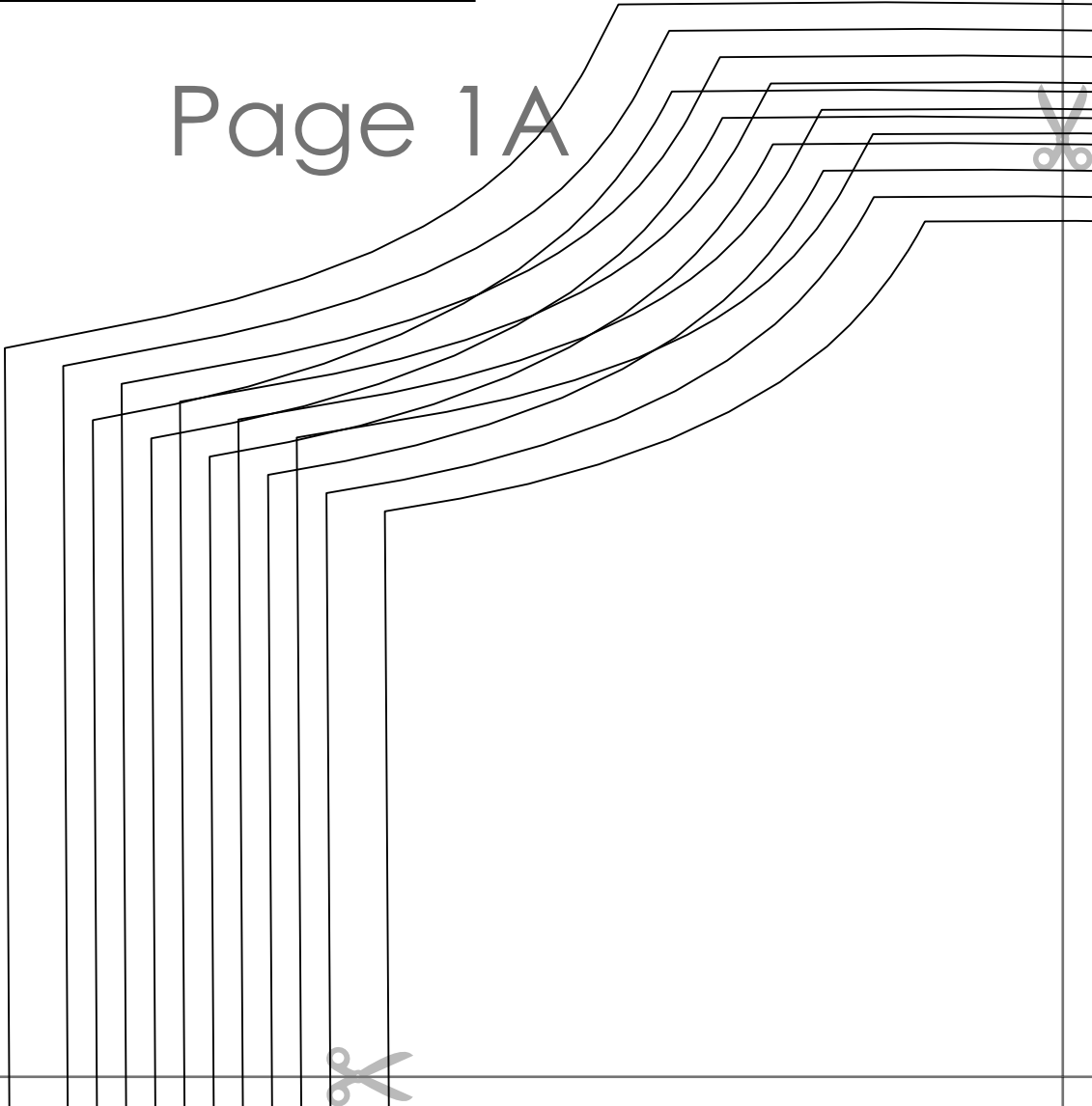

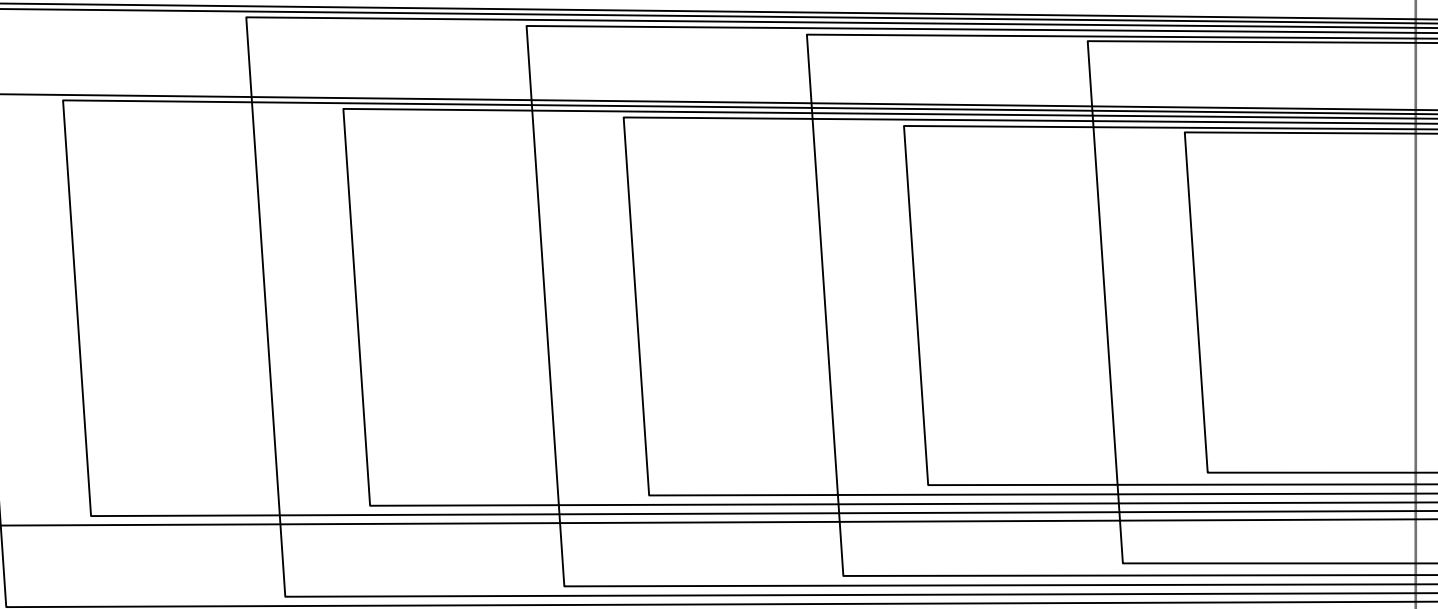

Page 1B



**KID'S JOGGER PANTS  
with seam allowance**

**SIZE 12**

**FRONT  
cut 2**

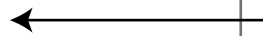

For more ideas and free sewing patterns, visit <http://tianascloset.com>





**KID'S JOGGER PANTS  
with seam allowance**

**SIZE 10**

**SIDE STRIPE  
cut 2**

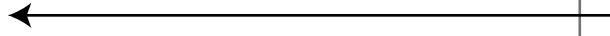

Page 1C

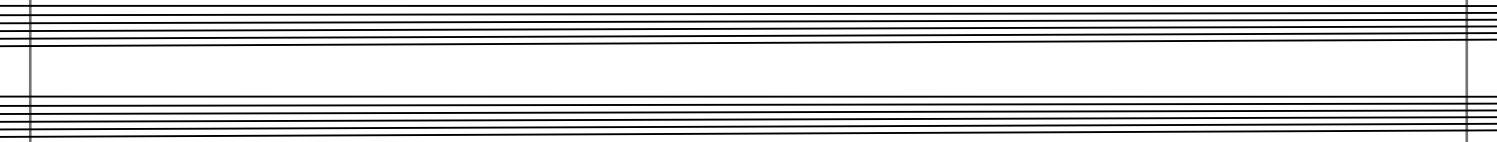
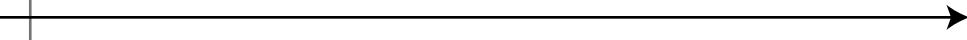
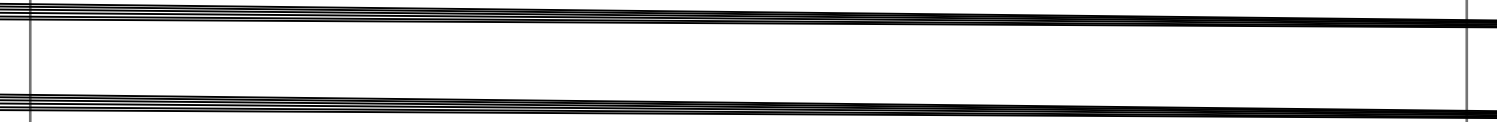

Page 1D

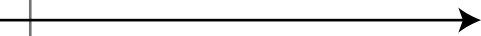
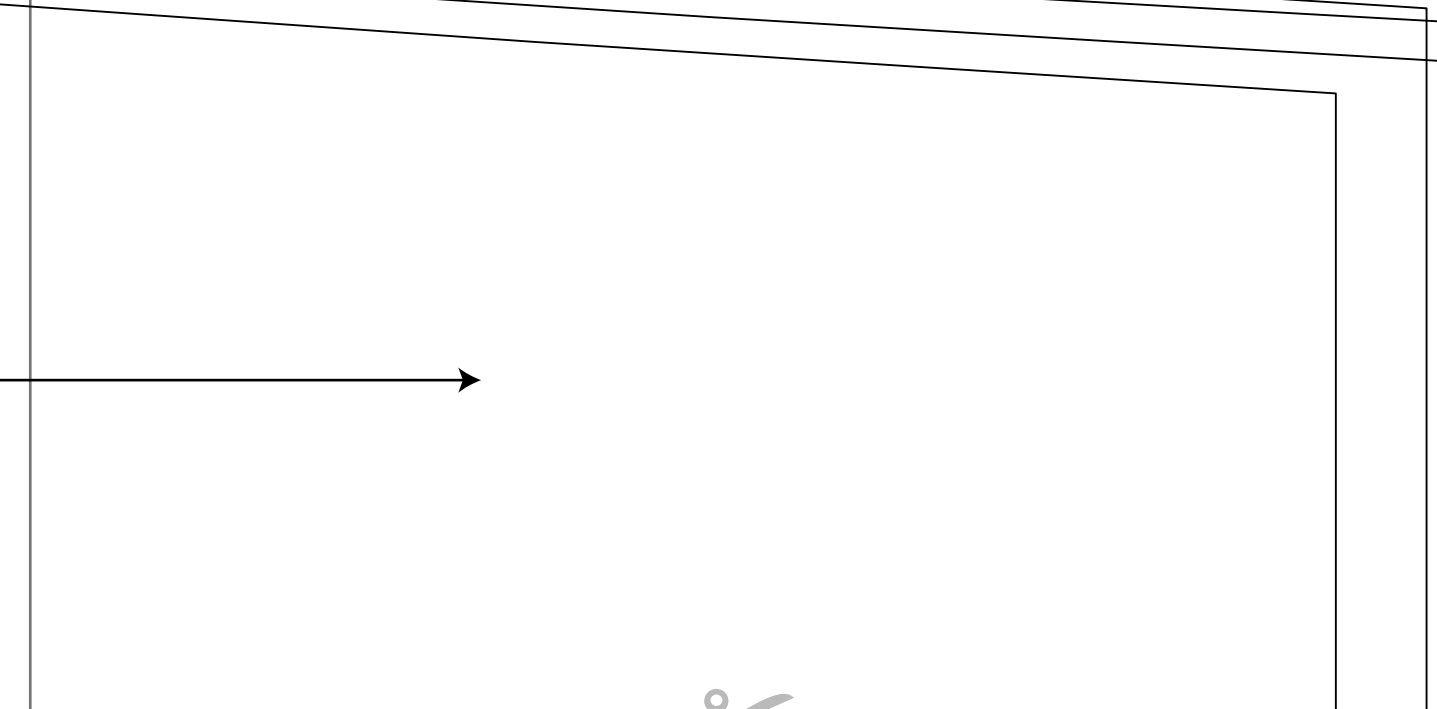
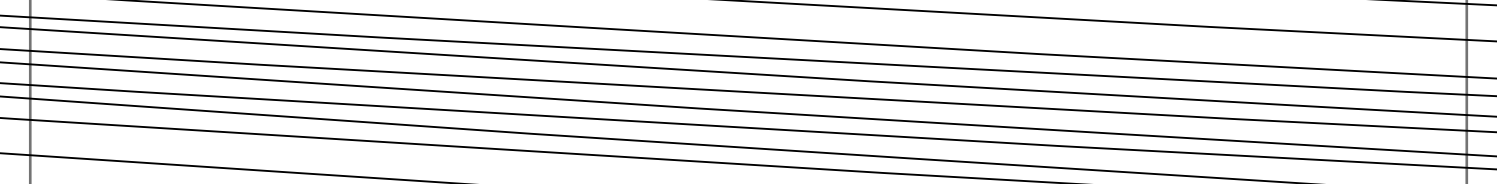

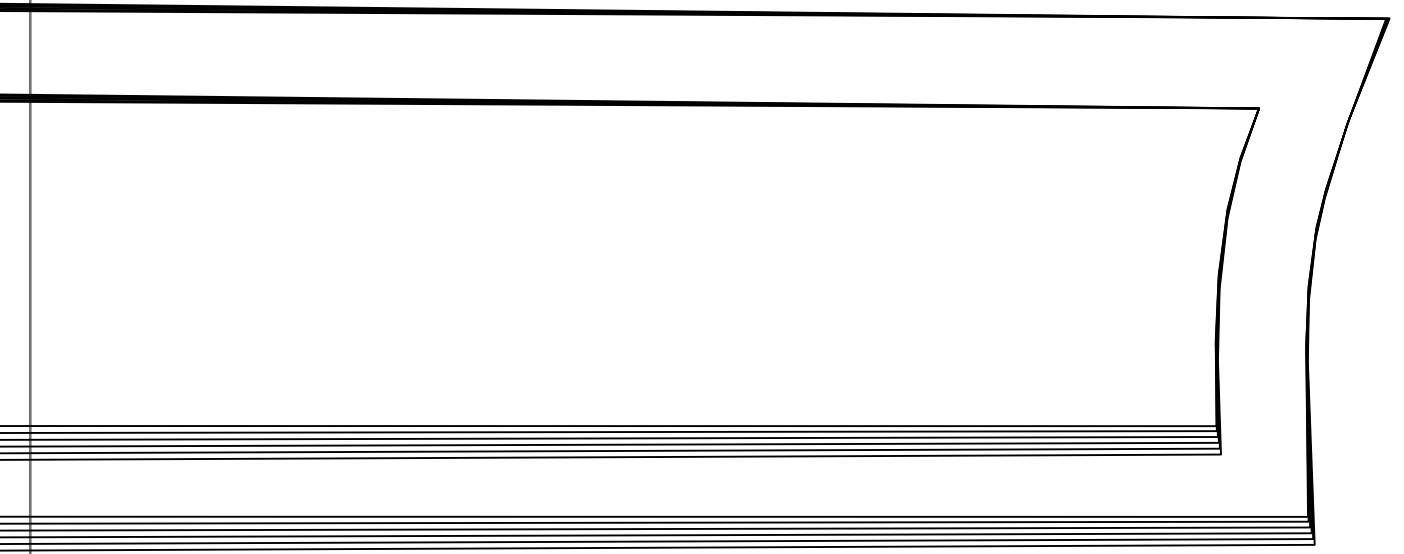

Page 1E

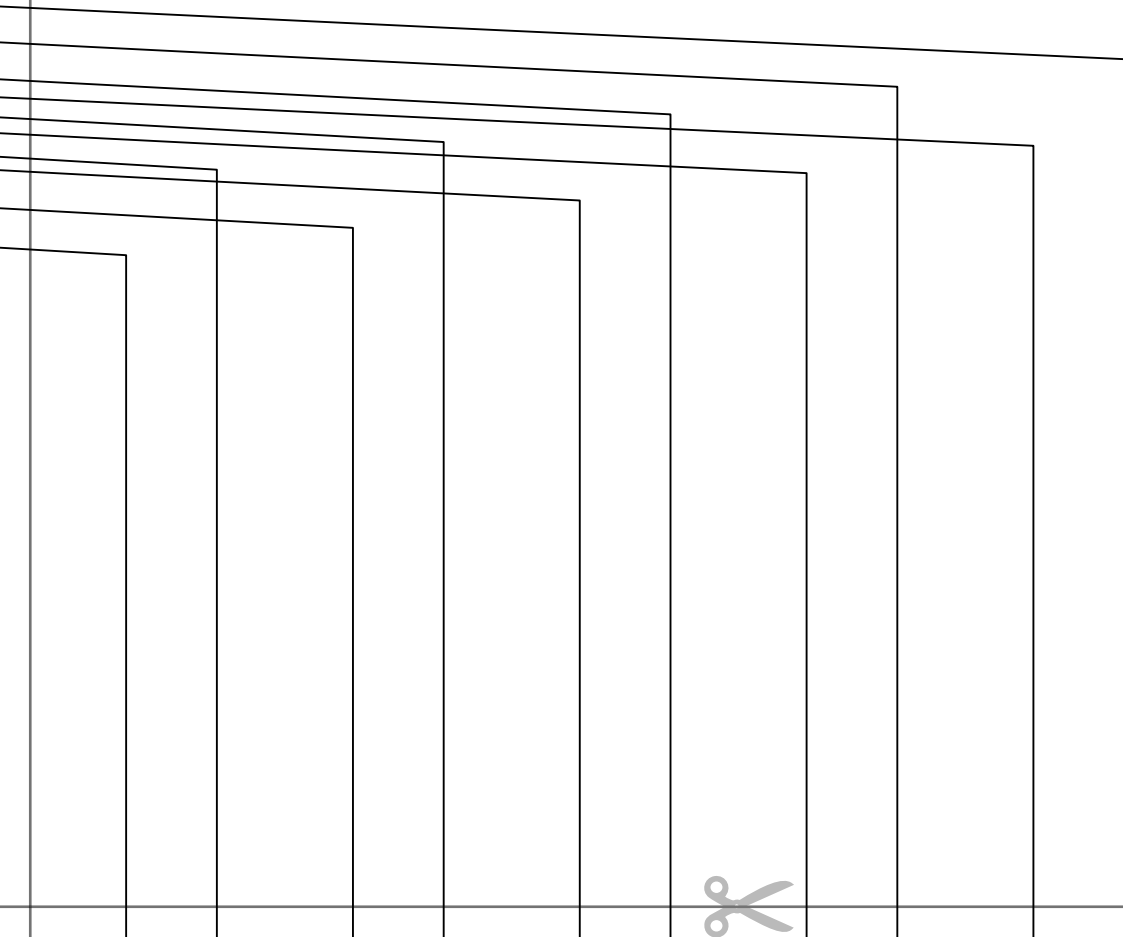

Page 2A



**KID'S JOGGER PANTS  
with seam allowance**

**SIZE 10**

**POCKET PIECE  
cut 2**

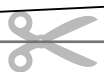
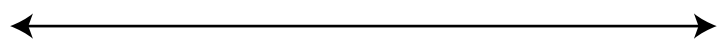

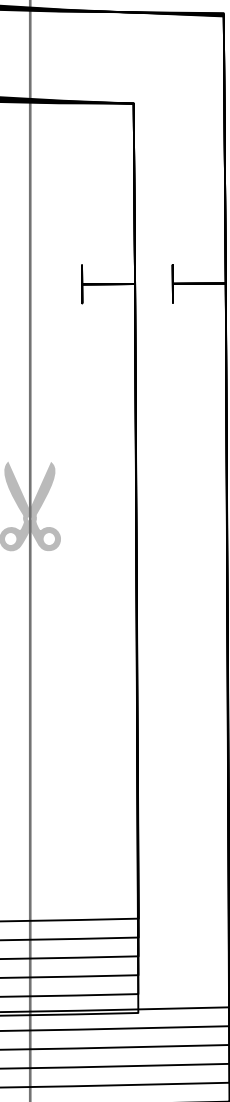
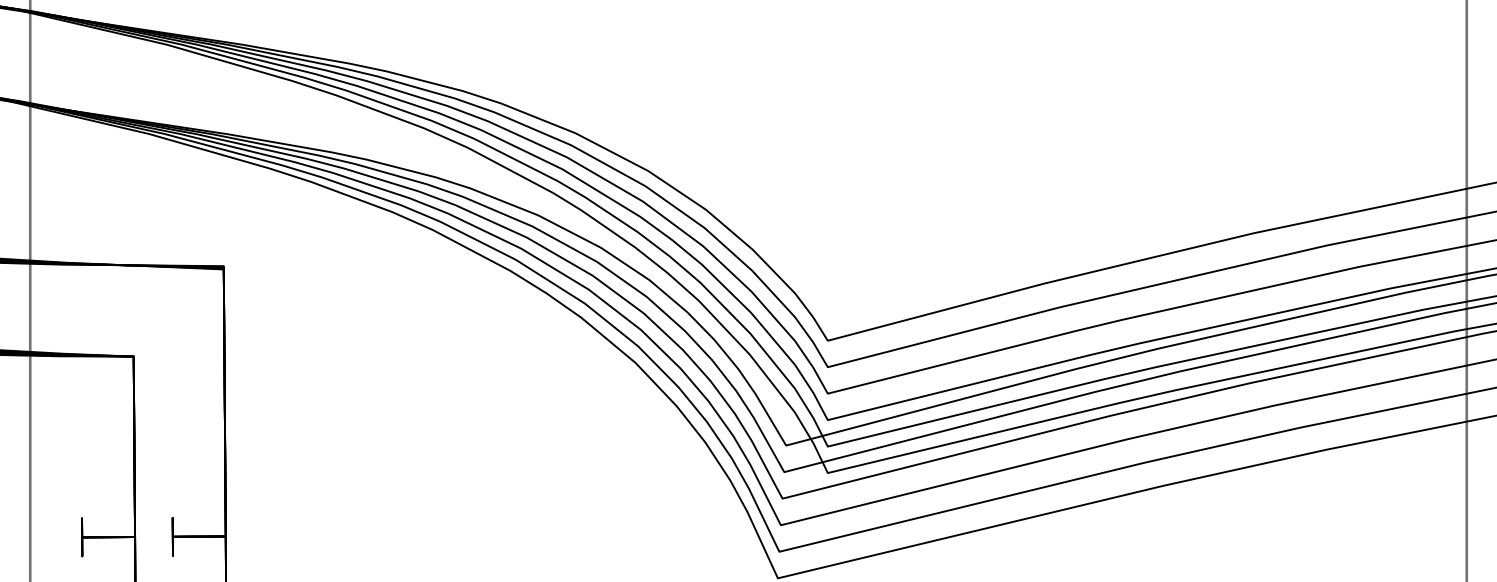

Page 2B

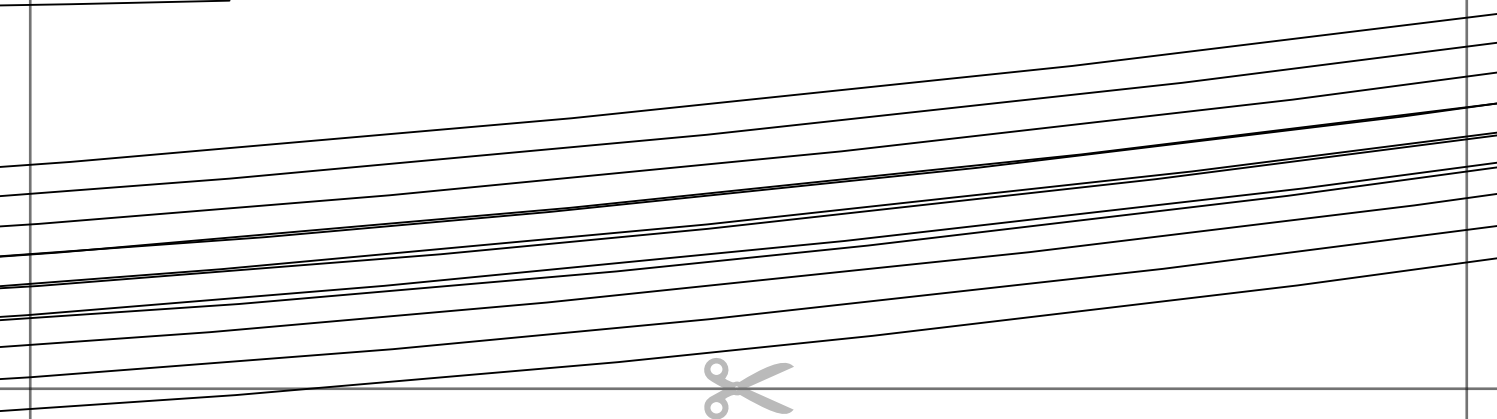

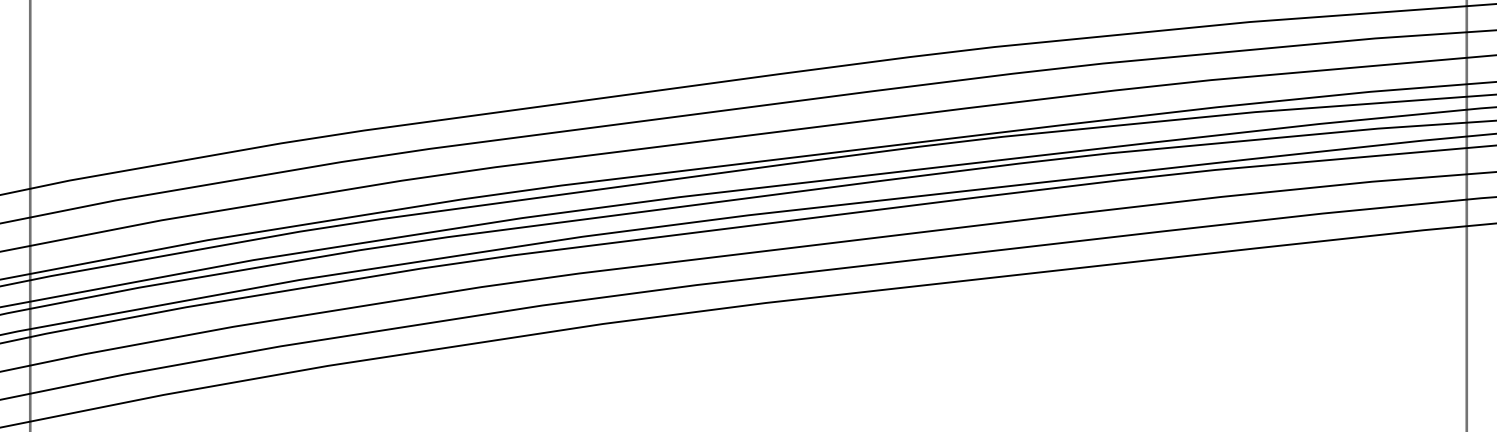

Page 2C

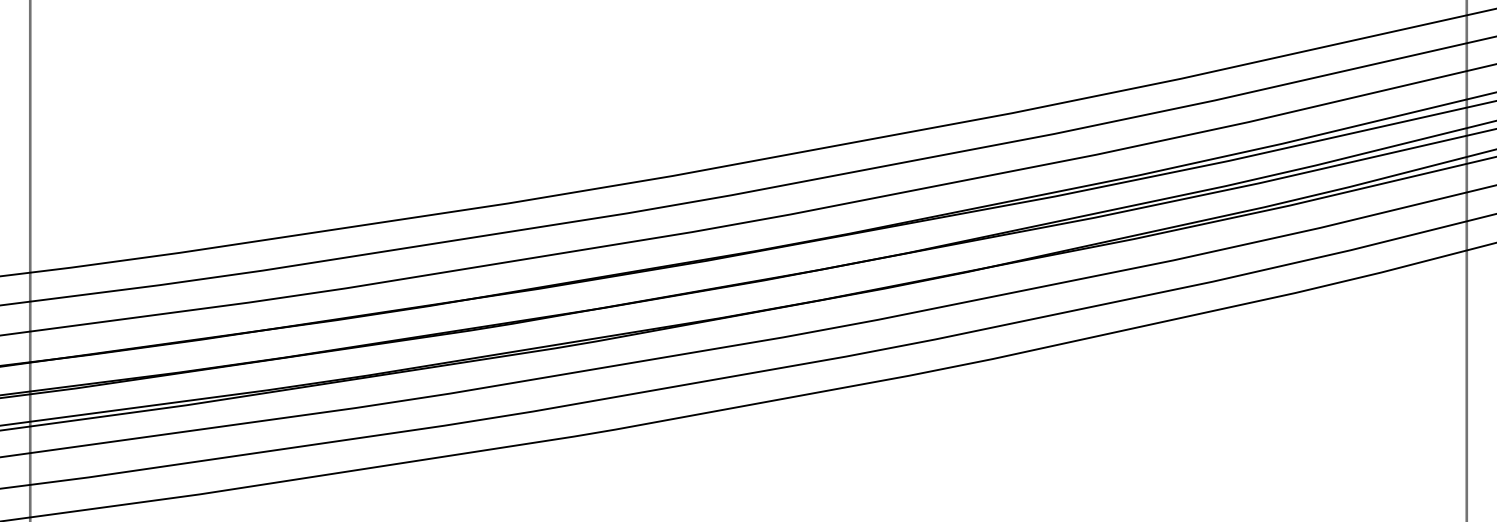



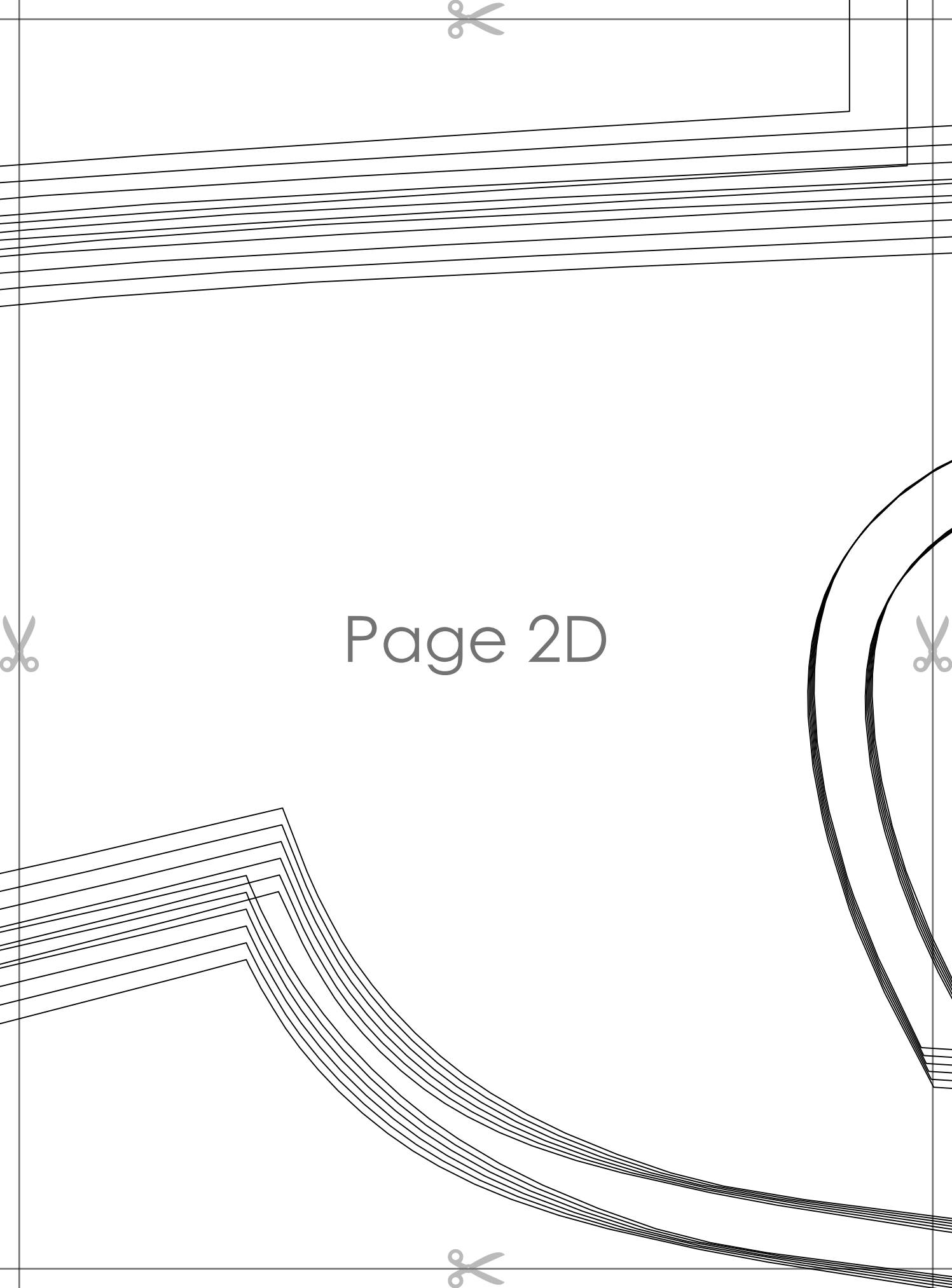

Page 2D



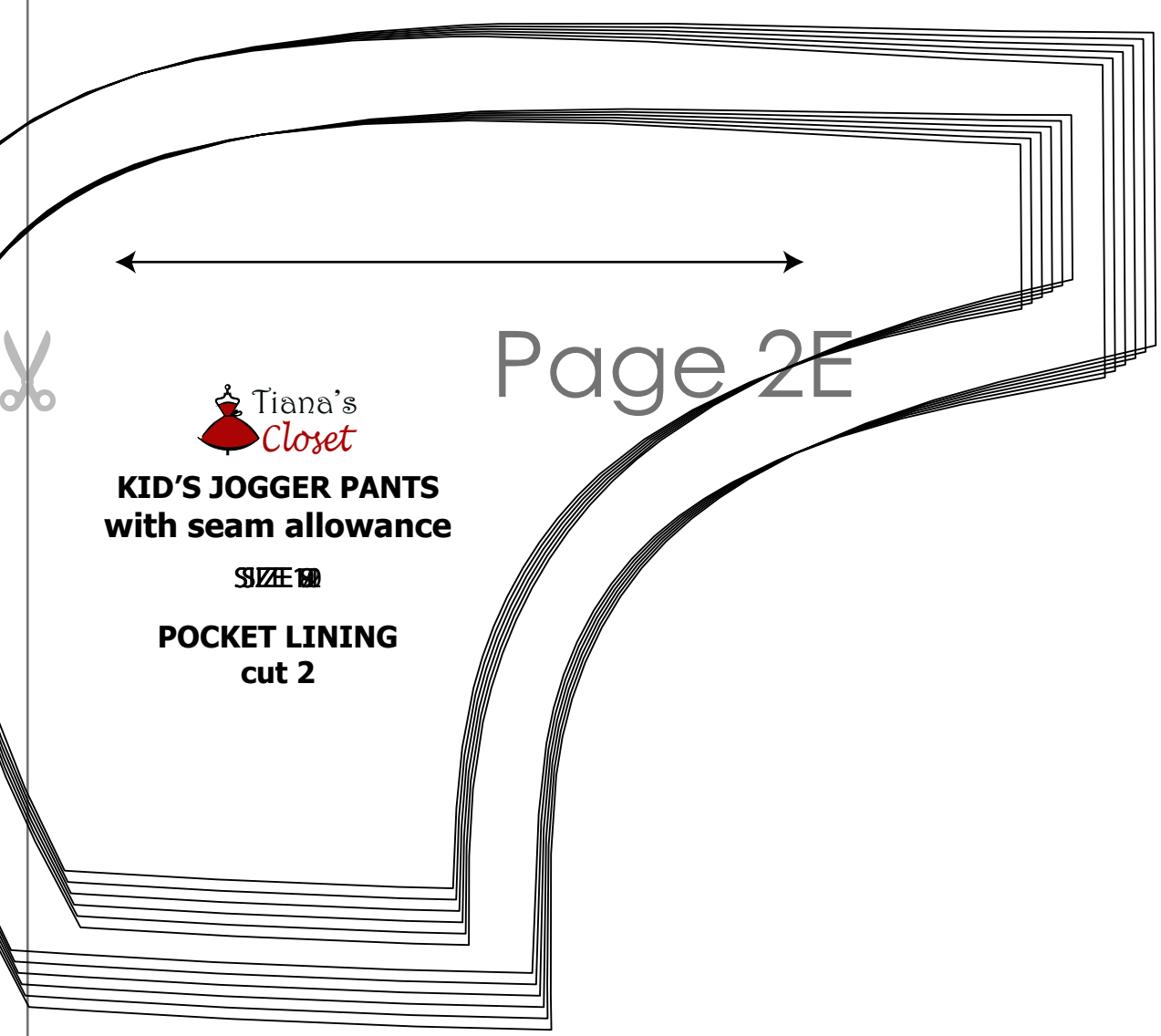
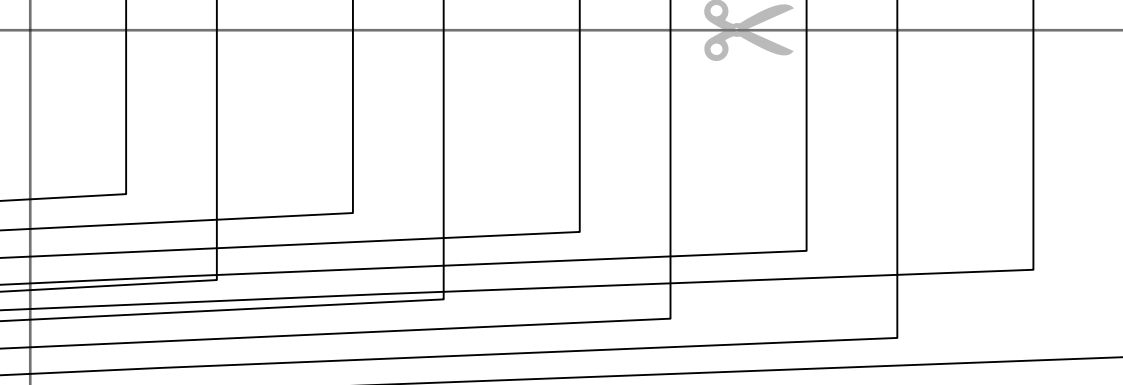

Page 2E



**KID'S JOGGER PANTS  
with seam allowance**

**SIZE 10**

**POCKET LINING  
cut 2**





Page 3A



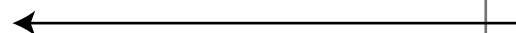

Page 3B





**KID'S JOGGER PANTS  
with seam allowance**

**SIZE 10**

**BACK  
cut 2**

Page 3C





Page 3D



Page 3E





**KID'S JOGGER PANTS  
with seam allowance**

**SIZE ~~10~~**

**PANT CUFF  
cut 2**

Page 3F







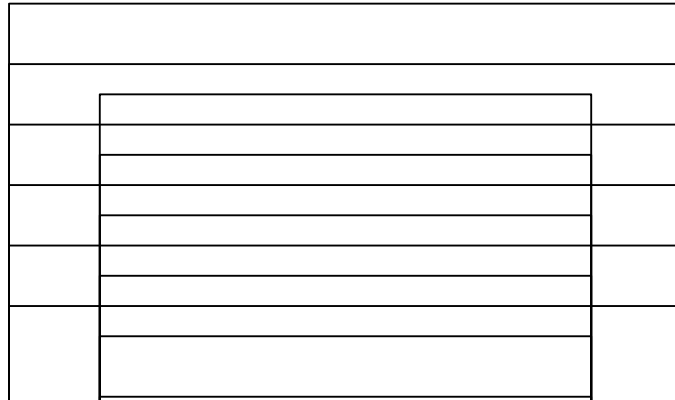

Page 1F



**KID'S JOGGER PANTS  
with seam allowance**

**SIZE 10**

**WAISTBAND  
cut 1 on fold**

